

This hardware design by Olimex LTD is licensed under a Creative Commons Attribution-ShareAlike 3.0 Unported License.

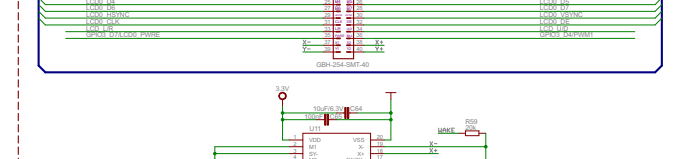

This hardware design by Olimex LTD is licensed under a Creative Commons Attribution-ShareAlike 3.0 Unported License.

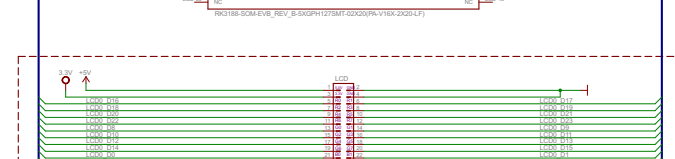
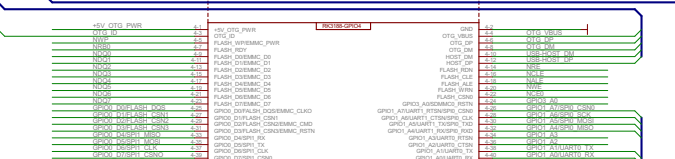
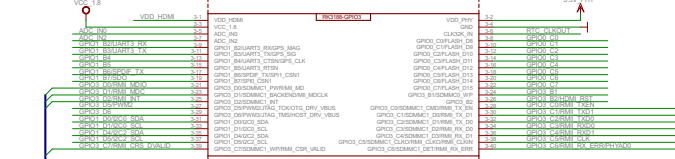
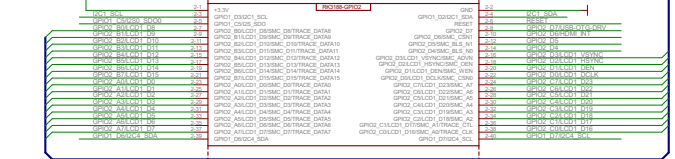
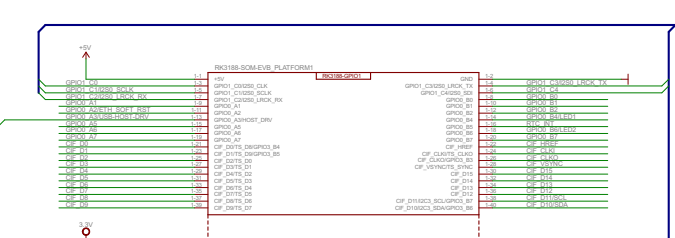
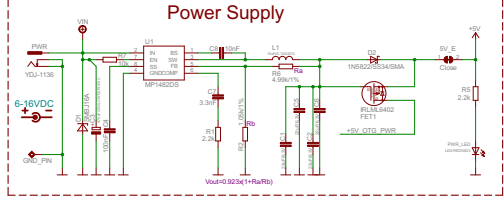
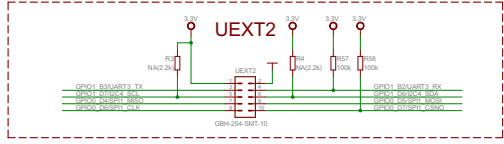
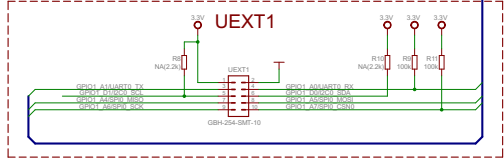
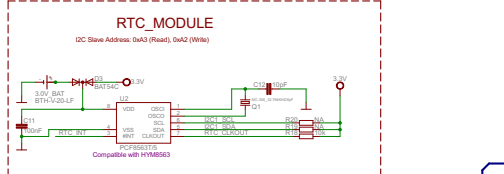
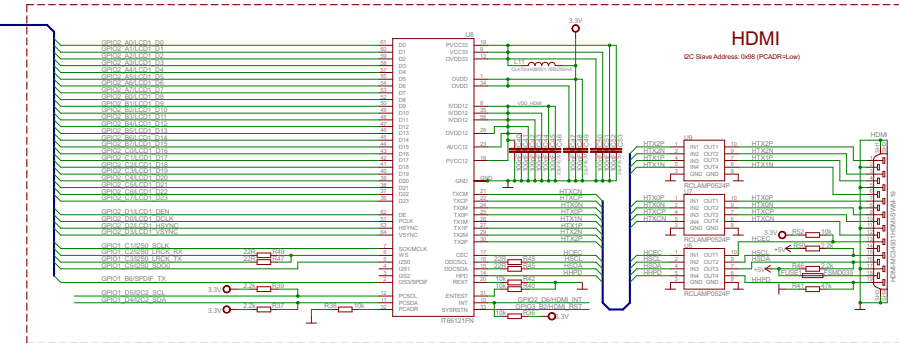

RK3188-EVB, board revision C
 OLIMEX LTD, BULGARIA, 2015
<https://www.OLIMEX.com>

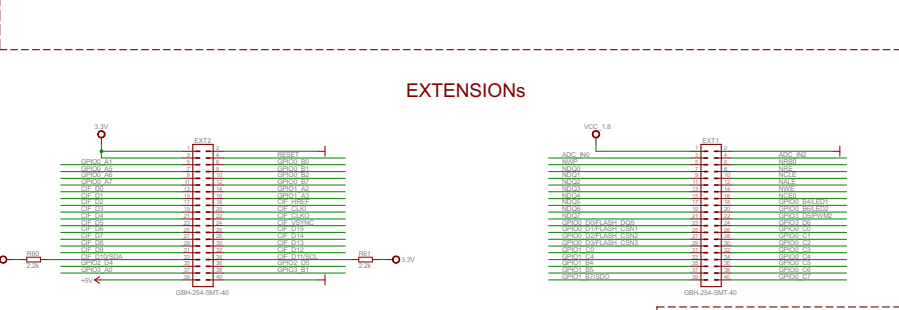
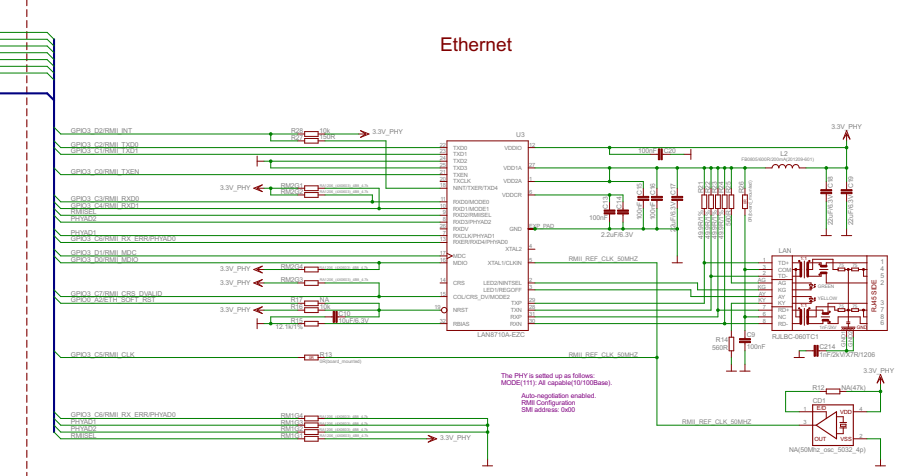

RK3188-EVB, board revision C
 OLIMEX LTD, BULGARIA, 2015
<https://www.OLIMEX.com>