

Power Metal Oxide Resistors
Axial, General propose
Flame retardant coating

**ELECTRICAL SPECIFICATIONS**

Type			PO596-0	PO595-0	PO594-0	PO593-0	PO590-0	PO591-0	
<u>Style</u>			0204	0207	0410	0414	0617	0922	
<u>Nominal Power rating</u>	P ₇₀	[W]	0,5	1	2		3	4	
<u>Resistance range</u>	Min	[Ω]	0R1			0R22	0R22	0R22	
	Max		10M			10M	560K	100K	
<u>E-Series</u>			E24,E96			E24,E48	E24,E96		
<u>Tolerances</u>			± [%]			1, 5	2, 5		
<u>Temperature coefficient</u>			[10 ⁻⁶ *K ⁻¹]			SEE NEXT PAGE			
<u>Temperature range</u>			[°C]			-55...+200		-55...+250	
<u>Thermal resistance</u>			[KW ⁻¹]	260	130	83	83	93	70
<u>Dielectric withstanding voltage</u> <i>IEC115-1 clause 4.7 (1[<i>min</i>])</i>			[V] _{RMS}	300	500				
<u>Max. working voltage</u>			[V] _{RMS}	200	500			750	

PERFORMANCE DATA

<u>Derating linear</u>	[°C]	SEE NEXT PAGE					
<u>Climatic category</u>		55/200/56					
<u>Failure Rate</u> <i>(Total, ρ_o, max, 60% cont. lev.)</i>	[10 ⁻⁹ h ⁻¹]	<10					
<u>Endurance</u> <i>IEC60115-1 clause 4.25 (P₇₀, @ 70[°C], 1000[h])</i>	± [%]	2,0			1,5		
<u>Damp heat, steady state</u> <i>IEC115-1 clause 4.24 (40[°C], 93[% r.h.], 56[d])</i>	± [%]	2,0			1,5		
<u>Climatic sequence</u> <i>IEC115-1 clause 4.23</i>	± [%]				± 1,0		
<u>Terminal strength</u>	± [%]				± 0,3		
<u>Terminal Tensile Strength</u>	[N]	24,5			40		
<u>Resistance to soldering heat</u> <i>IEC115-1 clause 4.18 (260^{±5}[°C], 3,5^{±1}[s])</i>	± [%]				± 0,25		
<u>Solderability</u> <i>IEC 60068-2-20-T (260^{±5}[°C], 53^{±0,5}[s])</i>		Solder bath method (> 95% coverage)					
<u>Current noise</u> <i>IEC60195</i>	[db]	R <15K: -15 R>: 15 +10 /decade					
<u>Nonlinearity</u> <i>IEC60440</i>	[db]	R <15K: 110 R> 15 K: 110 -20 /decade					
<u>Marking</u> <i>IEC60062</i>		colour code, 4/5/6 bands			printed in clear		

DIMENSIONS [mm]

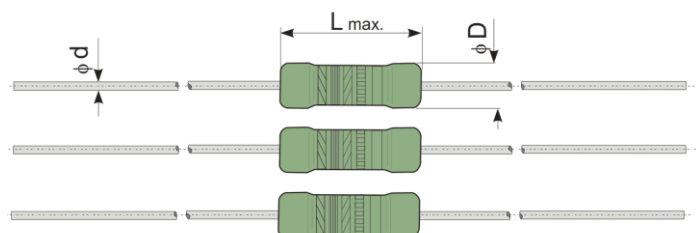

Type	L	Ø D	Ø d
PO596-0	3,4 ^{±0,3}	1,9 ^{±0,2}	0,45 ^{±0,05}
PO595-0	6,3 ^{±0,5}	2,4 ^{±0,2}	0,6 ^{-0,1}
PO594-0	9,0 ^{±0,5}	3,9 ^{±0,3}	0,6 ^{-0,1}
PO593-0	11,5 ^{±1,0}	4,5 ^{±0,5}	0,8 ^{±0,05}
PO590-0	16,5 ^{-1,5}	6,0 ^{-0,5}	0,8 ^{±0,05}
PO591-0	20,0 ⁻¹	9,0 ^{-0,5}	0,8 ^{±0,05}

TEMPERATURE COEFICIENT

PO596-0 R-Value	PO595-0 R-Value	PO594-0 R-Value	PO593-0 R-Value	PO590-0 R-Value	PO591-0 R-Value	E-series	Tolerance	TC [10 ⁻⁶ K ⁻¹]
	-----	-----	0R22 ... 10M	0R22 ... 560K	0R22 ... 100K	E 24	± 5%	± 200
0R1 ... 10M	0R1 ... 10M	0R1 ... 10M	-----	-----	-----	E 24	± 5%	± 100
-----	-----	-----	1R ... 1M	1R ... 100K	1R ... 68K	E 24 / E 48	± 2%	± 200
1R ... 10M	1R ... 10M	1R ... 10M	-----	-----	-----	E 24 / E 96	± 1%	± 50

PERFORMANCE GRAPH'S

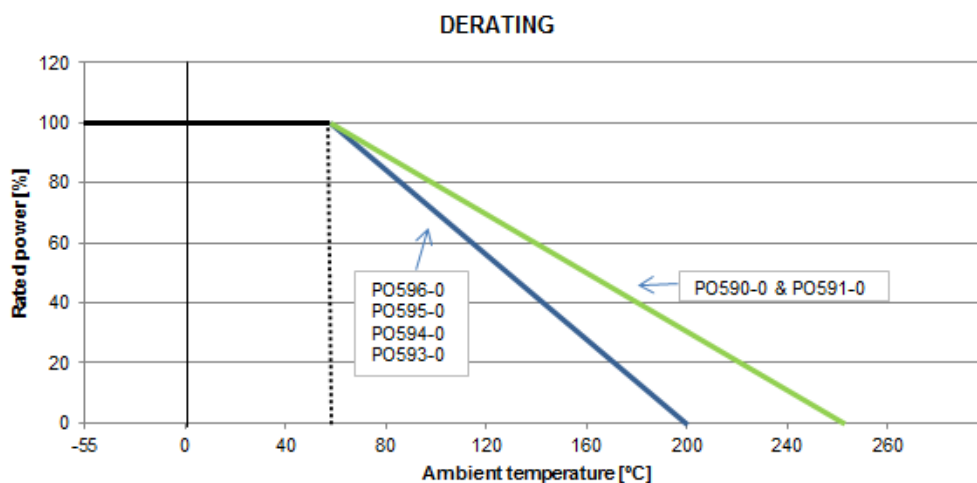

PULSE RATING $P \leq P70$ ($R \geq 10[\Omega]$)

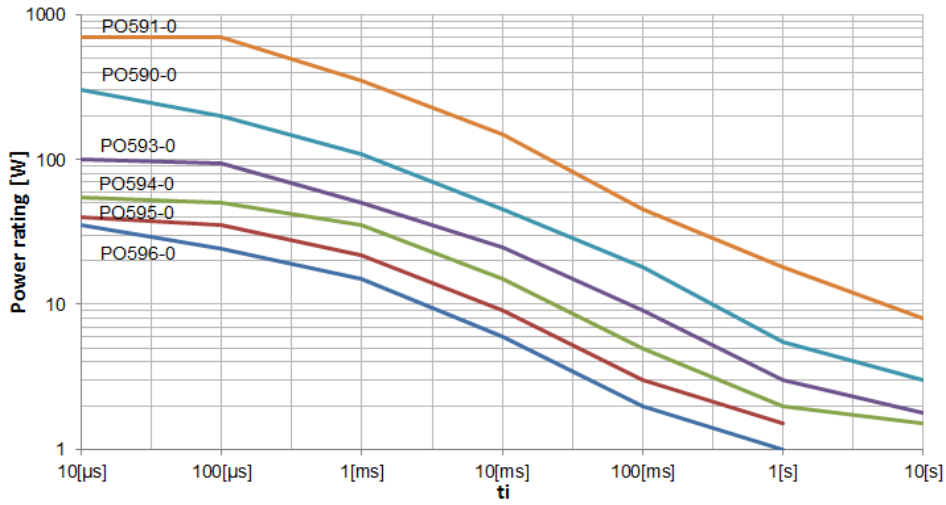

PULSE RATING $P \rightarrow 0$ ($R \geq 10[\Omega]$)

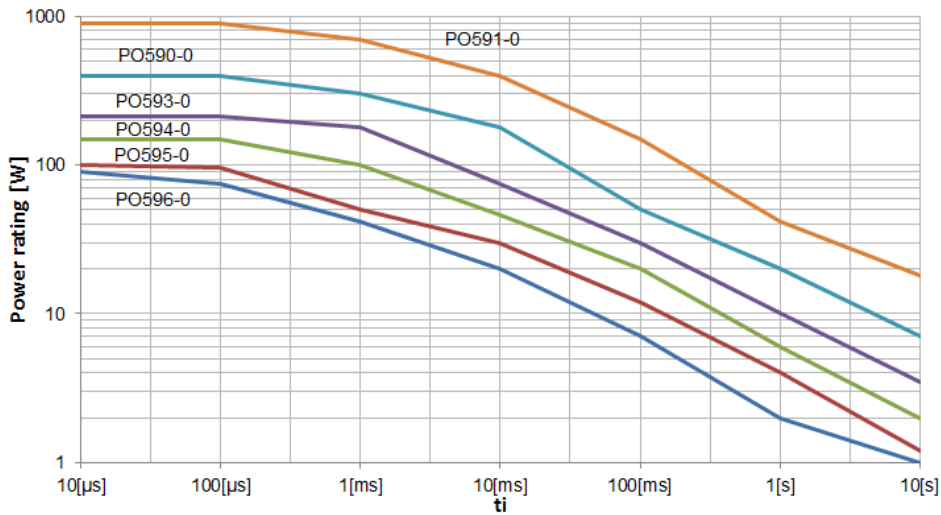

MAXIMUM PULSE VOLTAGE

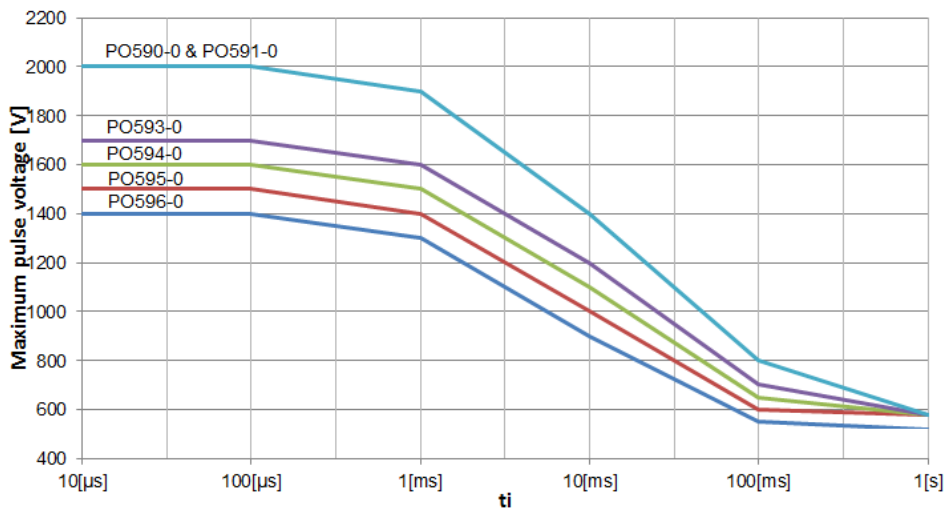

PACKAGING (Dimensions [mm])

The standard packaging for PO in axial type is taped, dimensions below.

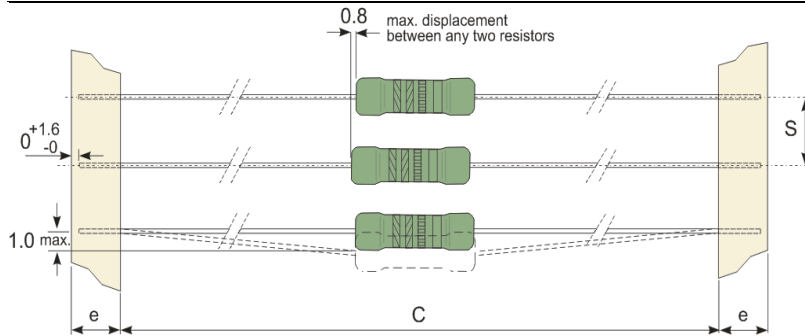

Type	C	S	e
PO596-0	52,4 ±1,0	5 ±0,1	6 ±0,5
PO595-0	52,4 ±1,0	5 ±0,1	6 ±0,5
PO594-0	52,4 ±1,0	5 ±0,1	6 ±0,5
PO593-0	73,0 ±1,5	5 ±0,5	6 ±0,5
PO590-0	83,0 ±1,5	10 ±1,0	9 ±0,5
PO591-0	83,0 ±1,5	10 ±1,0	9 ±0,5

Tape on Box

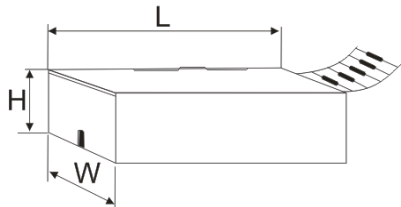

Type	Packaging	Pieces	Pack. Code	Box Dimensions		
				W	H	L
PO596-0	Taped / Ammo pack	5.000	T	81	70	260
PO595-0		5.000		81	104	260
PO594-0		1.000		73	45	258
PO593-0		1.000		103	78	260
PO590-0		1.000		115	93	405
PO591-0		500		118	110	412

Tape in reel

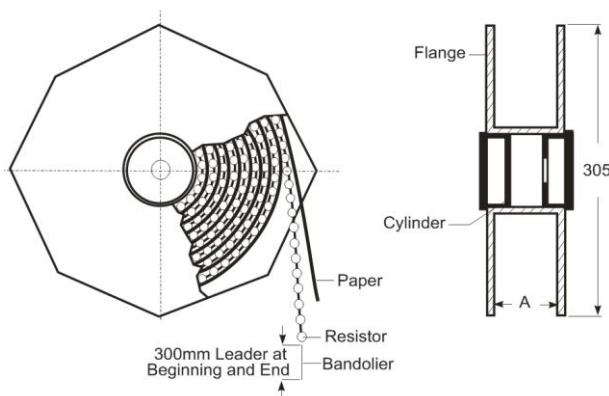

Type	Packaging	Pieces	Pack. Code	Across Flange (A)
PO596-0	Taped / Reel	5.000	R	72
PO595-0		5.000		
PO594-0		2.500		95
PO593-0		2.000		
PO590-0		1.500		105
PO591-0		1.000		

ALTERNATIVE LEAD CONFIGURATIONS

This type PO, is also available in a different pre-forming, as shown below, other's upon request.

SMD VERSION

Z – form

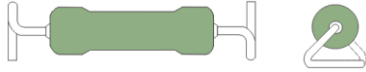

Please check the details here <http://www.vitrohm.com/>

THROUGH HOLE VERSION

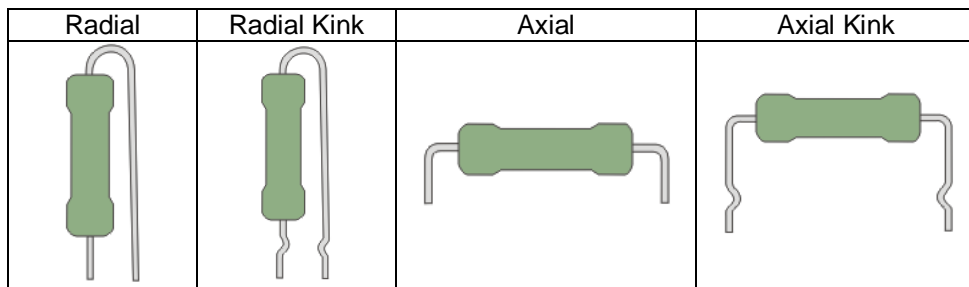

*For horizontal and vertical pre-forming please consult your local sales contact.

ORDERING EXAMPLE

PO596-0	5	T	150R
<i>Type</i>	<i>Tolerance</i>	<i>Pack-Code</i>	
		<i>T</i>	<i>Ammo pack</i>
		<i>R</i>	<i>Reel</i>