

PCB RISING CLAMP TERMINAL BLOCKS

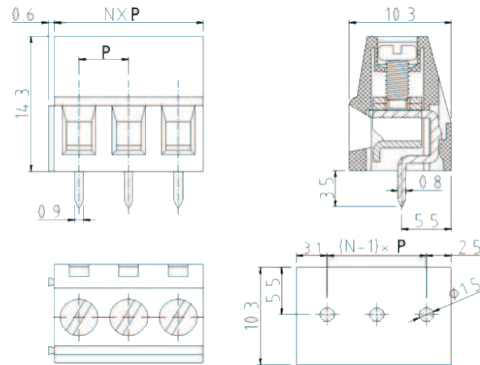

EG128V-5.0/5.08

Pitch: 5.0 mm, 5.08mm



N: Number of poles P: Pitch

Standard	UL	IEC
Rated voltage	300V	250V
Rated current	15A	18A
Wire range	24-12AWG	2.5mm ²
Withstanding voltage	AC2000V/1Min	
Torque	0.4Nm(3.5Lb-In.)	
Ambient temperature	-40°C~+105°C	
Strip length	7mm	
Pitch	5.0mm(.197"), 5.08mm(.200")	
Poles	2P, 3P-24P	
Housing	PA66, UL94V-0	
Screws	M2.5, steel, Cr ³⁺ Zn plated	
Pin header	Brass, Tin plated	
Cage	Brass, Ni plated	

HOW TO ORDER

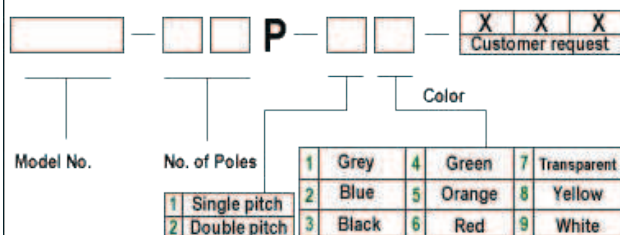

EG:

