

Data sheet | Item number: 222-415

CLASSIC Splicing Connector; for all conductor types; max. 4 mm²; 5-conductor; with levers; gray housing; Surrounding air temperature: max 40° C; 2,50 mm²; gray

www.wago.com/222-415

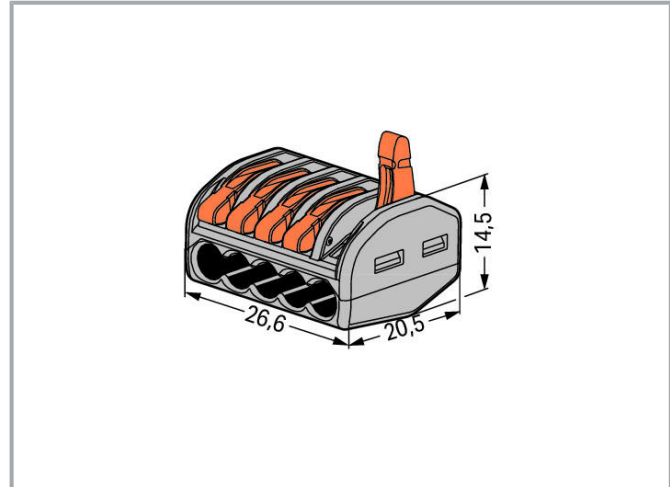

Item description

Safety information 1:
in grounded power lines

Data

Electrical data

Ratings per IEC/EN

Ratings per	EN 60664
Nominal voltage (II/2)	400 V
Rated surge voltage (II/2)	4 kV
Rated current	32 A
Legend (ratings)	(II / 2) ≙ Overvoltage category II / Pollution degree 2

Connection data

Connection technology

Subject to changes. Please also observe the further product documentation!

WAGO Kontakttechnik GmbH & Co. KG
Hansastr. 27
32423 Minden
Phone: +49571 887-0 | Fax: +49571 887-169
Email: info.de@wago.com | Web: www.wago.com

Do you have any questions about our products?
We are always happy to take your call at +49 (571) 887-44222.



	CAGE CLAMP®
Actuation type	Lever
Connectable conductor materials	Copper
Solid conductor	0.08 ... 2.5 mm ² / 28 ... 12 AWG
Stranded conductor	0.08 ... 2.5 mm ² / 28 ... 12 AWG
Fine-stranded conductor	0.08 ... 4 mm ² / 28 ... 12 AWG
Strip length	9 ... 10 mm / 0.35 ... 0.39 inch
Total number of connection points	5
Total number of potentials	1
Wiring type	Side-entry wiring

Physical data

Width	26.6 mm / 1.047 inch
Height	14.5 mm / 0.571 inch
Depth	20.5 mm / 0.807 inch

Material data

Color	gray
Flammability class per UL94	V0
Fire load	0.13 MJ
Color of actuator	orange
Weight	6.6 g

Environmental requirements

Surrounding air temperature (operation)	40 °C
Continuous operating temperature	85 °C

Commercial data

Product Group	7 (Push Wire Conn.)
Packaging type	BOX
Country of origin	DE
GTIN	4044918464956
Customs tariff number	85369010000

Approvals / Certificates

Country specific Approvals



Subject to changes. Please also observe the further product documentation!

WAGO Kontakttechnik GmbH & Co. KG
 Hansastr. 27
 32423 Minden
 Phone: +49571 887-0 | Fax: +49571 887-169
 Email: info.de@wago.com | Web: www.wago.com



Do you have any questions about our products?
 We are always happy to take your call at +49 (571) 887-44222.

Logo	Approval	Additional Approval Text	Certificate name
	ENEC 15 UL International Demko A/S	EN 60998	ENEC-01360

Ship Approvals

Logo	Approval	Additional Approval Text	Certificate name
	ABS American Bureau of Shipping	-	18-HG1755093-PDA
	DNV GL Det Norske Veritas, Germanischer Lloyd	EN 60998	TAE000015T
	LR Lloyds Register	EN 60998	04/20013 (E8)

UL-Approvals

Logo	Approval	Additional Approval Text	Certificate name
	UL UL International Germany GmbH	UL 486C	E69654
	UL Underwriters Laboratories Inc.	UL 467	E201573

Compatible products

Mounting adapter

	Item no.: 222-500 Mounting carrier; 222 Series; for DIN-35 rail mounting/screw mounting; orange	www.wago.com/222-500
---	--	--

Subject to changes. Please also observe the further product documentation!



Downloads

Documentation

Bid Text

222-415 X81 - Datei	Feb 19, 2019	xml 3.5 kB	Download
------------------------	--------------	---------------	----------

222-415 docx - Datei	Jan 23, 2019	docx 15.8 kB	Download
-------------------------	--------------	-----------------	----------

Additional Information

Technical explanations	Apr 3, 2019	pdf 2.2 MB	Download
------------------------	-------------	---------------	----------

CAD/CAE-Data

CAE data

EPLAN Data Portal 222-415	URL	Download
---------------------------	-----	----------

WSCAD Universe 222-415	URL	Download
------------------------	-----	----------

ZUKEN Portal 222-415	URL	Download
----------------------	-----	----------

CAD data

2D/3D Models 222-415	URL	Download
----------------------	-----	----------

Environmental Product Compliance

Compliance Search

Environmental Product Compliance 222-415 CLASSIC Splicing Connector; for all conductor types; max. 4 mm ² ; 5-conductor; with levers; gray housing; Surrounding air temperature: max 40°C; 2,50 mm ² ; gray	URL	Download
--	-----	----------

Installation Notes

Conductor termination

Subject to changes. Please also observe the further product documentation!

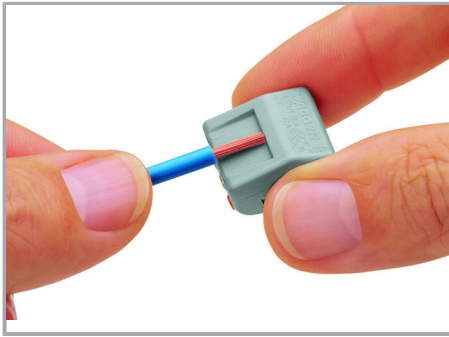

Strip conductor to 9 ... 10 mm (0.35 ... 0.39 inch).

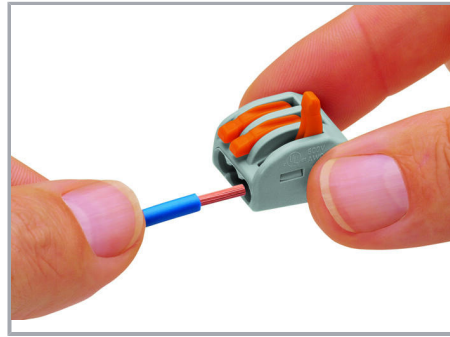

Termination: Lift the lever to open the clamping unit and insert a stripped conductor.

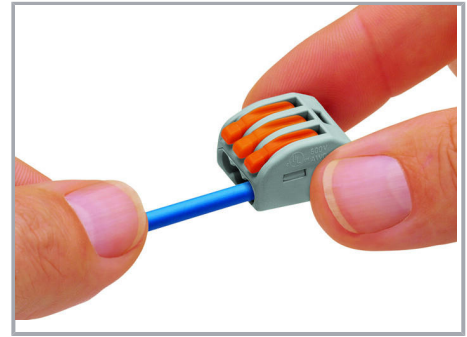

Then, lower the lever to close the clamp.

Testing

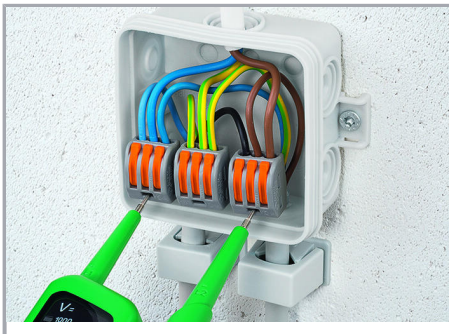

Testing via Profi-LED+ voltage tester (206-806).

Application

Subject to changes. Please also observe the further product documentation!

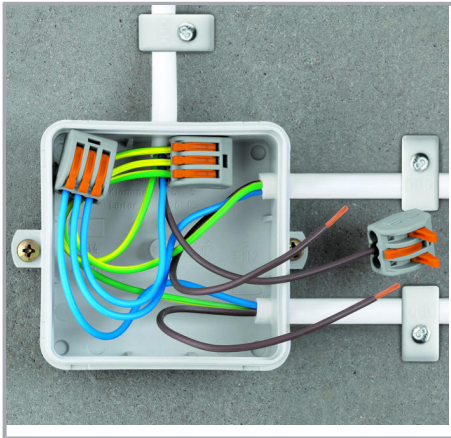

Wiring fine-stranded conductors in junction boxes.

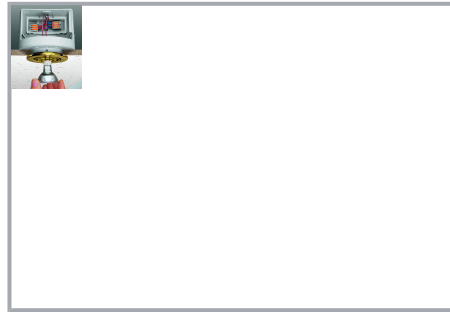

Custom low-voltage lighting system

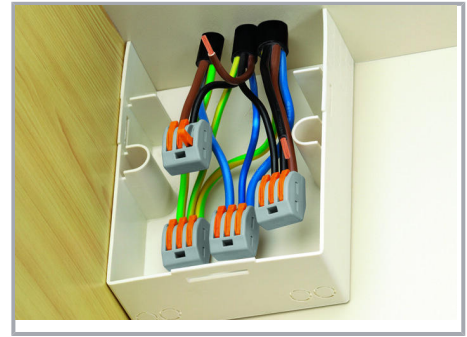

Connecting pre-wired and pre-fabricated components (e.g., in mobile homes).

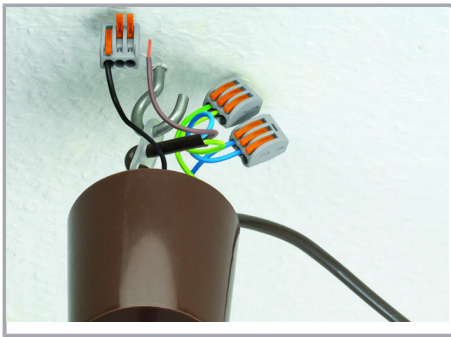

Lighting fixture connection with fine-stranded wires and power feed

Subject to changes. Please also observe the further product documentation!



Compact, lever-operated splicing connectors:

They connect up to five stripped, fine-stranded conductors from 0.08 to 4 mm² (28 ... 12 AWG), as well as solid or stranded conductors from up to 2.5 mm² (12 AWG) – without tools!

How they work:

Pull up one of the orange operating levers to open the clamping unit so that the lever engages and keeps the clamp in its opened position. Then insert the conductor and push the lever back down, flush with the connector housing.

Safety:

The lever's specially designed rest position reliably prevents accidental unclamping of a connected conductor. Application safety, for any type of conductor (solid, stranded, fine-stranded), is confirmed by approvals like ENEC or UL.

ENEC is the European mark for electrical products that demonstrates compliance with European safety standards. The ENEC mark is subjected to the same EN standards as the VDE mark.

While the VDE mark is only permitted in Germany, the ENEC mark is accepted in more than 20 European countries.

Subject to changes. Please also observe the further product documentation!