

## Data sheet | Item number: 773-173

PUSH WIRE® connector for junction boxes; for solid and stranded conductors; max. 6 mm<sup>2</sup>; 3-conductor; transparent housing; red cover; Surrounding air temperature: max 60°C; 6,00 mm<sup>2</sup>; multicoloured

[www.wago.com/773-173](http://www.wago.com/773-173)

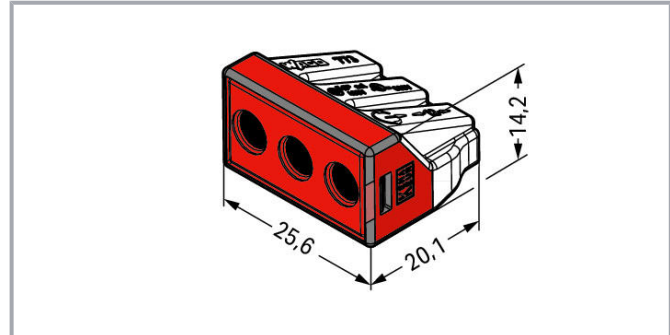
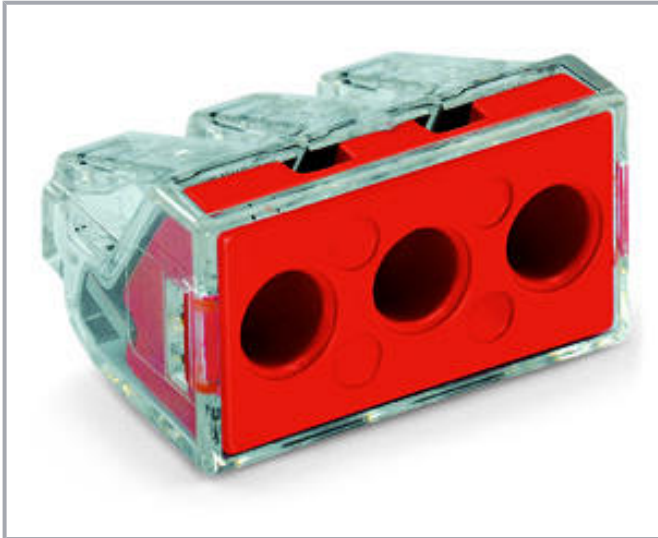

## Item description

### Note:

#### Terminating Aluminum Conductors

WAGO spring clamp terminal blocks are suitable for solid aluminum conductors up to 4 mm<sup>2</sup>/12 AWG if WAGO "Alu-Plus" Contact Paste is used for termination.

#### "Alu-Plus" Contact Paste Advantages:

- Automatically destroys the oxide film during clamping.
- Prevents fresh oxidation at the clamping point.
- Prevents electrolytic corrosion between aluminum and copper conductors (in the same terminal block).
- Provides long-term protection against corrosion.

For spring clamp connections with PUSH WIRE® connection technology, **WAGO recommends that the aluminum conductor first be cleaned** and then immediately inserted into the clamping unit filled with "Alu-Plus" contact paste.

It is also possible to apply WAGO "Alu-Plus" **additionally** on the whole surface of the aluminum conductor before termination.

Please note that the nominal currents must be adapted to the reduced conductivity of the aluminum conductors::

2.5 mm<sup>2</sup> = 16 A

4 mm<sup>2</sup> = 22 A

Subject to changes. Please also observe the further product documentation!

WAGO Kontakttechnik GmbH & Co. KG  
Hansastr. 27  
32423 Minden  
Phone: +49571 887-0 | Fax: +49571 887-169  
Email: [info.de@wago.com](mailto:info.de@wago.com) | Web: [www.wago.com](http://www.wago.com)

Do you have any questions about our products?  
We are always happy to take your call at +49 (571) 887-44222.



**Safety information 1:**  
in grounded power lines

## Data

### Electrical data

#### Ratings per IEC/EN

Ratings per	IEC/EN 60664-1
Nominal voltage (II/2)	400 V
Rated surge voltage (II/2)	4 kV
Rated current	41 A
Legend (ratings)	(II / 2) $\triangleq$ Overvoltage category II / Pollution degree 2

#### Connection data

Connection technology	PUSH WIRE <sup>®</sup>
Actuation type	Push-in
Connectable conductor materials	Copper Aluminum
Solid conductor	2.5 ... 6 mm <sup>2</sup> / 14 ... 10 AWG
Stranded conductor	2.5 ... 6 mm <sup>2</sup> / 14 ... 10 AWG
Strip length	12 ... 13 mm / 0.47 ... 0.51 inch
Total number of connection points	3
Total number of potentials	1
Wiring type	Side-entry wiring

#### Physical data

Width	25.6 mm / 1.008 inch
Height	14.2 mm / 0.559 inch
Depth	20.1 mm / 0.791 inch

#### Material data

Color	multicoloured
Cover color	red
Flammability class per UL94	V2
Fire load	0.115 MJ
Weight	5.8 g

Subject to changes. Please also observe the further product documentation!

WAGO Kontakttechnik GmbH & Co. KG  
Hansastr. 27  
32423 Minden  
Phone: +49571 887-0 | Fax: +49571 887-169  
Email: [info.de@wago.com](mailto:info.de@wago.com) | Web: [www.wago.com](http://www.wago.com)

Do you have any questions about our products?  
We are always happy to take your call at +49 (571) 887-44222.

## Environmental requirements



Surrounding air temperature (operation)	60 °C
Continuous operating temperature	105 °C

## Commercial data

Packaging type	BOX
Country of origin	CN
GTIN	4050821215141
Customs tariff number	85369010000

## Approvals / Certificates

### Country specific Approvals

Logo	Approval	Additional Approval Text	Certificate name
	CSA DEKRA Certification B.V.	C22.2	15411 (LR46759)
	ENEC 15 UL International Germany GmbH	EN 60998	ENEC- 01207

### Ship Approvals

Logo	Approval	Additional Approval Text	Certificate name
	ABS American Bureau of Shipping	-	18- HG1755093- PDA

### UL-Approvals

Logo	Approval	Additional Approval Text	Certificate name
	UL UL International Germany GmbH	UL 486C	E69654

Subject to changes. Please also observe the further product documentation!

## Compatible products

### General accessories

	Item no.: 249-130 Syringe; Contents: 20 ml Alu-Plus contact paste	<a href="http://www.wago.com/249-130">www.wago.com/249-130</a>
--	--	--

### Mounting adapter

	Item no.: 773-332 Mounting carrier; 773 Series - 2.5 mm <sup>2</sup> / 4 mm <sup>2</sup> / 6 mm <sup>2</sup> ; for DIN-35 rail mounting/screw mounting; orange	<a href="http://www.wago.com/773-332">www.wago.com/773-332</a>
--	---	--

## Downloads

### Documentation

#### Bid Text

773-173 doc - Datei	May 17, 2017	doc 25.6 kB	Download
------------------------	--------------	----------------	----------

773-173 X81 - Datei	Feb 19, 2019	xml 3.3 kB	Download
------------------------	--------------	---------------	----------

#### Additional Information

Technical explanations	Apr 3, 2019	pdf 2.2 MB	Download
------------------------	-------------	---------------	----------

## CAD/CAE-Data

### CAD data

2D/3D Models 773-173	URL	Download
----------------------	-----	----------

### CAE data

EPLAN Data Portal 773-173	URL	Download
---------------------------	-----	----------

WSCAD Universe 773-173	URL	Download
------------------------	-----	----------

ZUKEN Portal 773-173	URL	Download
----------------------	-----	----------

## Environmental Product Compliance

### Compliance Search

Environmental Product Compliance 773-173	URL	Download
--	-----	----------

Subject to changes. Please also observe the further product documentation!



PUSH WIRE® connector for junction boxes; for solid and stranded conductors; max. 6 mm<sup>2</sup>; 3-conductor; transparent housing; red cover; Surrounding air temperature: max 60°C; 6,00 mm<sup>2</sup>; multicoloured

---

## Installation Notes

Subject to changes. Please also observe the further product documentation!

---

WAGO Kontakttechnik GmbH & Co. KG  
Hansastr. 27  
32423 Minden  
Phone: +49571 887-0 | Fax: +49571 887-169  
Email: [info.de@wago.com](mailto:info.de@wago.com) | Web: [www.wago.com](http://www.wago.com)

Do you have any questions about our products?  
We are always happy to take your call at +49 (571) 887-44222.