

Data sheet | Item number: 231-140/001-000

THT male header; 1.0 x 1.0 mm solder pin; straight; Pin spacing 5 mm; 10-pole; gray

www.wago.com/231-140/001-000

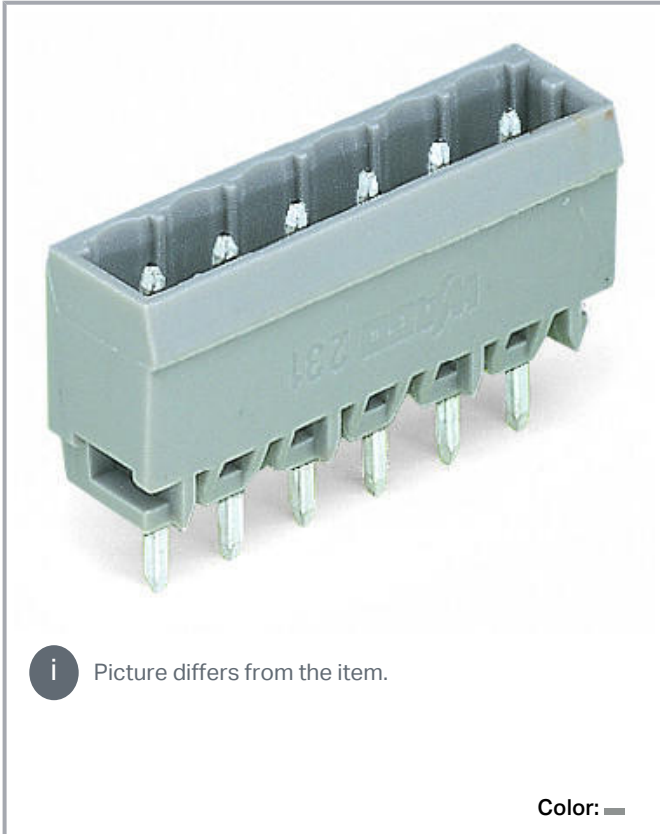

i Picture differs from the item.

Color: —

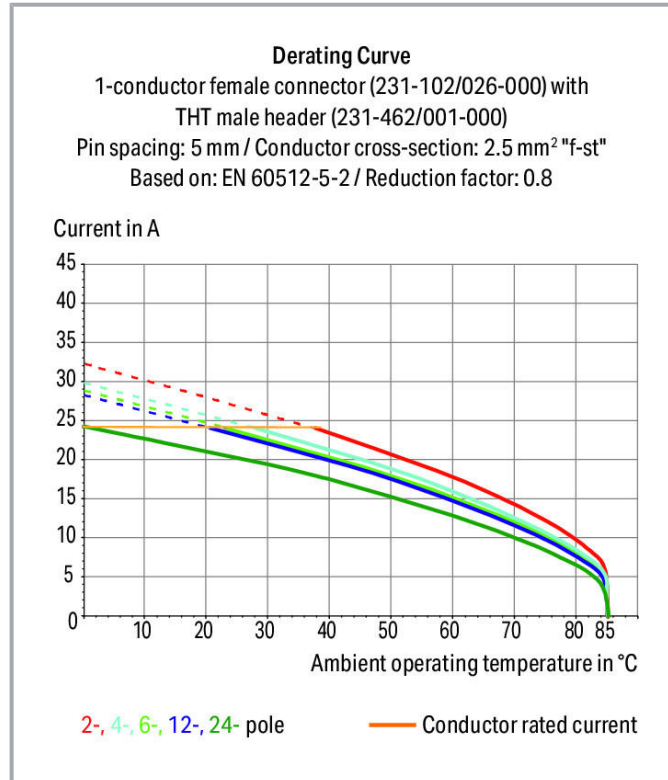

Subject to changes. Please also observe the further product documentation!

WAGO Kontakttechnik GmbH & Co. KG
Hansastr. 27
32423 Minden
Phone: +49571 887-0 | Fax: +49571 887-169
Email: info.de@wago.com | Web: www.wago.com

Do you have any questions about our products?
We are always happy to take your call at +49 (571) 887-44222.

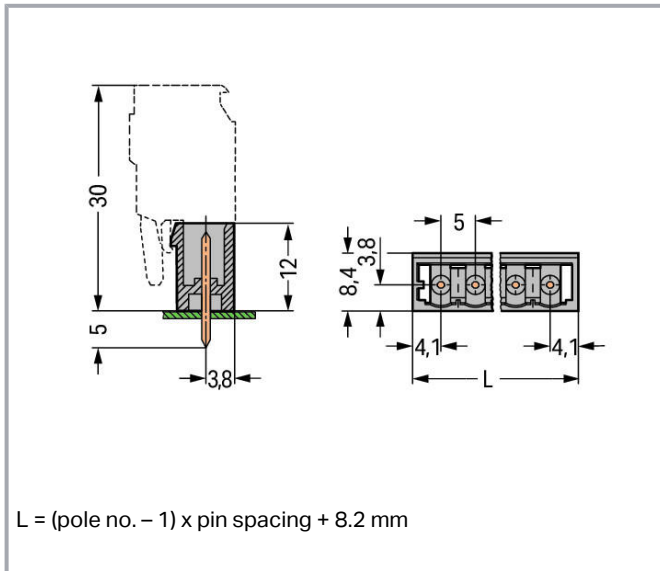

Item description

- Horizontal or vertical PCB mounting via straight or angled solder pins
- Pin cross-section: 1 x 1 mm
- With coding fingers

Safety information 1:

The MCS – MULTI CONNECTION SYSTEM includes connectors without breaking capacity in accordance with DIN EN 61984. When used as intended, these connectors must not be connected/disconnected when live or under load. The circuit design should ensure header pins, which can be touched, are not live when unmated.

Data

Electrical data

Ratings per IEC/EN

Ratings per	IEC/EN 60664-1
Nominal voltage (III/3)	320 V
Rated surge voltage (III/3)	4 kV
Rated voltage (III/2)	320 V
Rated surge voltage (III/2)	4 kV
Nominal voltage (II/2)	630 V
Rated surge voltage (II/2)	4 kV
Rated current	12 A

Subject to changes. Please also observe the further product documentation!



Legend (ratings)

(III / 2) ≙ Overvoltage category III / Pollution degree 2

Ratings per UL

Approvals per	UL 1059
Rated voltage UL (Use Group B)	300 V
Rated current UL (Use Group B)	10 A
Rated voltage UL (Use Group D)	300 V
Rated current UL (Use Group D)	10 A

Ratings per UL

Rated voltage UL 1977	600 V
Rated current UL 1977	10 A

Ratings per CSA

Approvals per	CSA
Rated voltage CSA (Use Group B)	300 V
Rated current CSA (Use Group B)	10 A
Rated voltage CSA (Use Group D)	300 V
Rated current CSA (Use Group D)	10 A

Connection data

Pole No.	10
Total number of potentials	10
Number of connection types	1
Number of levels	1

Physical data

Pin spacing	5 mm / 0.197 inch
Width	53.2 mm / 2.094 inch
Height	17 mm / 0.669 inch
Height from the surface	12 mm / 0.472 inch
Depth	8.4 mm / 0.331 inch
Solder pin length	5 mm
Solder pin dimensions	1 x 1 mm
Drilled hole diameter with tolerance	1.4 ^(+0.1) mm

Subject to changes. Please also observe the further product documentation!

WAGO Kontakttechnik GmbH & Co. KG
 Hansastr. 27
 32423 Minden
 Phone: +49571 887-0 | Fax: +49571 887-169
 Email: info.de@wago.com | Web: www.wago.com

Do you have any questions about our products?
 We are always happy to take your call at +49 (571) 887-44222.



Plug-in connection

Contact type (pluggable connector)	Male connector/plug
Connector (connection type)	for PCB
Mismating protection	No
Mating direction to the PCB	90°

PCB contact

PCB Contact	THT
Solder pin arrangement	over the entire male connector (in-line)
Number of solder pins per potential	1

Material data

Color	gray
Material group	I
Insulation material	Polyamide (PA66)
Flammability class per UL94	V0
Contact material	Electrolytic copper (E _{Cu})
Contact plating	tin-plated
Fire load	0.057 MJ
Weight	3.2 g

Environmental requirements

Limit temperature range	-60 ... +100 °C
-------------------------	-----------------

Commercial data

Product Group	3 (Multi Conn. System)
Packaging type	BOX
Country of origin	DE
GTIN	4044918863490
Customs tariff number	85366990990

Approvals / Certificates

Country specific Approvals

Logo	Approval	Additional Approval Text	Certificate name
	CB	IEC 61984	NL-39756

Subject to changes. Please also observe the further product documentation!

WAGO Kontakttechnik GmbH & Co. KG
 Hansastr. 27
 32423 Minden
 Phone: +49571 887-0 | Fax: +49571 887-169
 Email: info.de@wago.com | Web: www.wago.com

Do you have any questions about our products?
 We are always happy to take your call at +49 (571) 887-44222.

DEKRA Certification B.V.





CSA
DEKRA Certification B.V.

C22.2

LR 18677-
25



Ship Approvals

Logo	Approval	Additional Approval Text	Certificate name
	ABS American Bureau of Shipping	-	19- HG1869876- PDA
	BV Bureau Veritas S.A.	IEC 60998	11915/D0 BV
	DNV GL Det Norske Veritas, Germanischer Lloyd	-	TAE000016Z









UL-Approvals

Logo	Approval	Additional Approval Text	Certificate name
	UL Underwriters Laboratories Inc.	UL 1059	20190731- E45172

Counterpart

	Item no.231-110/026-000 1-conductor female connector; 2.5 mm ² ; Pin spacing 5 mm; 10-pole; 2,50 mm ² ; gray	www.wago.com/231-110/026-000
	Item no.231-2110/026-000 2-conductor female connector; with integrated end plate; 2.5 mm ² ; Pin spacing 5 mm; 10-pole; 2,50 mm ² ; gray	www.wago.com/231-2110/026-000
	Item no.231-2110/037-000 2-conductor female connector; Locking lever; 2.5 mm ² ; Pin spacing 5 mm; 10-pole; 2,50 mm ² ; gray	www.wago.com/231-2110/037-000
	Item no.2231-110/031-000 1-conductor female connector; push-button; clamping collar; 2.5 mm ² ; Pin spacing 5 mm; 10-pole; 2,50 mm ² ; gray	www.wago.com/2231-110/031-000

Subject to changes. Please also observe the further product documentation!



	Item no.2231-110/037-000 1-conductor female connector; push-button; Locking lever; 2.5 mm²; Pin spacing 5 mm; 10-pole; 2,50 mm²; gray	www.wago.com/2231-110/037-000
	Item no.2231-110/102-000 1-conductor female connector; push-button; with integrated end plate; 2.5 mm²; Pin spacing 5 mm; 10-pole; 2,50 mm²; gray	www.wago.com/2231-110/102-000
	Item no.2231-110/026-000 1-conductor female connector; push-button; 2.5 mm²; Pin spacing 5 mm; 10-pole; 2,50 mm²; gray	www.wago.com/2231-110/026-000
	Item no.231-110/027-000 1-conductor female connector; clamping collar; 2.5 mm²; Pin spacing 5 mm; 10-pole; 2,50 mm²; gray	www.wago.com/231-110/027-000
	Item no.231-110/031-000 1-conductor female connector; clamping collar; 2.5 mm²; Pin spacing 5 mm; 10-pole; 2,50 mm²; gray	www.wago.com/231-110/031-000
	Item no.231-110/037-000 1-conductor female connector; Locking lever; 2.5 mm²; Pin spacing 5 mm; 10-pole; 2,50 mm²; gray	www.wago.com/231-110/037-000
	Item no.231-110/102-000 1-conductor female connector; with integrated end plate; 2.5 mm²; Pin spacing 5 mm; 10-pole; 2,50 mm²; gray	www.wago.com/231-110/102-000
	Item no.232-210/026-000 1-conductor female connector; angled; 2.5 mm²; Pin spacing 5 mm; 10-pole; 2,50 mm²; gray	www.wago.com/232-210/026-000
	Item no.232-110/026-000 1-conductor female connector; angled; 2.5 mm²; Pin spacing 5 mm; 10-pole; 2,50 mm²; gray	www.wago.com/232-110/026-000

Compatible products

tools

	Item no.: 209-132 Operating tool; for connecting comb-style jumper bar; 2-way; of insulating material	www.wago.com/209-132
---	---	--

Marking accessories

	Item no.: 210-833 Marking strips; on reel; 6 mm wide; plain; Self-adhesive; white	www.wago.com/210-833
	Item no.: 210-834 Marking strips; on reel; 5 mm wide; plain; Self-adhesive; white	www.wago.com/210-834

Coding

	Item no.: 231-129 Coding key; snap-on type; light gray	www.wago.com/231-129
	Item no.: 231-500 Spacer; for formation of groups; light gray	www.wago.com/231-500

Subject to changes. Please also observe the further product documentation!



Downloads

Documentation

Additional Information

Technical explanations	Apr 3, 2019	pdf 2.0 MB	Download
------------------------	-------------	---------------	----------

CAD/CAE-Data

CAD data

2D/3D Models 231-140/001-000	URL	Download
------------------------------	-----	----------

CAE data

EPLAN Data Portal 231-140/001-000	URL	Download
-----------------------------------	-----	----------

EPLAN Data Portal 231-140/001-000	URL	Download
-----------------------------------	-----	----------

ZUKEN Portal 231-140/001-000	URL	Download
------------------------------	-----	----------

PCB Design

Symbol and Footprint 231-140/001-000	URL	Download
--------------------------------------	-----	----------

CAX data for your PCB design, consisting of "schematic symbols and PCB footprints", allow easy integration of the WAGO component into your development environment.

Supported formats:

- Accel EDA 14 & 15
- Altium 6 to current version
- Cadence Allegro
- DesignSpark
- Eagle Libraries
- KiCad
- Mentor Graphics BoardStation
- Mentor Graphics Design Architect
- Mentor Graphics Design Expedition 99 and 2000
- OrCAD 9.X PCB and Capture
- PADS PowerPCB 3, 3.5, 4.X, and 5.X
- PADS PowerPCB and PowerLogic 3.0
- PCAD 2000, 2001, 2002, 2004, and 2006

Subject to changes. Please also observe the further product documentation!

- Pulsonix 8.5 or newer
- STL
- 3D STEP
- TARGET 3001!
- View Logic ViewDraw
- Quadcept
- Zuken CadStar 3 and 4
- Zuken CR-5000 and CR-8000

PCB Component Libraries (EDA), PCB CAD Library Ultra Librarian

Environmental Product Compliance

Compliance Search

Environmental Product Compliance 231-140/001-000

[URL](#)

[Download](#)

THT male header; 1.0 x 1.0 mm solder pin; straight; Pin spacing 5 mm; 10-pole; gray

Installation Notes

Coding

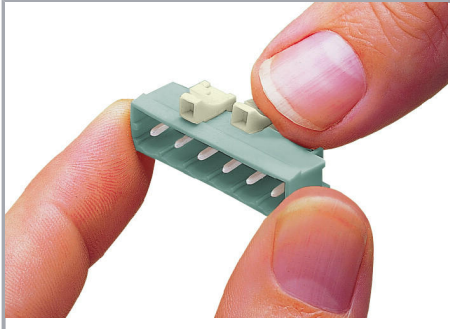

Coding a male header – fitting coding key(s).

Product family

[*MCS* MIDI Classic](#)

[Show all products from the family](#)

Subject to changes. Please also observe the further product documentation!

WAGO Kontakttechnik GmbH & Co. KG

Hansastr. 27

32423 Minden

Phone: +49571 887-0 | Fax: +49571 887-169

Email: info.de@wago.com | Web: www.wago.com

Do you have any questions about our products?

We are always happy to take your call at +49 (571) 887-44222.