

Part Number: KTIR0821DS

*Features

- Compact and thin
- Visible light cut-off type
- High sensitivity
- RoHS Compliant.

*Applications

- Cassette tape recorders, VCRs
- Floppy disk drives
- Various microcosm puterized control equipment

Package Dimensions

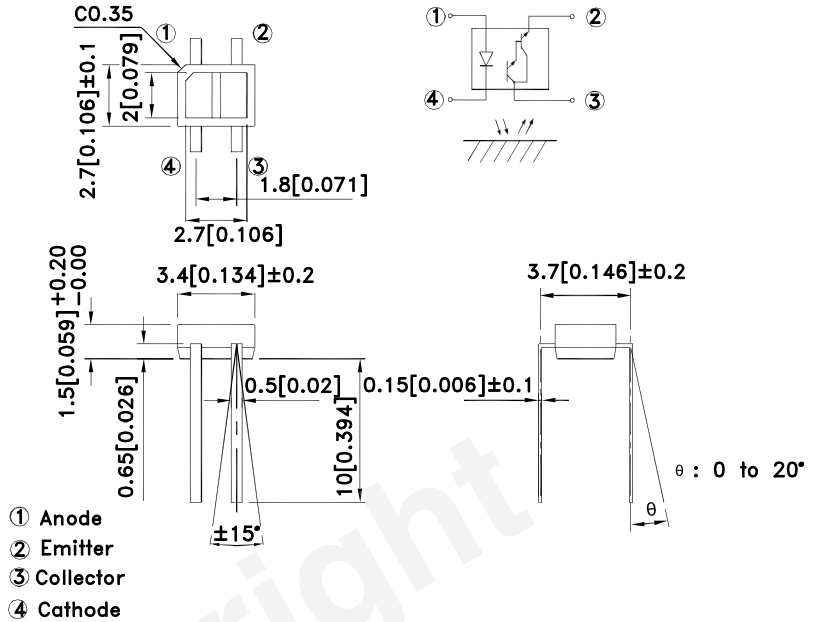

Notes:

1. All dimensions are in millimeters (inches).
2. Tolerance is $\pm 0.25(0.01)$ unless otherwise noted.
3. Lead spacing is measured where the leads emerge from the package.
4. The specifications, characteristics and technical data described in the datasheet are subject to change without prior notice.

*Absolute Maximum Ratings (Ta=25°C)

Parameter		Symbol	Rating	Unit
Input	Forward current	I_F	50	mA
	Reverse voltage	V_R	6	V
	Power dissipation	P_d	75	mW
	Peak Forward Current (Pulse Width $\leq 100\mu\text{s}$, Duty Cycle = 1%)	I_{FP}	1	A
Output	Collector-emitter voltage	V_{CEO}	35	V
	Emitter-collector voltage	V_{ECO}	6	V
	Collector current	I_C	50	mA
	Collector power dissipation	P_C	75	mW
Operating temperature		T_{opr}	-25~+85	°C
Storage temperature		T_{stg}	-40~+100	°C
soldering temperature (1/16 inch from body for 5 seconds)		T_{sol}	260	°C



Electro-optical Characteristics (Ta=25°C)

Parameter		Symbol	Conditions	Min.	TYP.	Max.	Unit	
Input	Forward Voltage	V_F	$I_F=20\text{mA}$	1.0	1.2	1.5	V	
	Reverse Current	I_R	$V_R=6\text{V}$	-	-	10	μA	
	Peak Wavelength	λ_P	$I_F=20\text{mA}$	-	940	-	nm	
Output	Collector Dark Current	I_{CEO}	$V_{CE}=10\text{V}$ $I_F=0\text{mA}$	-	-	10^{-6}	A	
Transfer characteristics	*1 Collector Current	I_C	$V_{CE}=2\text{V}$ $I_F=4\text{mA}$	-	3	-	mA	
	*2 Leak Current	I_{LEAK}	$V_{CE}=5\text{V}$ $I_F=4\text{mA}$	-	-	5	μA	
	Response time	Rise time	t_r	$V_{CE}=2\text{V}$ $I_C=10\text{mA}$ $R_L=100\Omega, d=1\text{mm}$	-	80	400	μsec
		Fall time	t_f		-	70	400	μsec

*1 The condition and arrangement of the reflective object are shown below

*2 Without reflective object

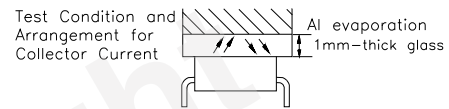

Fig. 1 Forward Current vs. Forward Voltage

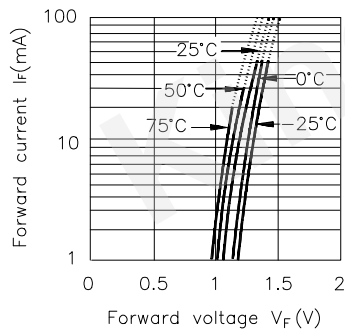

Fig. 3 Collector Current vs. Collector-emitter Voltage

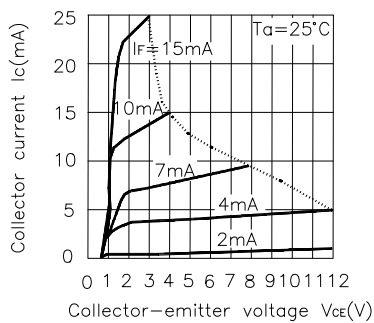

Fig. 2 Collector Current vs. Forward Current

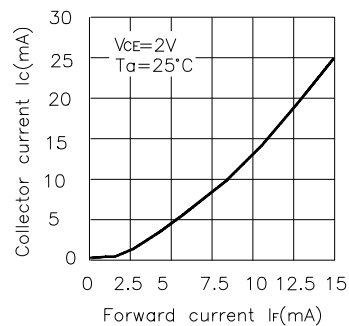

Fig. 4 Relative Collector Current vs. Ambient Temperature

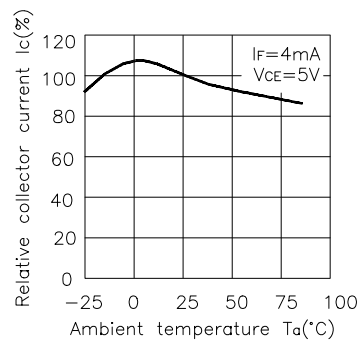
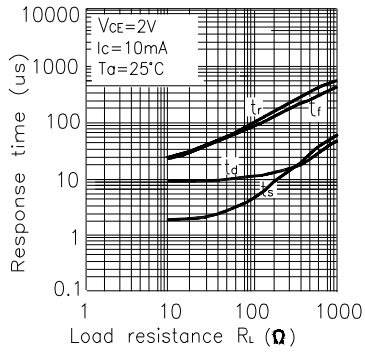

Fig. 5 Response Time vs. Load Resistance



Test Circuit for Response Time

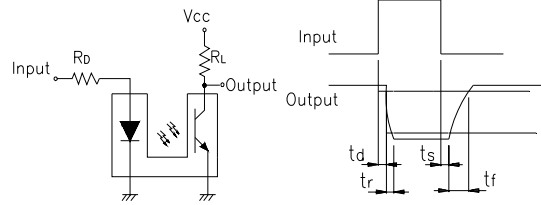

Fig. 6 Collector Dark Current vs. Ambient Temperature

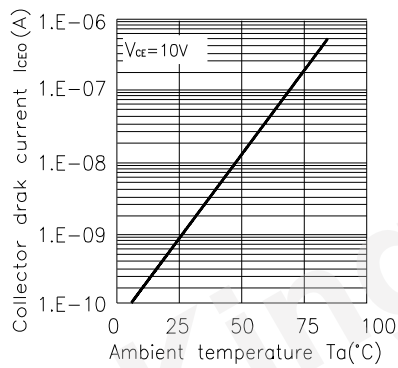

Fig. 7 Relative Collector Current vs. Distance between Sensor and Al Evaporation Glass

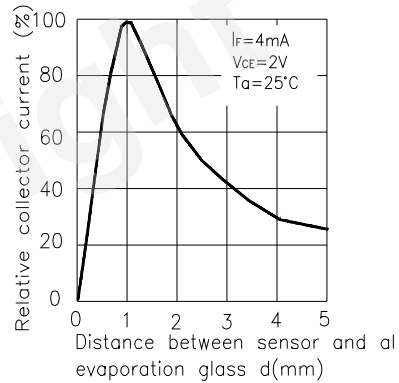

Fig. 8 Relative Collector Current vs. Card Moving Distance (1)

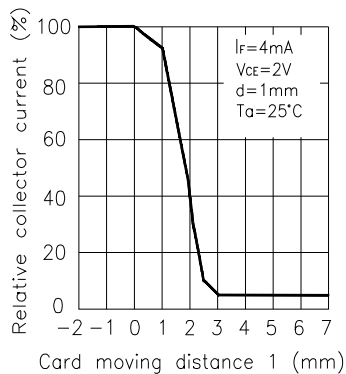
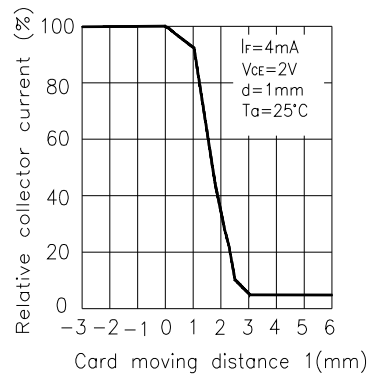
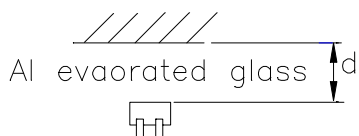

Fig. 9 Relative Collector Current vs. Card Moving Distance (2)



Test Condition for Distance & Detecting Position Characteristics

Correspond to Fig. 7



Correspond to Fig. 8

Test condition

$I_F = 4\text{mA}$
 $V_{CE} = 2\text{V}$
 $d = 1\text{mm}$

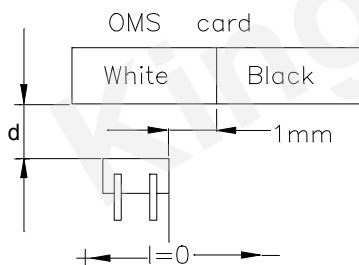

Correspond to Fig. 9

Test condition

$I_F = 4\text{mA}$
 $V_{CE} = 2\text{V}$
 $d = 1\text{mm}$

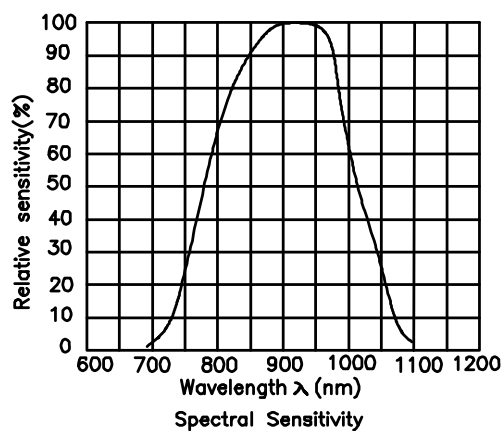
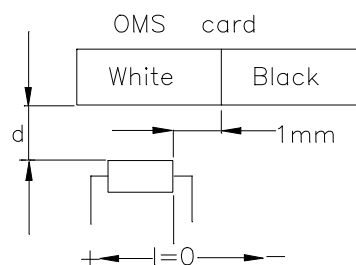

PACKING & LABEL SPECIFICATIONS

KTIR0821DS

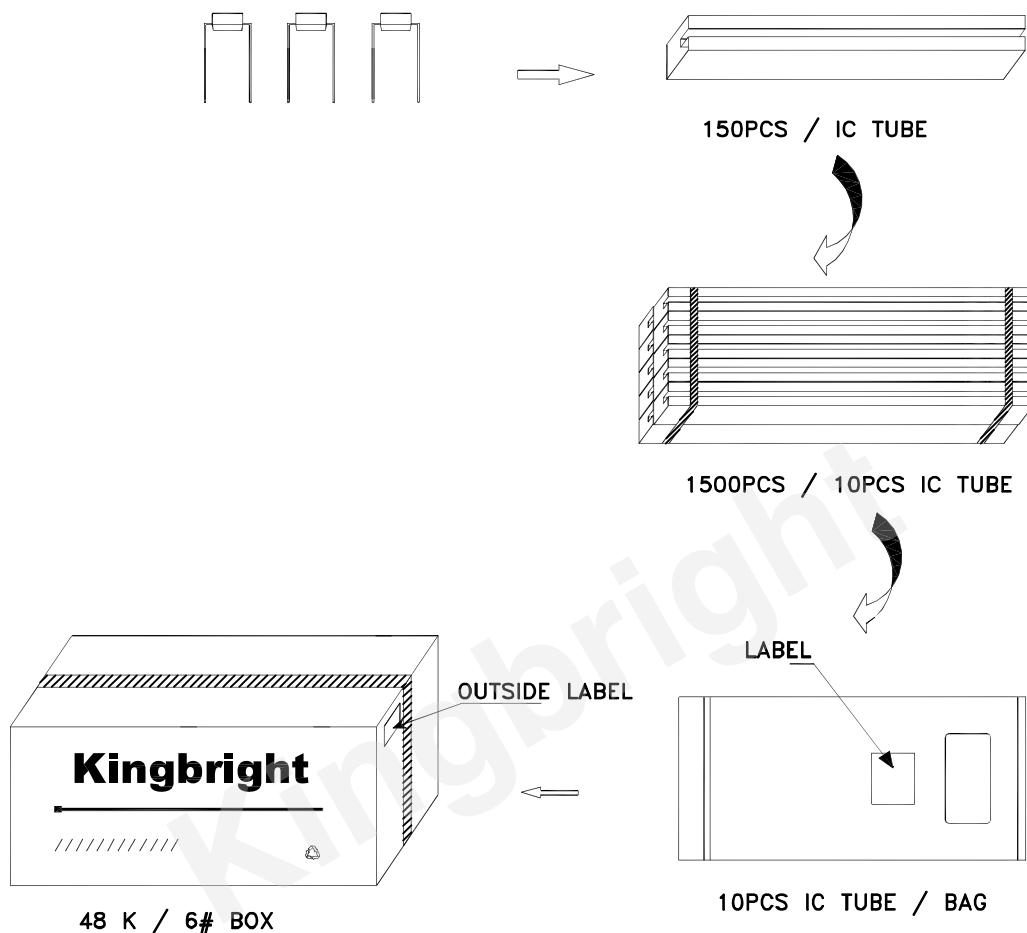

<h1>Kingbright</h1>		
P/NO: KTIR0821DS		
QTY: 1500 pcs	Q.C.	Q C XX XX XXXX PASSED
S/N: XXXX		
CODE: XXX		
LOT NO:		
XXXXXXXXXXXXXXXXXXXX		
RoHS Compliant		

Detailed application notes are listed on our website.
http://www.kingbright.com/application_notes