

# Specification for Approval

Product Name: Constant Voltage LED Driver  
Product Model: LSV-100B012  
Product Code: MS000147-V0  
Rev. A.1  
Sample Date:

CUSTOMER AUTHORIZED SIGNATURE		
Tested By	Checked By	Approved By
(Company seal)Return one copy to MOSO with approved signature and company seal.		

No.1061, Songbai Road, Xili, Nanshan  
Address: District, Shenzhen City, Guangdong Province,  
P.R.China

TEL: 0755-27657000

E-mail: [wcx@mosopower.com](mailto:wcx@mosopower.com)

Post  
Code: 518108

FAX: 0755-27657908

Web [http://www.mosopower.co](http://www.mosopower.com)  
site: m

Prepared By	Checked By	Approved By

# Product Specification

Product Name:            Constant Voltage LED Driver  
Product Model:        LSV-100B012  
Product Code:        MS000147-V0  
Rev.                      A.1

No.1061, Songbai Road, Xili, Nanshan District,  
Address: Shenzhen City, Guangdong Province,  
P.R.China

TEL: 0755-27657000

E-mail: [wcx@mosopower.com](mailto:wcx@mosopower.com)

Post  
Code: 518108

FAX: 0755-27657908

Web <http://www.mosopower.com>  
site: m

Prepared By	Checked By	Approved By

## ECN History

Rev.	Description of Change		Changed Date	Notes
	Before	After		
A.1	Original Release	---	2016-04-29	

Temporary Spec

---

---

## Contents

1	Scope.....	1
2	Input Characteristics.....	1
	2.1 Input Voltage and Frequency.....	1
	2.2 AC Input Current.....	1
	2.3 Inrush Current(Cold Start).....	1
	2.4 Power Factor.....	1
	2.5 Efficiency.....	1
	2.6 Input Current THD.....	1
3	Output Characteristics.....	1
	3.1 Output Power.....	1
	3.2 Output voltage and Current.....	2
	3.3 Output Voltage Ripple.....	2
	3.4 Turn-On Delay Time.....	2
	3.5 Output Voltage Overshoot.....	2
	3.6 Line Regulation.....	2
	3.7 Load Regulation.....	2
4	Protection.....	2
	4.1 Short Circuit Protection.....	2
	4.2 Over Temperature Protection.....	2
	4.3 Over Current Protection.....	2
	4.4 Over Voltage Protection.....	2
5	Safety and Electromagnetic Compatibility.....	3
	5.1 Safety Standards.....	3
	5.2 Electromagnetic Compatibility Standards.....	3
6	Details of Safety Specifications.....	3
	6.1 Dielectric Strength.....	3
	6.2 Grounding Resistance.....	4
	6.3 Leakage Current.....	4
	6.4 Insulation Resistance.....	4
	6.5 Surge Immunity Test.....	4
7	Environmental Specifications.....	4
	7.1 Operated Temperature And Humidity.....	4
	7.2 Storage Temperature And Humidity.....	4
	7.3 Vibration.....	4
	7.4 Degrees of Protection.....	4
8	Reliability.....	4
	8.1 Mean Time Between Failure (MTBF) Qualification (According as MIL-HDBK-217F Standards).....	4

8.2 Life Time Qualification.....	4
9 Temperature vs. Load Curve.....	5
10 Input voltage vs. Load Curve .....	6
11 Efficiency vs. Load Curve .....	6
12 Power Factor vs. Load Curve .....	6
13 Power Factor vs. Input Voltage Curve .....	7
14 Mechanical Outline Drawing.....	7
15 Label.....	7
16 Weight.....	7

Temporary Spec

## 1 Scope

This document defines the electrical, mechanical and environmental specifications of a 320W constant voltage LED driver. The LED driver shall meet the RoHS requirement.

This enclosure of LED driver is:

- With AL Case     
  With Plastic Case     
  Open Frame     
  Others

Note: For all items do not list test temperature in this document, all tests are under  $25^{\circ}\text{C}\pm 10^{\circ}\text{C}$  ambient temperature.

## 2 Input Characteristics

### 2.1 Input Voltage and Frequency

Item	Minimum	Nominal	Maximum
Input Voltage	90Vac	100-277Vac	305Vac
Input Frequency	47Hz	60Hz/50Hz	63Hz

### 2.2 AC Input Current

Under  $25^{\circ}\text{C}\pm 10^{\circ}\text{C}$  ambient temperature, rated input and output range (reference input voltage –Load curve), maximum AC input current value is 1.5A.

### 2.3 Inrush Current(Cold Start)

Under  $25^{\circ}\text{C}\pm 10^{\circ}\text{C}$  ambient temperature, 230Vac input, the peak value of the inrush current is less than 75 A.

### 2.4 Power Factor

2.4.1 Under  $25^{\circ}\text{C}\pm 10^{\circ}\text{C}$  ambient temperature, 230Vac input, 100% load, the typical value of power factor is 0.96; the minimum value is 0.95. (reference Power Factor vs. Load Curve)

### 2.5 Efficiency

2.5.1 Under  $25^{\circ}\text{C}\pm 10^{\circ}\text{C}$  ambient temperature, 230Vac input, 100% load, the typical value of efficiency is 91% the minimum value of efficiency is 90%. (reference Efficiency vs. Load Curve).

### 2.6 Input Current THD

2.6.1 Under  $25^{\circ}\text{C}\pm 10^{\circ}\text{C}$  ambient temperature, 230Vac input, 100% load, the maximum value of input current THD is 15%;

## 3 Output Characteristics

### 3.1 Output Power

Under full input voltage range(reference Input Voltage vs. Load Curve), the maximum value of output power is 100 W.

### 3.2 Output voltage and Current

Item(Unit)	Value	Test Condition(Under 25°C±10°C Ambient Temperature)
Maximum Output Power(W)	100	full input voltage range
Rated Output Voltage(V)	12	full input voltage range
Load Current Range(A)	0~8.33	full input voltage range
Output Voltage Precision	±3 %	full input voltage range, full load range
No Load Voltage(V)	≤12.8	full input voltage range

### 3.3 Output Voltage Ripple

Under 25°C±10°C ambient temperature, 230Vac input, 100% load, the ratio of output voltage ripple peak value and average output voltage is less than 16%.

### 3.4 Turn-On Delay Time

Under 25°C±10°C ambient temperature, rated input voltage, 100% load, turn-on delay time is less than 3000ms.

### 3.5 Output Voltage Overshoot

Under 25°C±10°C ambient temperature, 100% load, turn-on at full input voltage range, the ratio of output voltage overshoot and rated output voltage is less than 10%.

### 3.6 Line Regulation

Under 25°C±10°C ambient temperature, 100% load, change input from 90Vac to 305Vac, line regulation is less than 3 %.

### 3.7 Load Regulation

Under 25°C±10°C ambient temperature, 230Vac input voltage, change load from 50 % to 100 %, load regulation is less than 3 %.

## 4 Protection

### 4.1 Short Circuit Protection

The input power shall decrease when the output rail short, the power supply shall not be damaged.

### 4.2 Over Temperature Protection

When the Tc is over 85°C, the driver shuts off automatically and enters protection status, when the Tc falls below 70°C and AC input reapply, the driver will work normally.

### 4.3 Over Current Protection

The product will enter hiccup status when 1.1-1.5 maximum load current applied to the output, and the product shall be self-recovery when the fault condition is removed.

### 4.4 Over Voltage Protection

When the output voltage is over 1.1-1.4 Rated Load Voltage, the driver shuts off automatically and enters

protection status, the driver will work normally after fault condition removed and AC input reapply.

## 5 Safety and Electromagnetic Compatibility

### 5.1 Safety Standards

Safety Category	Country and region	Standards	Accordant
CCC	China	GB19510.1	
		GB19510.14	
CE	Europe	EN61347-1	
		EN61347-2-13	
CB	CB member	IEC61347-1	
		IEC61347-2-13	
UL	America	UL 8750	
		UL 1310 (Class 2 Power Units)	
		UL 1012	
cUL	Canada	CSA C22.2 No.107.1-01	
		CSA C22.2 No.223-M91 (Power Supplies With Extra-Low-Voltage Class 2 Outputs)	
KC	Korea	K61347-1	
		K61347-2-13	
		K62384	
PSE	Japan	J61347-1	
		J61347-2-13	
SAA	Australia	IEC 61347-2-13	
		AS/NZS 61347.1	

### 5.2 Electromagnetic Compatibility Standards

EMC Certification	Country and region	Standards	Accordant
CCC	China	GB 17743	
		GB 17625.1	
FCC	America	FCC part 15	
CE	Europe	EN 55015	√
		IEC 61000-3-2	
		IEC 61000-3-3	
KC	Korea	IEC 61547	
		K61547	
PSE	Japan	K00015	
		J55015	

## 6 Details of Safety Specifications

### 6.1 Dielectric Strength

6.1.1 input to output : 3750Vac, 60s, current is less than 10mA;

6.1.2 input to FG: 1600Vac, 60s, current is less than 10mA;

6.1.3 output to FG: 1600Vac, 60s, current is less than 10mA.



Note: 25°C±10°C ambient temperature, I/P: L,N Line;O/P: Vo+, Vo-.

## 6.2 Grounding Resistance

Under 25°C±10°C ambient temperature, pass 25A current for 60s, the measured grounding resistance is less than 0.1Ω.

## 6.3 Leakage Current

Leakage Current is defined as the current flowing through the ground wire. Under 25°C±10°C ambient temperature and 230Vac/50Hz input, the leakage current shall be less than 0.75mA.

## 6.4 Insulation Resistance

Under 25°C±10°C ambient temperature and less than 70% relative humidity, apply 500V dc voltage to each port of Input to output, input to GND, output to GND and last 60s, the insulation resistance is at least 100MΩ.

## 6.5 Surge Immunity Test

Under 25°C±10°C ambient temperature, L line to N line is 5000V, L line to FG is 10000V, N line to FG is 10000V.

## 7 Environmental Specifications

### 7.1 Operated Temperature And Humidity

Temperature: -40°C to +50°C, please refer to Temperature vs Load Curve; Relative Humidity: 20% to 95%, non-condensing.

### 7.2 Storage Temperature And Humidity

Temperature: -40°C to +85°C; Relative Humidity: 20% to 95%, non-condensing.

### 7.3 Vibration

10 to 500HZ Sweep at constant acceleration of 1.0G (depth: 3.5mm ) for 1 Hour for each of the perpendicular axes X, Y, Z.

### 7.4 Degrees of Protection

IP67

## 8 Reliability

### 8.1 Mean Time Between Failure (MTBF) Qualification (According as MIL-HDBK-217F Standards)

Mean time between failure is at least 212, 000 hours under 25°C ambient temperature, 115Vac input, and 80% load.

### 8.2 Life Time Qualification

The life time is at least 50, 000 hours, under 60°C case temperature, 230Vac input, and 100% load(reference Life vs.TC curve).

Life vs. Tc

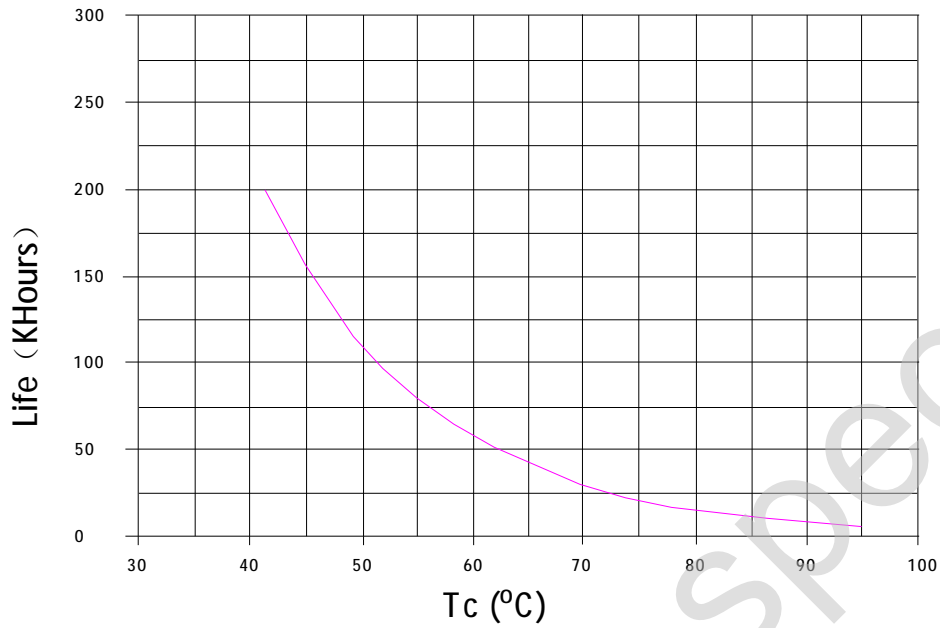

## 9 Temperature vs. Load Curve

Temperature vs. Load Curve

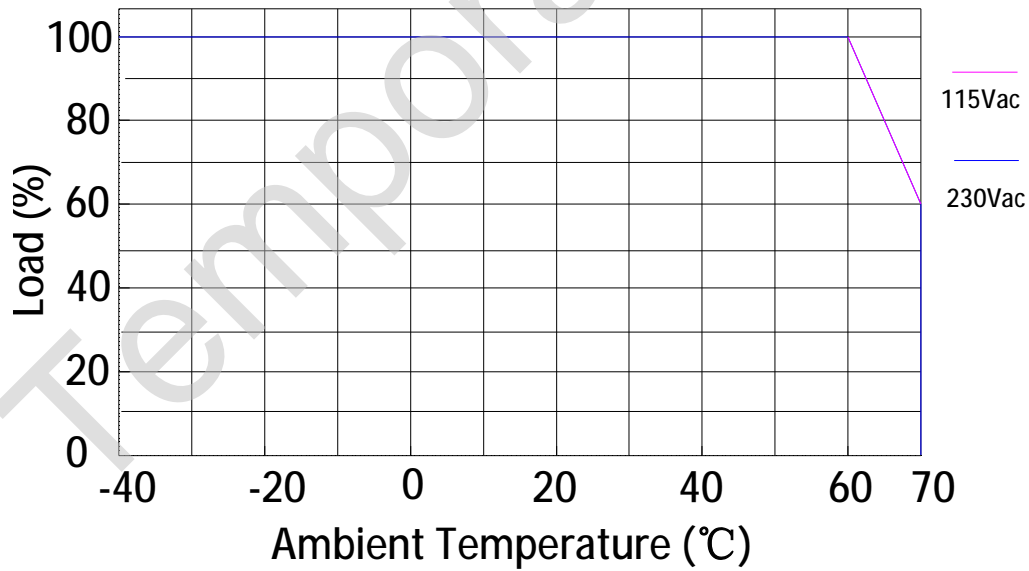

10 Input voltage vs. Load Curve

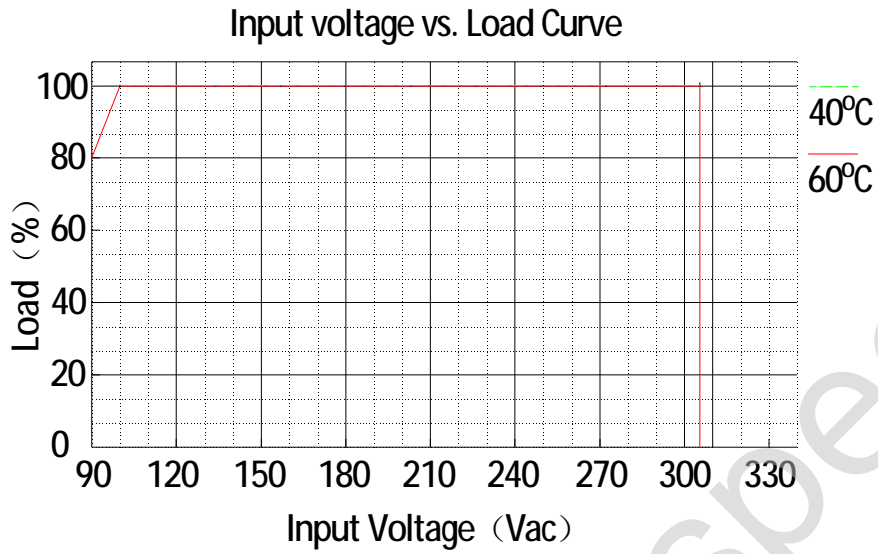

11 Efficiency vs. Load Curve

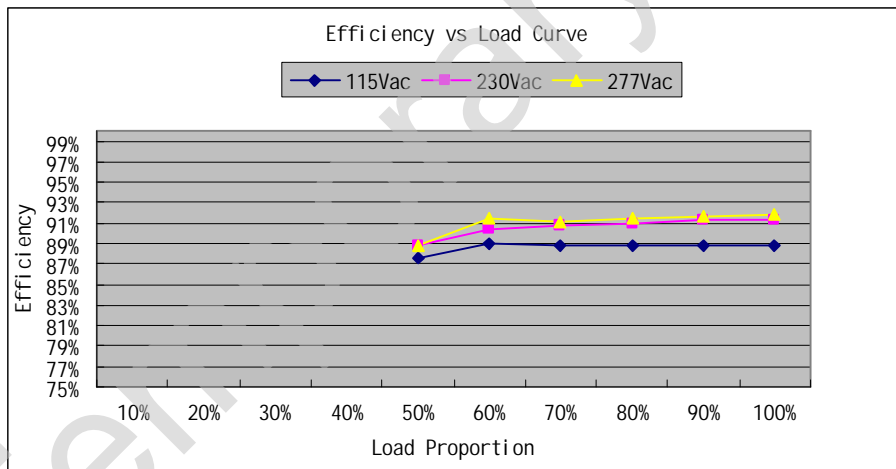

12 Power Factor vs. Load Curve

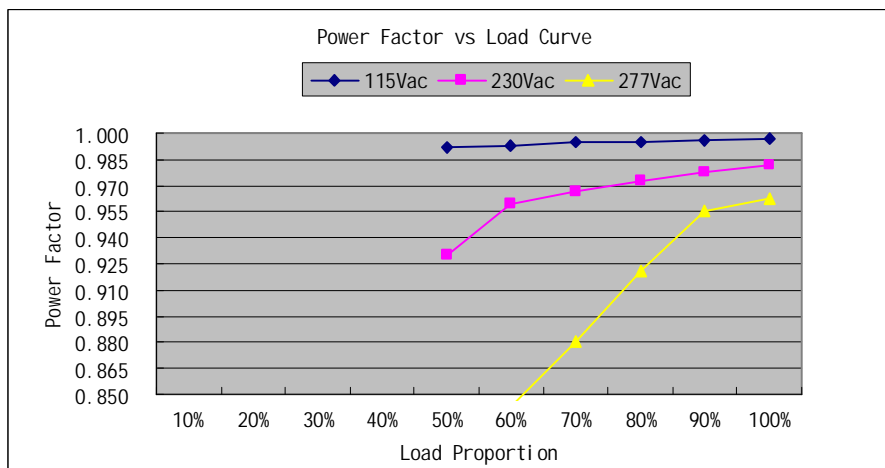

13 Power Factor vs. Input Voltage Curve

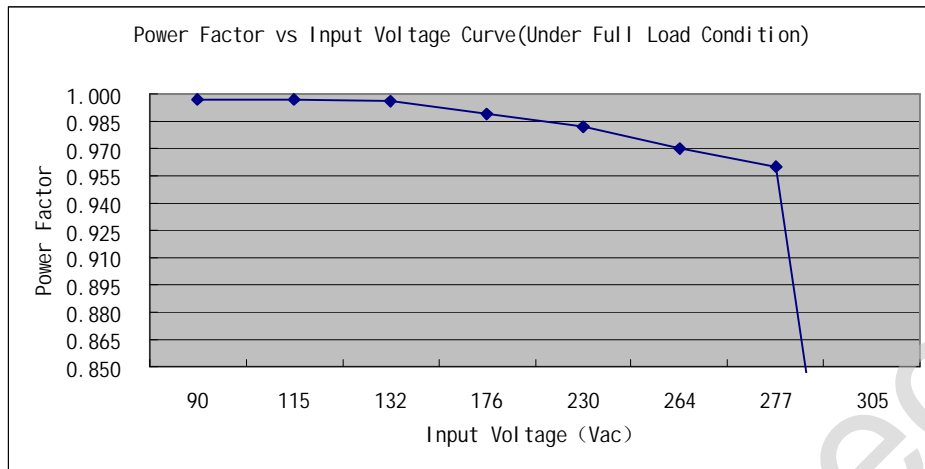

14 Mechanical Outline Drawing

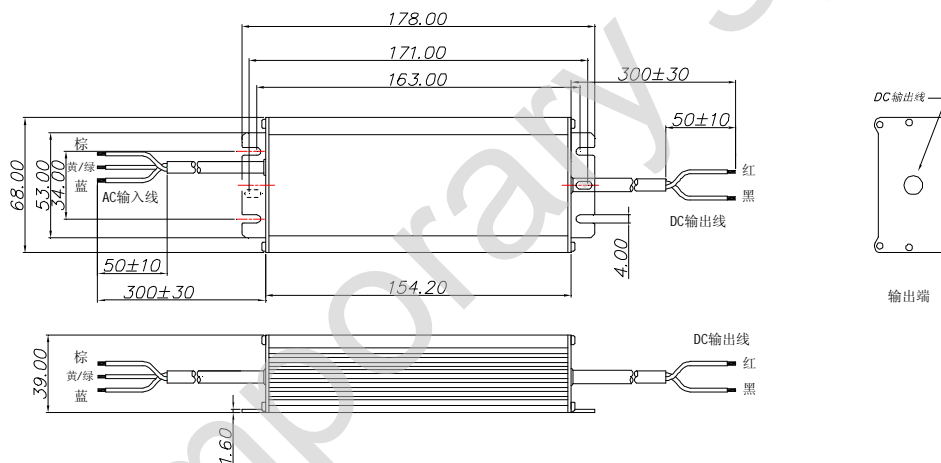

Wire	Specification
AC Input	CCC+VDE 3x1.0mm <sup>2</sup>
DC Output	UL 16#/2C

15 Label



16 Weight

775±50g