

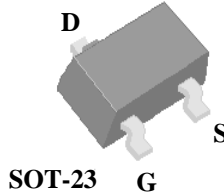

- ▼ Capable of 2.5V Gate Drive
- ▼ Lower On-resistance
- ▼ Surface Mount Package
- ▼ RoHS Compliant

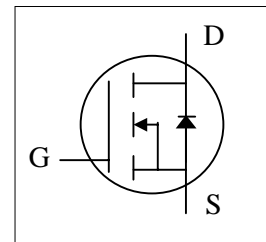

BV_{DSS}	20V
$R_{DS(ON)}$	35m Ω
I_D	5.3A



Description

AP2306 series are from Advanced Power innovated design and silicon process technology to achieve the lowest possible on-resistance and fast switching performance. It provides the designer with an extreme efficient device for use in a wide range of power applications.

The special design SOT-23 package with good thermal performance is widely preferred for all commercial-industrial surface mount applications using infrared reflow technique and suited for voltage conversion or switch applications.

Absolute Maximum Ratings @ $T_J=25^\circ\text{C}$ (unless otherwise specified)

Symbol	Parameter	Rating	Units
V_{DS}	Drain-Source Voltage	20	V
V_{GS}	Gate-Source Voltage	± 12	V
$I_D @ T_A=25^\circ\text{C}$	Drain Current ³ , $V_{GS} @ 4.5\text{V}$	5.3	A
$I_D @ T_A=70^\circ\text{C}$	Drain Current ³ , $V_{GS} @ 4.5\text{V}$	4.3	A
I_{DM}	Pulsed Drain Current ¹	10	A
$P_D @ T_A=25^\circ\text{C}$	Total Power Dissipation	1.38	W
T_{STG}	Storage Temperature Range	-55 to 150	$^\circ\text{C}$
T_J	Operating Junction Temperature Range	-55 to 150	$^\circ\text{C}$

Thermal Data

Symbol	Parameter	Value	Unit
Rthj-a	Maximum Thermal Resistance, Junction-ambient ³	90	$^\circ\text{C}/\text{W}$



Electrical Characteristics @T_j=25°C(unless otherwise specified)

Symbol	Parameter	Test Conditions	Min.	Typ.	Max.	Units
BV _{DSS}	Drain-Source Breakdown Voltage	V _{GS} =0V, I _D =250uA	20	-	-	V
R _{DS(ON)}	Static Drain-Source On-Resistance ²	V _{GS} =10V, I _D =5.5A	-	-	30	mΩ
		V _{GS} =4.5V, I _D =5.3A	-	-	35	mΩ
		V _{GS} =2.5V, I _D =2.6A	-	-	50	mΩ
V _{GS(th)}	Gate Threshold Voltage	V _{DS} =V _{GS} , I _D =250uA	0.5	-	1.25	V
g _{fs}	Forward Transconductance	V _{DS} =5V, I _D =5.3A	-	13	-	S
I _{DSS}	Drain-Source Leakage Current	V _{DS} =16V, V _{GS} =0V	-	-	10	uA
I _{GSS}	Gate-Source Leakage	V _{GS} = ±12V, V _{DS} =0V	-	-	±100	nA
Q _g	Total Gate Charge ²	I _D =5.3A	-	8.7	-	nC
Q _{gs}	Gate-Source Charge	V _{DS} =10V	-	1.5	-	nC
Q _{gd}	Gate-Drain ("Miller") Charge	V _{GS} =4.5V	-	3.6	-	nC
t _{d(on)}	Turn-on Delay Time ²	V _{DS} =15V	-	6	-	ns
t _r	Rise Time	I _D =1A	-	14	-	ns
t _{d(off)}	Turn-off Delay Time	R _G =2Ω	-	18.4	-	ns
t _f	Fall Time	V _{GS} =10V	-	2.8	-	ns
C _{iss}	Input Capacitance	V _{GS} =0V	-	603	-	pF
C _{oss}	Output Capacitance	V _{DS} =15V	-	144	-	pF
C _{rss}	Reverse Transfer Capacitance	f=1.0MHz	-	111	-	pF
R _g	Gate Resistance	f=1.0MHz	-	1.4	2.8	Ω

Source-Drain Diode

Symbol	Parameter	Test Conditions	Min.	Typ.	Max.	Units
V _{SD}	Forward On Voltage ²	I _S =1.2A, V _{GS} =0V	-	-	1.2	V
t _{rr}	Reverse Recovery Time ²	I _S =5A, V _{GS} =0V,	-	16.8	-	ns
Q _{rr}	Reverse Recovery Charge	dI/dt=100A/μs	-	11	-	nC

Notes:

- 1.Pulse width limited by Max. junction temperature.
- 2.Pulse test
- 3.Surface mounted on 1 in² copper pad of FR4 board, t ≤ 10s ; 270°C/W when mounted on min. copper pad.

THIS PRODUCT IS SENSITIVE TO ELECTROSTATIC DISCHARGE, PLEASE HANDLE WITH CAUTION.

USE OF THIS PRODUCT AS A CRITICAL COMPONENT IN LIFE SUPPORT OR OTHER SIMILAR SYSTEMS IS NOT AUTHORIZED.

APEC DOES NOT ASSUME ANY LIABILITY ARISING OUT OF THE APPLICATION OR USE OF ANY PRODUCT OR CIRCUIT DESCRIBED HEREIN; NEITHER DOES IT CONVEY ANY LICENSE UNDER ITS PATENT RIGHTS, NOR THE RIGHTS OF OTHERS.

APEC RESERVES THE RIGHT TO MAKE CHANGES WITHOUT FURTHER NOTICE TO ANY PRODUCTS HEREIN TO IMPROVE RELIABILITY, FUNCTION OR DESIGN.

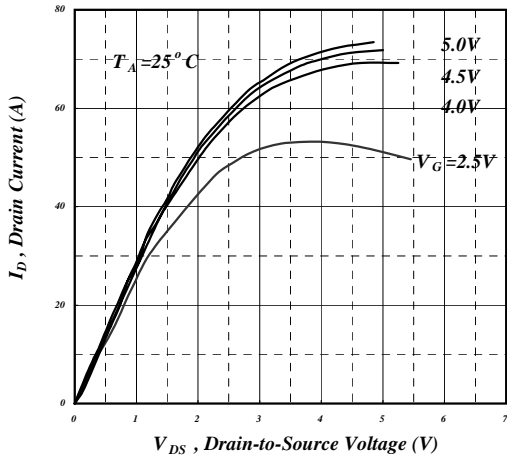

Fig 1. Typical Output Characteristics

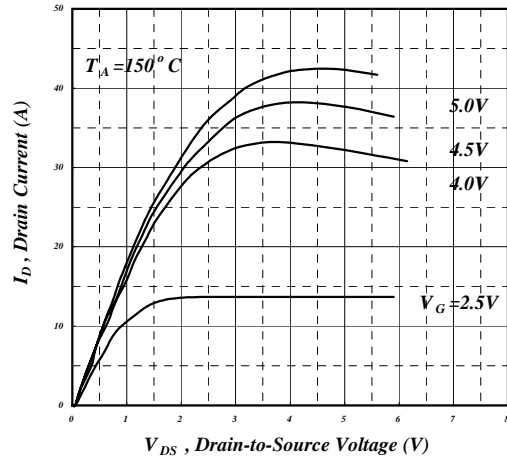

Fig 2. Typical Output Characteristics

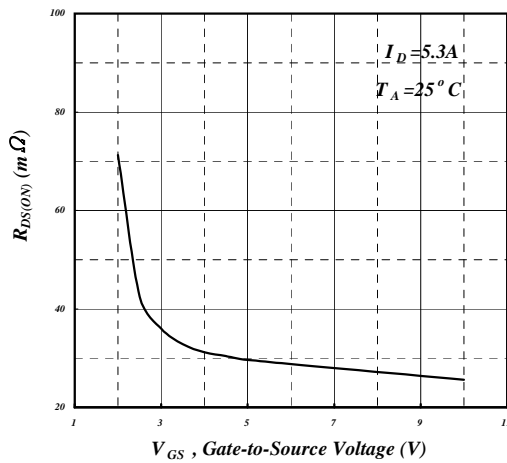

Fig 3. On-Resistance v.s. Gate Voltage

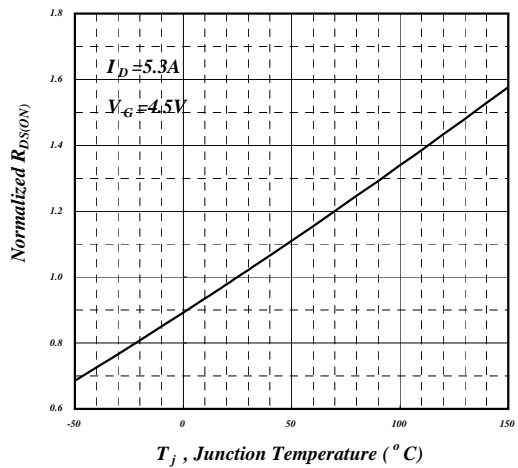

Fig 4. Normalized On-Resistance v.s. Junction Temperature

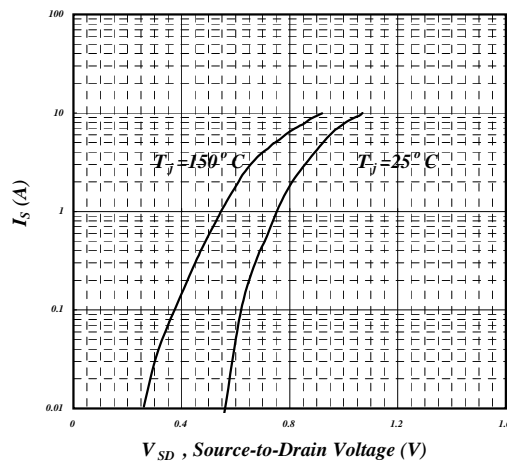

Fig 5. Forward Characteristic of Reverse Diode

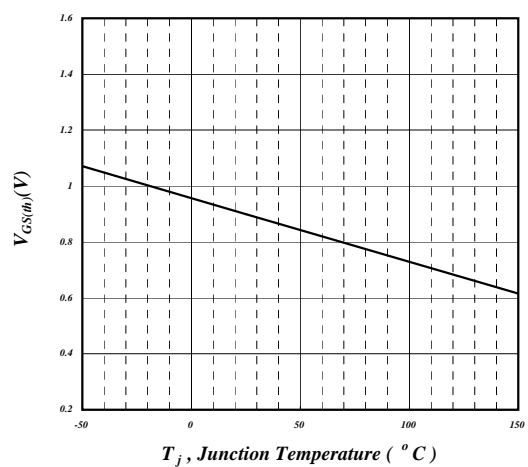

Fig 6. Gate Threshold Voltage v.s. Junction Temperature

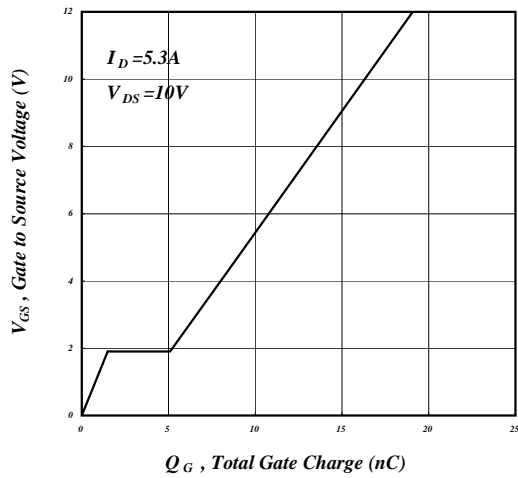

Fig 7. Gate Charge Characteristics

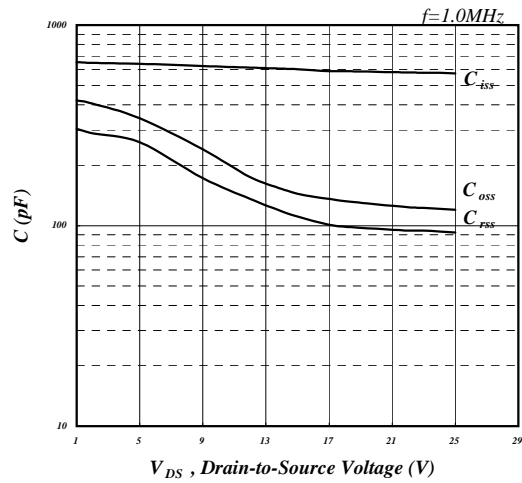

Fig 8. Typical Capacitance Characteristics

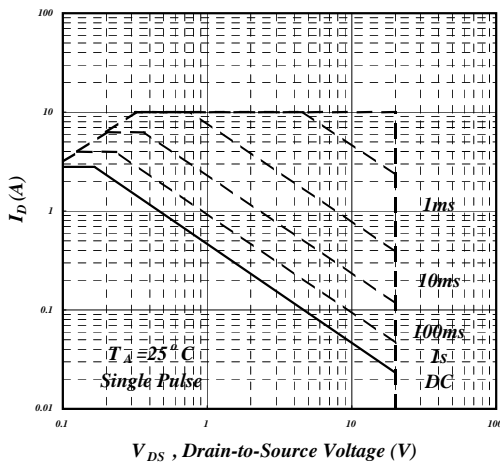

Fig 9. Maximum Safe Operating Area

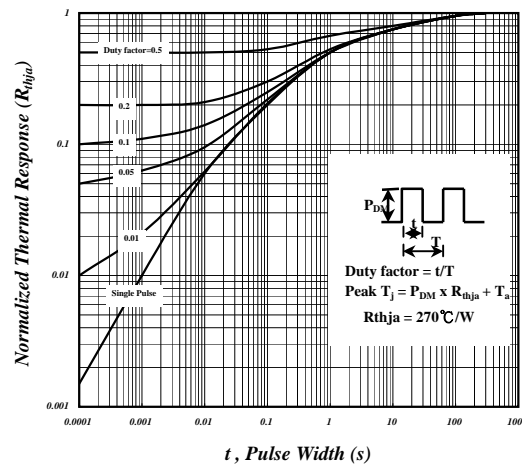

Fig 10. Effective Transient Thermal Impedance

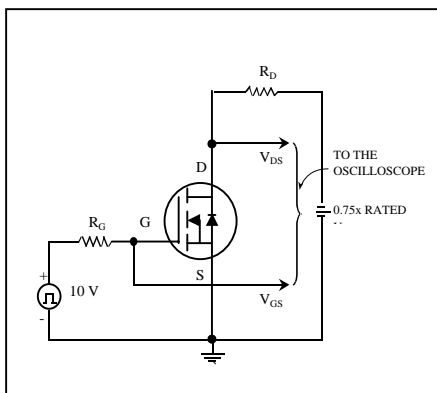

Fig 11. Switching Time Circuit

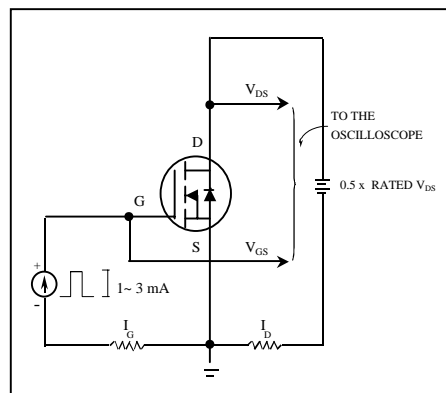
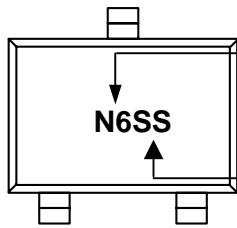

Fig 12. Gate Charge Circuit



MARKING INFORMATION



Part Number : N6

Date Code : SS

SS:2004,2008,2012...

SS:2003,2007,2011...

SS:2002,2006,2010...

SS:2001,2005,2009...