

EVB CONNECTOR

J101 AXK600347YG

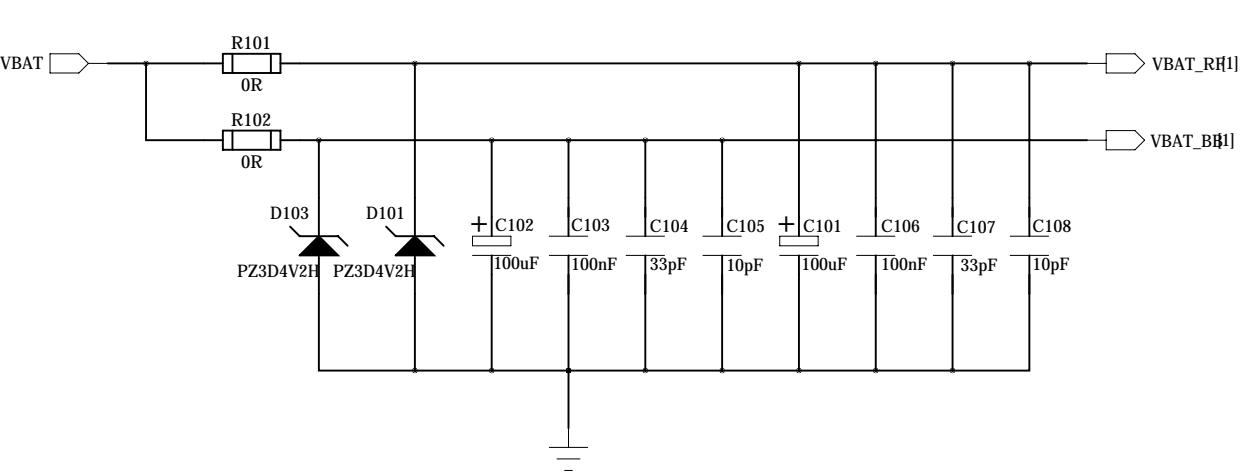

UG96

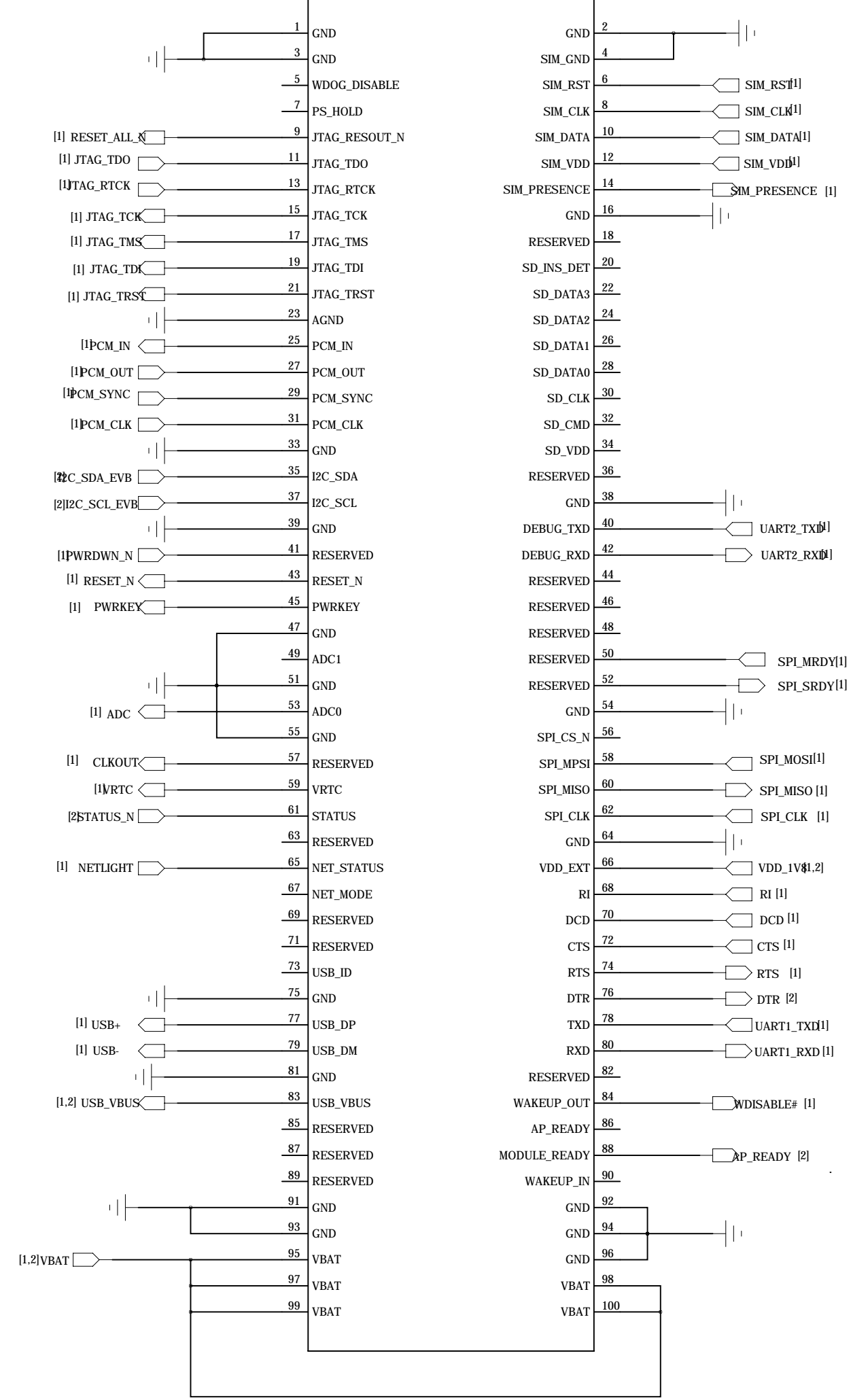
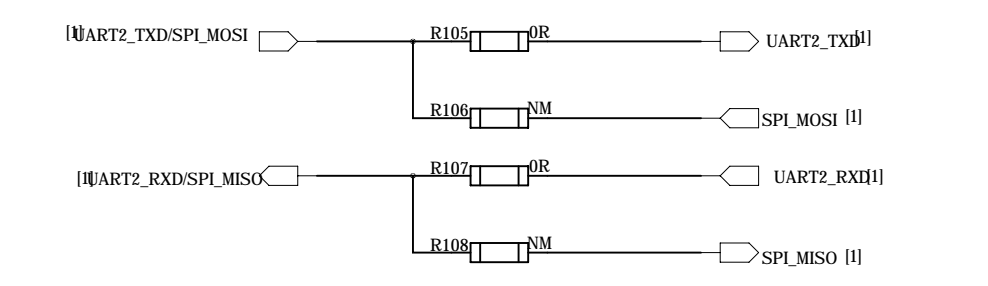
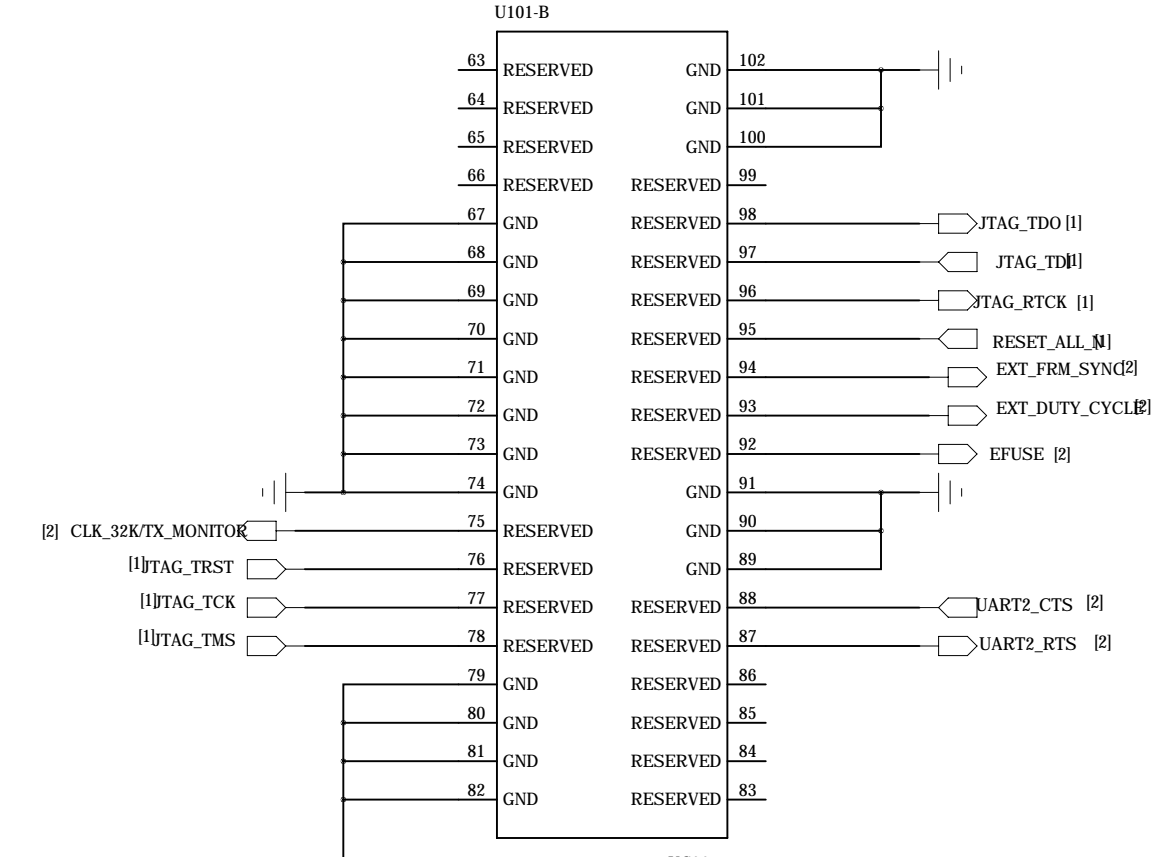
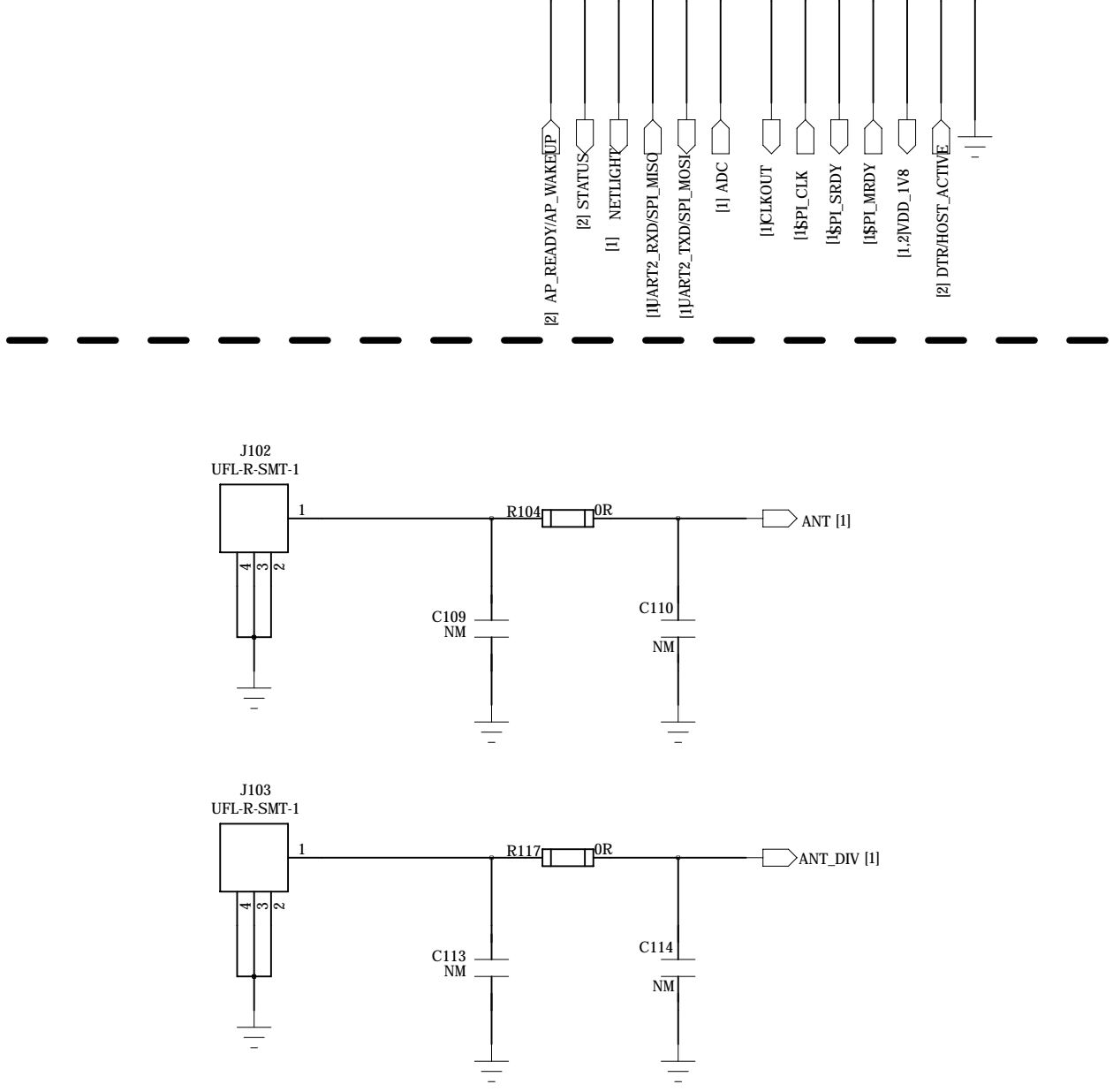
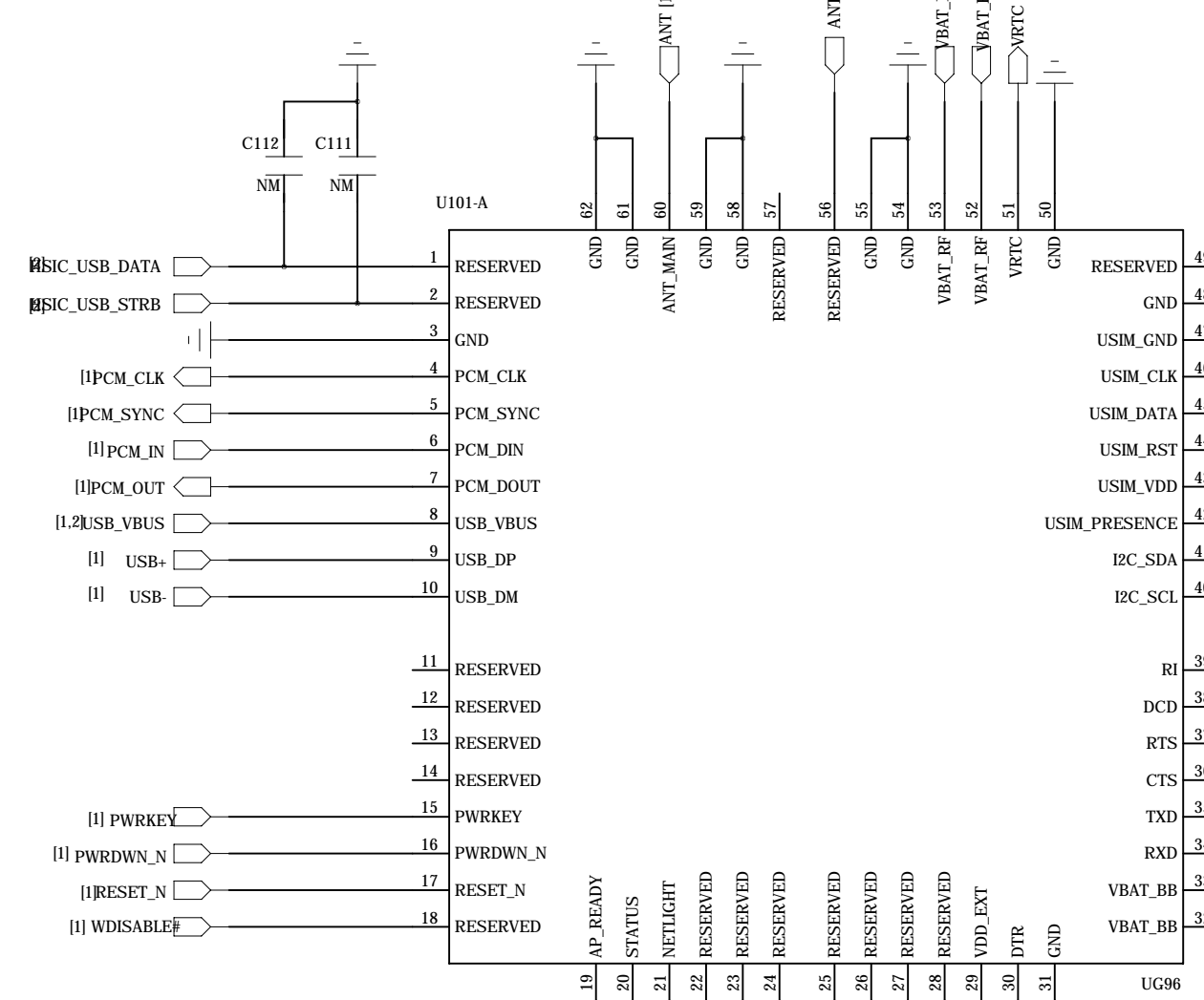

Quectel Wireless Solutions

DRAWN BY <>	PROJECT UG96-TE-A	TITLE B2B Connector
CHECKED BY <NAME HERE>	SIZE A2	VER 1.01
	SHEET 1 of 2	<2014.08>

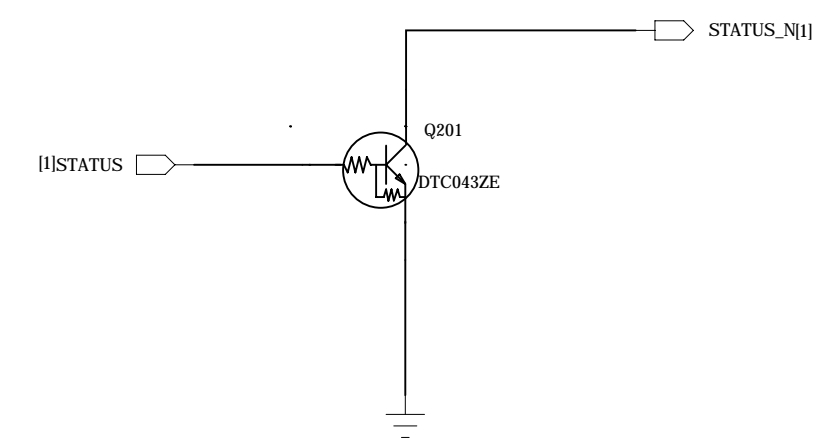
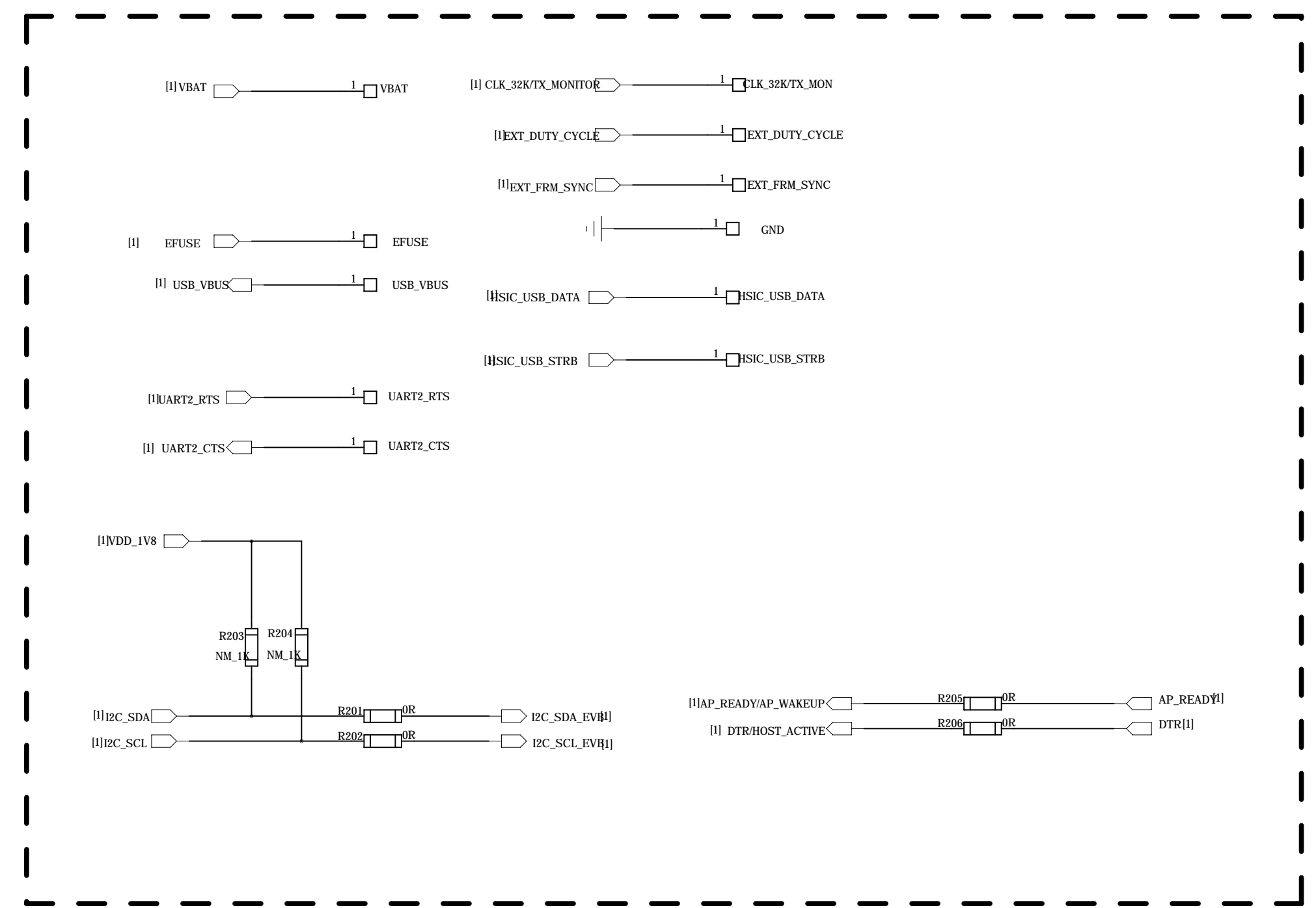

Quectel Technology

DRAWN BY <Yeoman CHEN>	PROJECT UG96-TE-A	TITLE TEST_POINT
CHECKED BY <NAME HERE>	SIZE A2	VER 1.01
SHEET 2 of 2		<2014.08>