

REV.	DESCRIPTION	DRAWN	DATE
2	CORRECTED FORM, REVISED FRAME	FROS	2015/04/14
3	Add new P/N to 5u" plating	FROS	2016/08/17
4	CHANGE P/N	FROS	2016/10/11

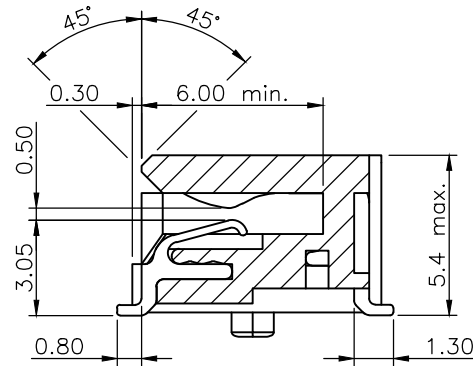
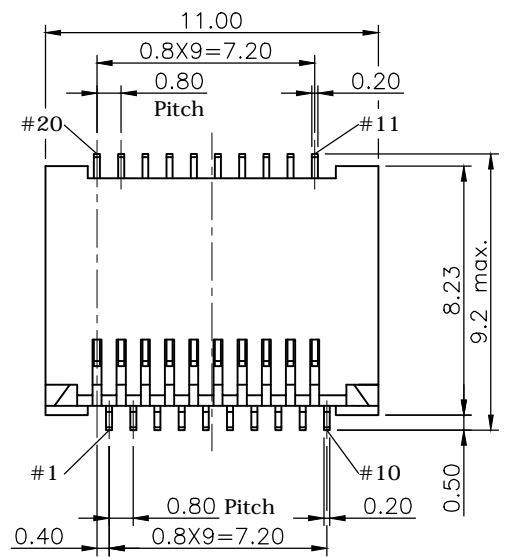

SECTION A-A

SPECIFICATION:

1. ELECTRICAL

- 1.1 Current Rating: 0.5A MAX.
- 1.2 Voltage Rating: 30V AC/DC
- 1.3 Contact Resistance: 20mΩ
- 1.4 Insulation Resistance: 500MΩ
- 1.5 Differential Impedance: 100Ω

2. MECHANICAL

2.1 MATERIAL:

- Housing: LCP UL94V-0, Black
- Contact: Phosphor Bronze, 0.2T
- 2.2 Operating Life : 250 Cycles Min.

3. ENVIRONMENTAL

- 3.1 Operating temperature range: -40°C ~ +85°C
- 3.2 Storage temperature range: -40°C ~ +85°C
- 3.3 IR Temperature: 255°C±5°C (5 to 10 sec)

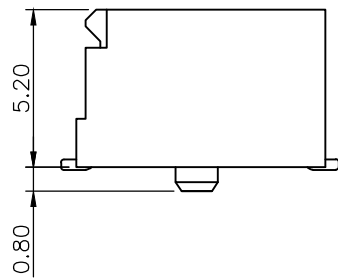
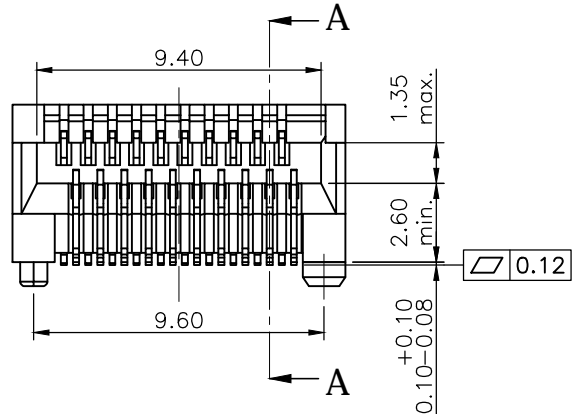

How to order

223A- 00 C 0

Connector 5u" Gold plating

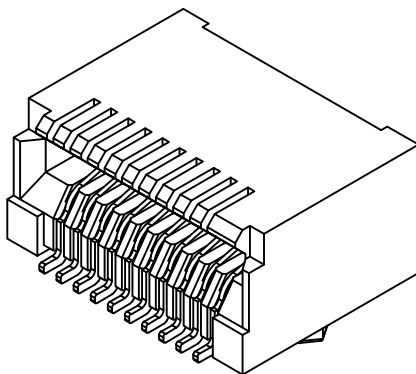
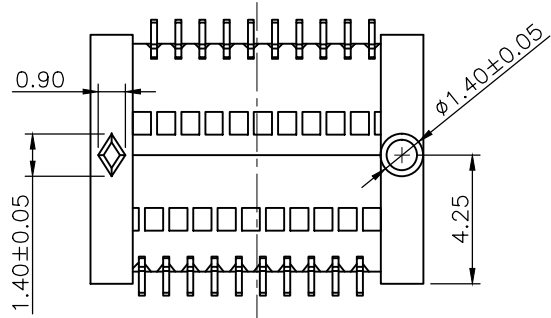

UNLESS OTHERWISE SPECIFIED TOLERANCE					
UNIT:	DECIMAL	LINEAR	ANGLES		
mm	X.	±0.50	±5°	WWW.ATTEND.COM.TW	
	X.X	±0.25	±3°		
	X.XX	±0.12	±1°		
DRAWN	Willis	2009/10/14	DRAWN NAME: 1x1 SFP Connector 20Pin		
CHECKED	Angel	2009/10/14			
APPROVED	Ken	2009/10/14	PRODUCT NO.	223A-00C0	
SCALE	4/1	SHEET	1/2	SIZE	A4
			FILE NAME	223A-00C0_B_4	

REV.	DESCRIPTION	DRAWN	DATE
	SEE SHEET ONE		

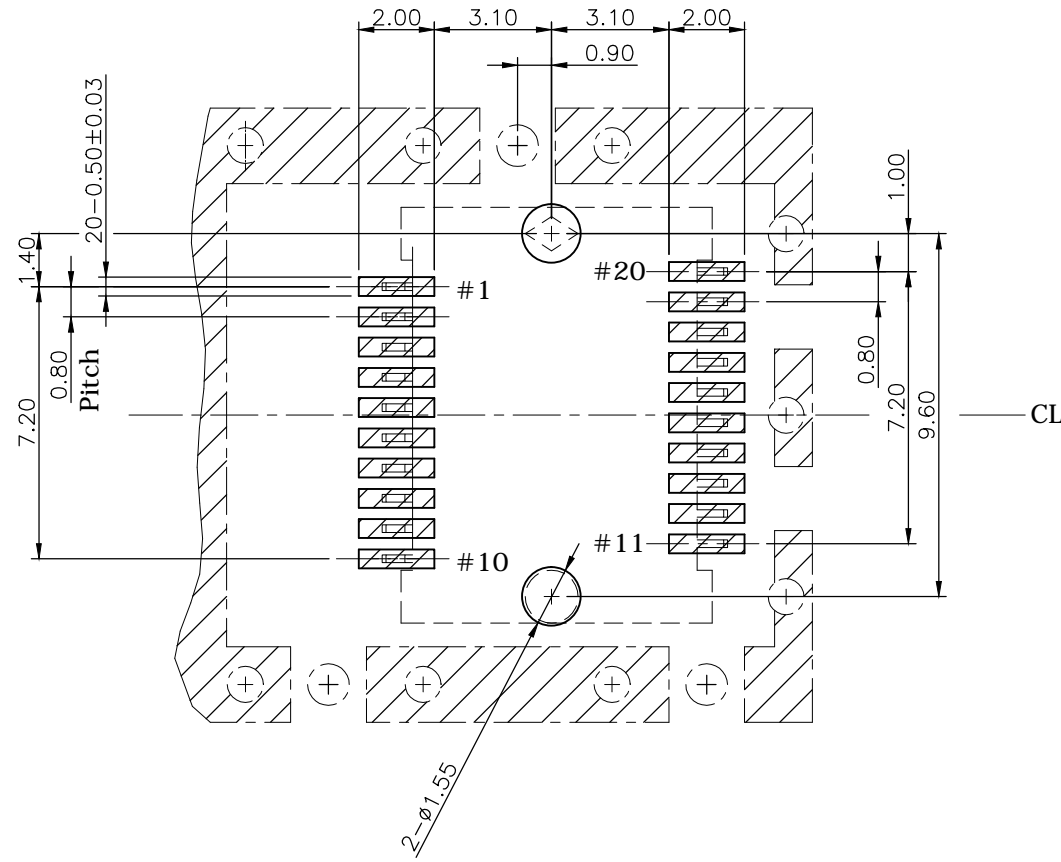

- SFP CONNECTOR
- PAD
- CAGE

RECOMMENDED LAYOUT (TOP VIEW)
GENERAL TOLERANCE: ±0.05mm

UNLESS OTHERWISE SPECIFIED TOLERANCE				
UNIT:	DECIMAL	LINEAR	ANGLES	
mm	X.	±0.50	±5°	
	X.X	±0.25	±3°	
	X.XX	±0.12	±1°	
WWW.ATTEND.COM.TW				
DRAWN	Willis	2009/10/14	DRAWN NAME:	
CHECKED	Angel	2009/10/14	1x1 SFP Connector 20Pin	
APPROVED	Ken	2009/10/14	PRODUCT NO. 223A-00C0	
	SCALE 5/1	SHEET 2/2	SIZE A4	FILE NAME 223A-00C0_B_1