



Features

- Available in E12 values
- Height of 4.5 mm maximum
- Current rating to 9.3 amps
- RoHS compliant*

Applications

- Input/output of DC/DC converters
- Power supplies for:
 - Portable communication equipment
 - Camcorders
 - LCD TVs
 - Car radios

SRR1240 Series - Shielded SMD Power Inductors

Electrical Specifications

Bourns Part No.	Inductance 100 KHz		Q Typ.	Test Freq. (MHz)	SRF Typ. (MHz)	RDC Max. (mΩ)	I rms Max. (A)	I sat Typ. (A)	**K- Factor
	(μH)	Tol. %							
SRR1240-1R0Y	1.0	± 30	10	7.96	85	7.0	9.30	9.20	160
SRR1240-1R5Y	1.5	± 30	16	7.96	80	9.5	9.20	9.00	131
SRR1240-2R4Y	2.4	± 30	10	7.96	54	11.5	8.00	7.80	111
SRR1240-3R3Y	3.3	± 30	14	7.96	43	15.0	6.80	6.50	96
SRR1240-3R9Y	3.9	± 30	14	7.96	39	15.0	6.35	6.20	96
SRR1240-4R7M	4.7	± 20	16	7.96	33	18.0	6.00	5.60	85
SRR1240-5R6M	5.6	± 20	14	7.96	35	20.0	5.40	5.10	76
SRR1240-6R8M	6.8	± 20	14	7.96	34	23.0	5.20	4.70	69
SRR1240-8R2M	8.2	± 20	10	7.96	32	27.0	4.50	4.30	63
SRR1240-100M	10.0	± 20	17	2.52	27	32.0	4.00	4.00	58
SRR1240-120M	12.0	± 20	16	2.52	25	38.0	3.80	3.60	50
SRR1240-150M	15.0	± 20	16	2.52	22	47.0	3.50	3.20	47
SRR1240-180M	18.0	± 20	14	2.52	20	55.0	3.20	3.00	41
SRR1240-220M	22.0	± 20	18	2.52	16	67.5	3.00	2.60	37
SRR1240-270M	27.0	± 20	16	2.52	15.5	85.0	2.55	2.35	34
SRR1240-330M	33.0	± 20	19	2.52	15	97.0	2.30	2.10	31
SRR1240-390M	39.0	± 20	14	2.52	14	120.0	2.15	2.00	28
SRR1240-470M	47.0	± 20	19	2.52	13	135.0	2.00	1.80	26
SRR1240-560M	56.0	± 20	16	2.52	12	170.0	1.80	1.65	24
SRR1240-680M	68.0	± 20	19	2.52	11	200.0	1.50	1.50	22
SRR1240-820M	82.0	± 20	16	2.52	10	250.0	1.35	1.35	20
SRR1240-101M	100.0	± 20	14	0.796	8	300.0	1.25	1.20	18
SRR1240-121K	120.0	± 10	12	0.796	7.8	370.0	1.20	1.15	16
SRR1240-151K	150.0	± 10	12	0.796	7.5	440.0	1.10	1.05	14
SRR1240-181K	180.0	± 10	12	0.796	7.0	550.0	0.98	0.95	13
SRR1240-221K	220.0	± 10	12	0.796	6.6	660.0	0.92	0.90	12
SRR1240-271K	270.0	± 10	10	0.796	6.0	780.0	0.80	0.80	11
SRR1240-331K	330.0	± 10	12	0.796	5.5	950.0	0.75	0.75	10
SRR1240-391K	390.0	± 10	12	0.796	5.0	1150.0	0.70	0.65	9
SRR1240-471K	470.0	± 10	12	0.796	4.5	1350.0	0.62	0.60	8
SRR1240-561K	560.0	± 10	12	0.796	4.0	1500.0	0.55	0.52	7
SRR1240-681K	680.0	± 10	14	0.796	3.8	2000.0	0.50	0.48	7
SRR1240-821K	820.0	± 10	10	0.796	3.5	2400.0	0.45	0.42	6
SRR1240-102K	1000.0	± 10	16	0.252	2.8	3000.0	0.42	0.40	6

**K-Factor: To calculate core flux density, B_p -p (gauss) = $K \times L(\mu H) \times \Delta I$ (peak-to-peak ripple current, A), determine core loss from *Core Loss vs. Flux Density* plot.

Electrical Schematic

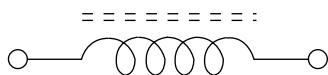

Recommended Layout

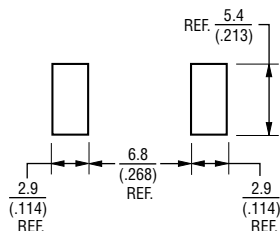

General Specifications

Test Voltage 0.1 V
 Operating Temperature -40 °C to +125 °C
 (Temperature rise included)
 Storage Temperature -40 °C to +125 °C
 Resistance to Soldering Heat 260 °C for 10 sec.

Materials

Core Ferrite DR & RI
 Wire Enameled copper wire 130
 Terminal Cu/Ni/Sn
 Rated Current
 Ind. drop of 25 % typ. at Isat
 Temperature Rise 40 °C max. at rated I rms
 Packaging 800 pcs. per reel

Product Dimensions

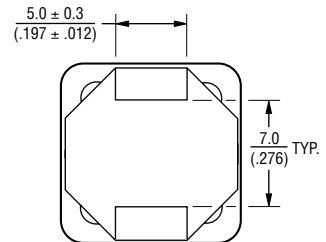
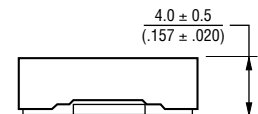
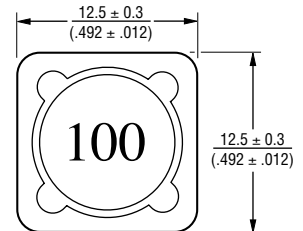

DIMENSIONS: $\frac{MM}{(INCHES)}$

*RoHS Directive 2002/95/EC Jan. 27, 2003 including annex and RoHS Recast 2011/65/EU June 8, 2011.

Specifications are subject to change without notice.

The device characteristics and parameters in this data sheet can and do vary in different applications and actual device performance may vary over time. Users should verify actual device performance in their specific applications.

SRR1240 Series - Shielded SMD Power Inductors

BOURNS®

Core Loss vs. Flux Density

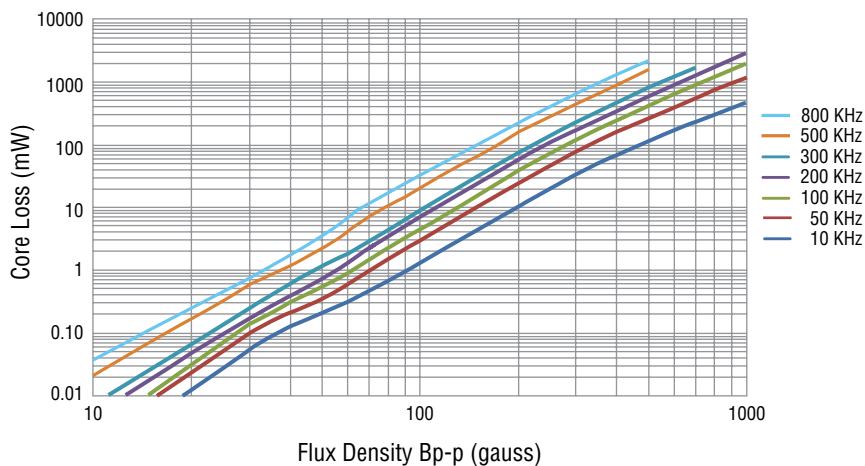

Packaging Specifications

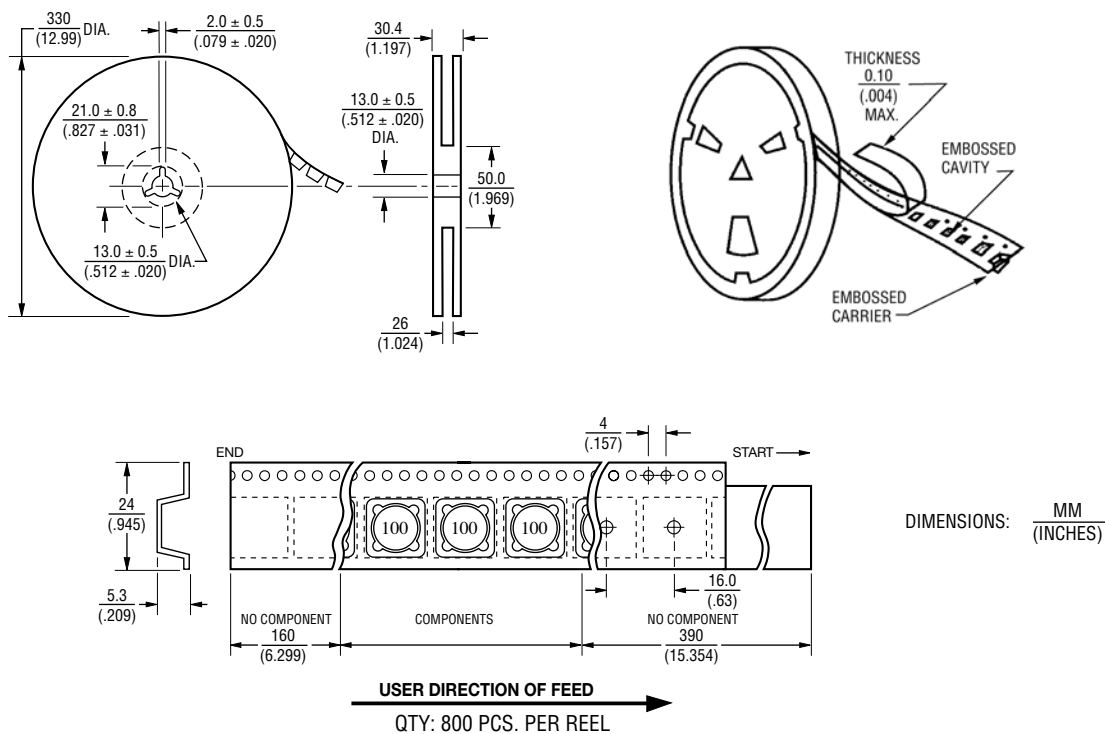

REV. 03/17

Specifications are subject to change without notice. The device characteristics and parameters in this data sheet can and do vary in different applications and actual device performance may vary over time. Users should verify actual device performance in their specific applications.