

KB817

**GENERAL PURPOSE
HIGH ISOLATION VOLTAGE
SINGLE TRANSISTOR TYPE
PHOTOCOUPLER SERIES**

FEATURES

- 1.High isolation voltage between input and output (Viso=5000 Vrms).
- 2.Compact dual-in-line package
KB817:1-channel type
- 3.Recognized by UL and CUL, file NO.E225308.
- 4.Approved by VDE 0884 Teil2(NO:40006364)
(Creepage distance between input and output:7mm or more).
- 5.Rohs compliant.

DESCRIPTION

- 1.The KB817 (1-channel) is optically coupled isolators containing a GaAS light emitting diode and an NPN silicon phototransistor.
- 2.The lead pitch is 2.54mm.
- 3.Solid insulation thickness between emitting diode and output phototransistor: ≥ 0.6 mm.

APPLICATIONS

- 1.Computer terminals.
- 2.Registers,copiers,automatic vending machines.
- 3.System appliances, measuring instruments.
- 4.Programmable logic controller.
- 5.Signal transmission between circuits of different potentials and impedances.

KB817

*PACKAGE DIMENSIONS (UNIT:mm)

DIP Type

TOLERANCE : $\pm 0.5[\pm 0.02]$ UNLESS OTHERWISE NOTED.

KB817

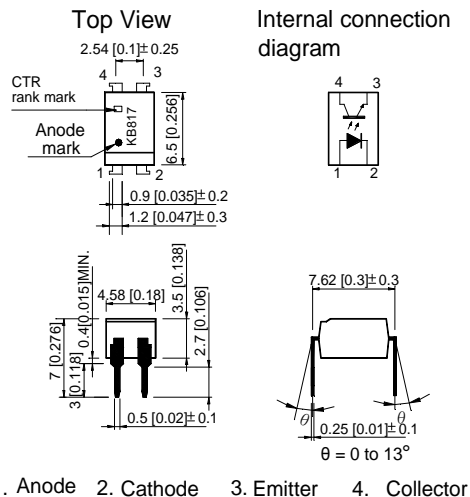

*Absolute Maximum Ratings (Ta=25°C)

| Parameter | | Symbol | Rating | Unit |
|--------------------------|-----------------------------|-----------|----------|------|
| Input | Forward current | I_F | 50 | mA |
| | Reverse voltage | V_R | 6 | V |
| | Power dissipation | P | 70 | mW |
| Output | Collector-emitter voltage | V_{CEO} | 35 | V |
| | Emitter-collector voltage | V_{ECO} | 6 | V |
| | Collector current | I_C | 50 | mA |
| | Collector power dissipation | P_C | 150 | mW |
| Total power dissipation | | P_{tot} | 200 | mW |
| *1 Isolation voltage | | V_{iso} | 5000 | Vrms |
| Operating temperature | | T_{opr} | -30~+100 | °C |
| Storage temperature | | T_{stg} | -55~+125 | °C |
| *2 Soldering temperature | | T_{sol} | 260 | °C |

*1 40 to 60% RH, AC for 1 minute.

*2 For 10 seconds.

*Electro-optical Characteristics

| Parameter | | Symbol | Conditions | Min. | Typ. | Max. | Unit |
|--------------------------|--------------------------------------|---------------|---|---|------|-----------|---------|
| Input | Forward voltage | V_F | $I_F=20mA$ | — | 1.2 | 1.4 | V |
| | Peak forward voltage | V_{FM} | $I_{FM}=0.5A$ | — | — | 3.0 | V |
| | Reverse current | I_R | $V_R=4V$ | — | — | 10 | μA |
| Output | Collector dark current | I_{CEO} | $V_{CE}=20V, I_F=0mA$ | — | — | 10^{-7} | A |
| Transfer characteristics | *1Current transfer ratio | CTR | $I_F=5mA, V_{CE}=5V$ | 50 | — | 600 | % |
| | Collector-emitter saturation voltage | $V_{CE(sat)}$ | $I_F=20mA, I_C=1mA$ | — | 0.1 | 0.2 | V |
| | Cut-off frequency | f_c | $V_{CE}=5V, I_C=2mA$ $R_L=100\Omega, -3dB$ | — | 80 | — | KHz |
| | Response time | Rise time | t_r | $V_{CE}=2V, I_C=2mA$ $R_L=100\Omega$ | — | 4 | 18 |
| Fall time | | t_f | — | | 3 | 18 | μs |

*1 Classification table of current transfer ratio is shown below.

$$CTR = \frac{I_C}{I_F} \times 100\%$$

| Model No. | Rank mark | CTR(%) |
|-----------|----------------------|------------|
| KB817L | L | 50 to 100 |
| KB817A | A | 80 to 160 |
| KB817B | B | 130 to 260 |
| KB817C | C | 200 to 400 |
| KB817D | D | 300 to 600 |
| KB817AB | A or B | 80 to 260 |
| KB817BC | B or C | 130 to 400 |
| KB817CD | C or D | 200 to 600 |
| KB817AC | A,B or C | 80 to 400 |
| KB817BD | B,C or D | 130 to 600 |
| KB817AD | A,B,C or D | 80 to 600 |
| KB817 | L,A,B,C,D or No mark | 50 to 600 |

Fig. 1 Current Transfer Ratio vs. Forward Current

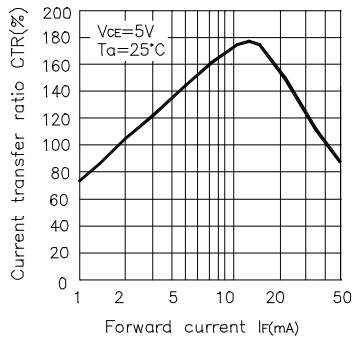

Fig. 2 Forward Current vs. Forward Voltage

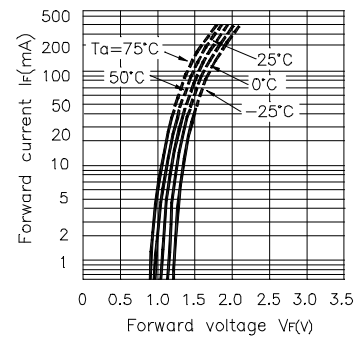

Fig. 3 Collector Current vs. Collector-emitter Voltage

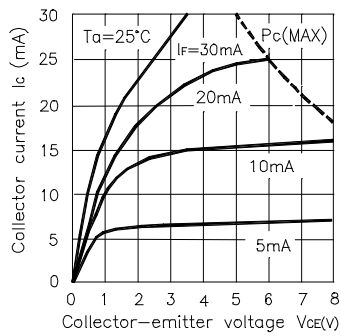

Fig. 4 Relative Current Transfer Ratio vs. Ambient Temperature

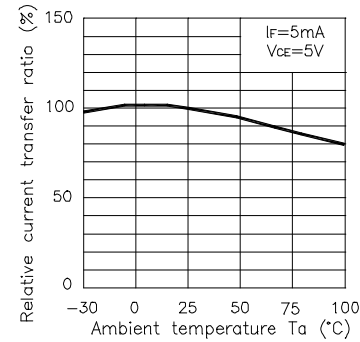

Fig. 5 Collector-emitter Saturation Voltage vs. Ambient Temperature

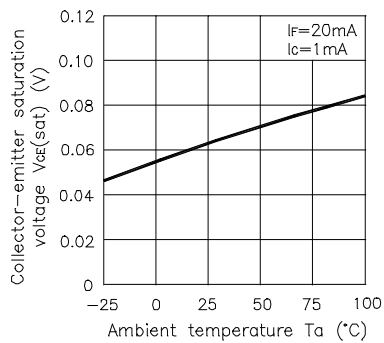

Fig. 6 Collector Dark Current vs. Ambient Temperature

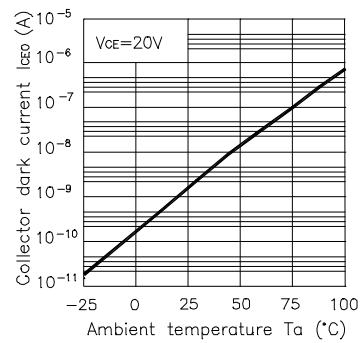

Fig. 7 Forward Current vs. Ambient Temperature

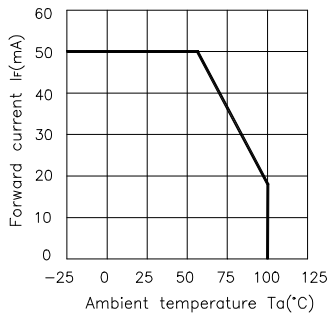

Fig. 8 Collector Power Dissipation vs. Ambient Temperature

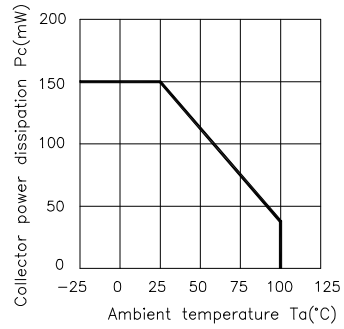
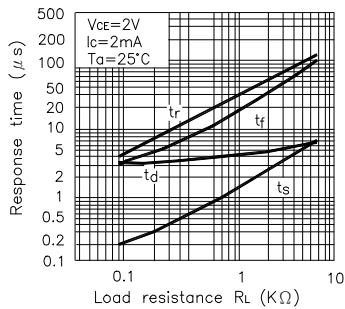

Fig. 9 Response Time vs. Load Resistance



Test Circuit for Response Time

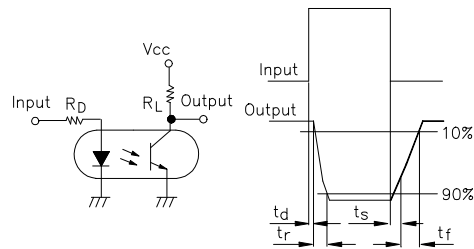
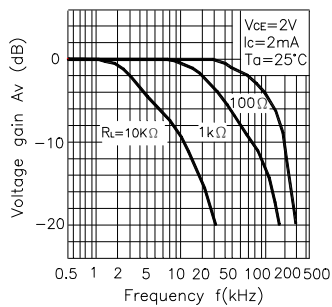

Fig. 10 Frequency Response



Test Circuit for Frequency Response

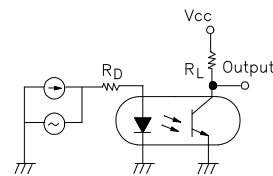
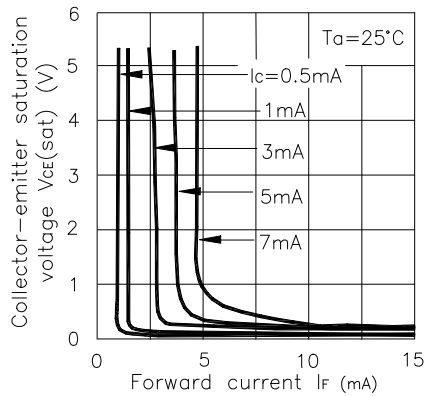

Fig. 11 Collector-emitter Saturation Voltage vs. Forward Current



*NOTES ON HANDLING

1.Recommended soldering conditions (Dip soldering)

(1) Dip soldering

| | |
|-------------|---|
| Temperature | 260 °C or below (molten solder temperature) |
| Time | Less than 10 seconds. |
| Cycle | One cycle allowed to be dipped in solder including plastic mold portion. |
| Flux | Rosin flux containing small amount of chorine (The flux with a maximum chlorine content of 0.2 Wt % is recommended.) |

(2) Cautions

Fluxes
Avoid removing the residual flux with freon-based and chlorine-based cleaning solvent.

2.Cautions regarding noise

Be aware that power is suddenly into the componment any surge current may cause damage happen, even if the voltage is within the absolute maximum ratings.

CAUTION

Within this device there exists GaAs (Gallium Arsenide) material which is a harmful substance if ingested.

GaAs dust and fumes are toxic. Do not break, cut or pulverize the product, or use chemicals to dissolve them.

RESTRICTIONS ON PRODUCT USE

- The information in this document is subject to change without notice. Before using this document, please confirm that this is the latest version. Not all devices / types available in every country.
- We are mention about our product quality stability, semiconductor devices in general can malfunction or fail due to their inherent electrical sensitivity and vulnerability to physical stress. It is the responsibility of the buyer, when utilizing KINGBRIGHT products, to observe standards of safety, and to a avoid situations in which a malfunction or failure of a KINGBRIGHT product could cause loss of human life, bodily injury or damage to property. In developing your designs, please ensure that KINGBRIGHT products are used within specified operating ranges as set forth in the most recent products specifications.

KB817

Dimension of Tube

TOLERANCE : $\pm 0.4[\pm 0.012]$ UNLESS OTHERWISE NOTED.

Unit:mm

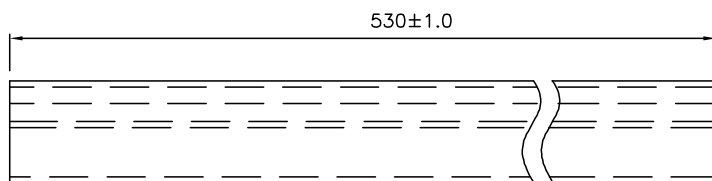
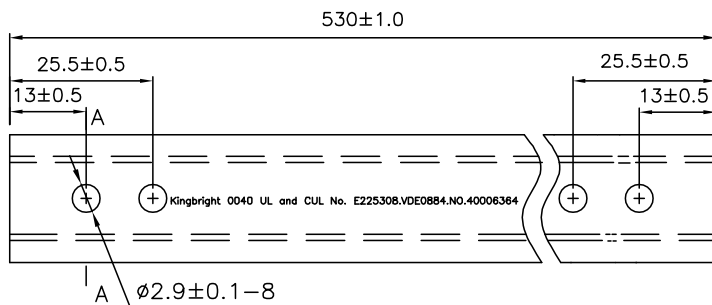

A-A Side view

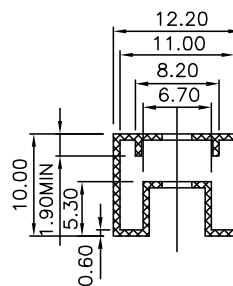

Dimension of Carton

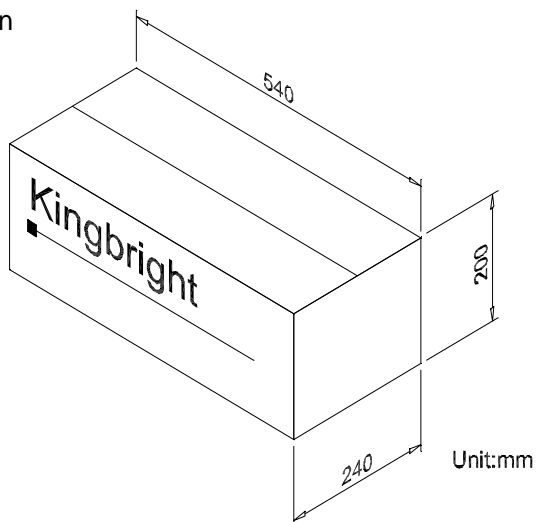

*ORDERING INFORMATION

| Part Number | Package | Package Style |
|-------------|-----------|------------------|
| KB817 | 4-pin DIP | 100pcs/each tube |