

ITEMS	MODIFY	BY	DATE

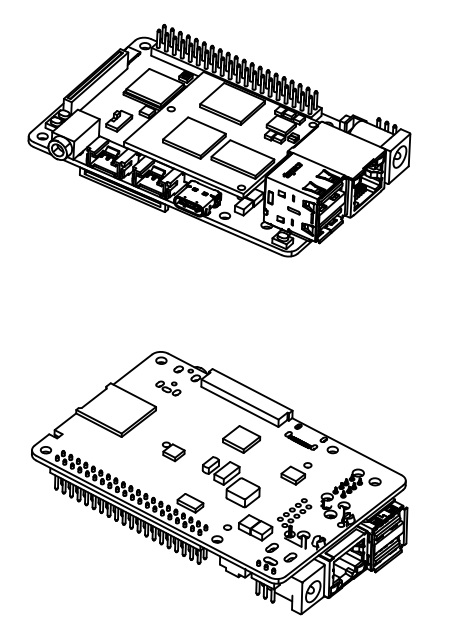
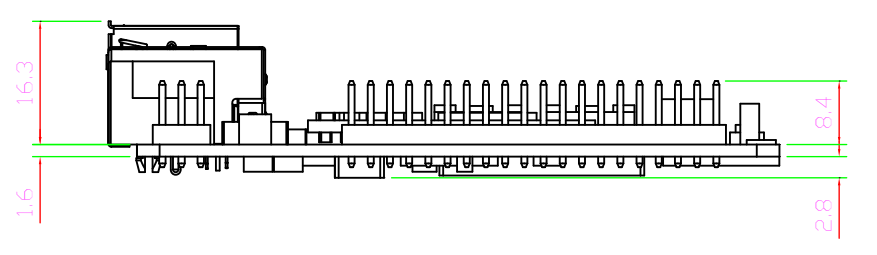
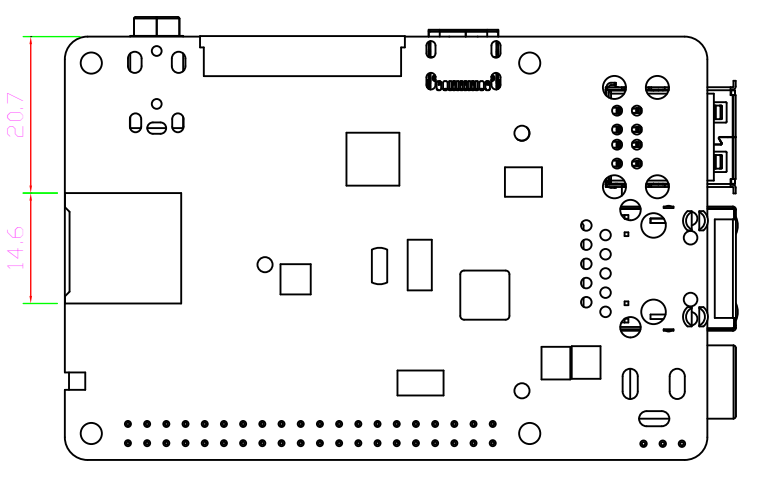
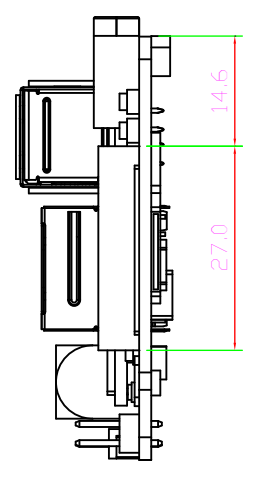
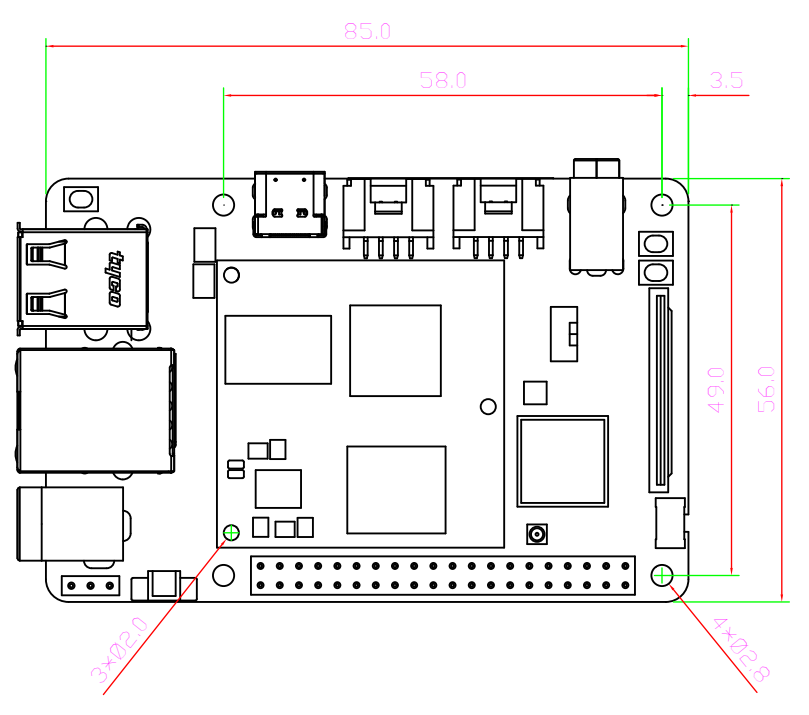
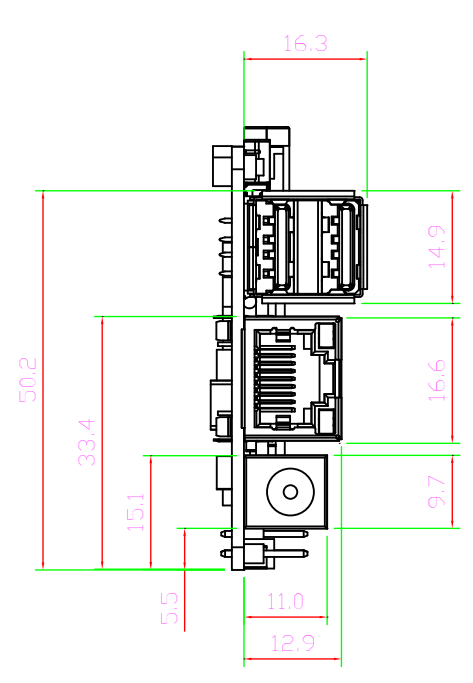
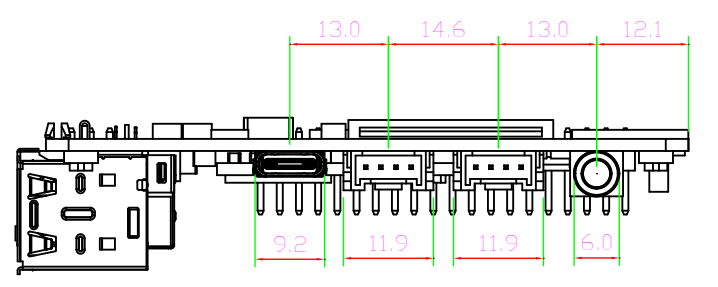

技术说明(Technical Instruction):

1、尺寸仅供参考 (Dimensions are for reference only)

图名 TITLE		版本 VER	A1.0	
图号 DRAWING NO		材质 MATERIAL		
绘图 DWG. BY	校准 CHK. BY	核准 REV	缩水 SHRINKAGE	
			文件 FILE PATH	
			处理 FINISH	
Xu			公差 TOLERANCES UNLESS OTHERWISE SPECIFIED	±0.10 (0.004") ±0.20 (0.008") ±0.30 (0.012") ±0.50 (0.020")
			比例 SCALE	1:1
			单位 UNIT	MM
			视图 3DR	
			WEIGHT: g	SHEET 1 / 1

ALL DIMENSIONS IN MM