

# Features

- Micro size SIP4 package
- 3kVDC/1s basic isolation
- Industry standard pinout
- Optional continuous short circuit protection
- UL94V-0 package material
- Efficiency up to 85%

# Unregulated Converters

# ROM

**1 Watt**  
**SIP4**  
**Micro Size**  
**Single Output**



## Description

The ROM Micro Size DC/DC converter has been designed for isolating or converting DC power rails where board height is at a premium. Although it has a micro-size 7.7mm package, it does not compromise on features and offers a high 3kVDC Isolation , a -40°C to +85°C operating temperature range and optional continuous short circuit protection.

## Selection Guide

Part Number	nom. Input Voltage [VDC]	Output Voltage [VDC]	Output Current [mA]	Efficiency typ. <sup>(1)</sup> [%]	max. Capacitive Load <sup>(2)</sup> [µF]
ROM-xx05S <sup>(3)</sup>	3.3, 5, 12	5	200	70-78	1000
ROM-xx12S <sup>(3)</sup>	3.3, 5, 12	12	83	78-82	470
ROM-xx15S <sup>(3)</sup>	3.3, 5, 12	15	67	80-84	470

### Notes:

Note1: Efficiency is tested at nominal input and full load at +25°C ambient

Note2: Max Cap Load is tested at nominal input and full resistive load and is defined as the capacitive load that will allow start up in under 1s without damage to the converter

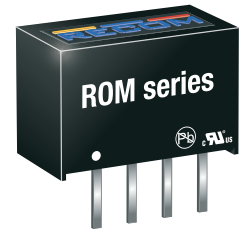

## Model Numbering



### Notes:

Note3: standard part is without continuous short circuit protection add suffix „/P“ for continuous short circuit protection

### Ordering Examples:

ROM-1205S: 12VDC Input Voltage, 5VDC Output Voltage, Single Output

ROM-0515S/P: 5VDC Input Voltage, 15VDC Output Voltage, Single Output with continuous short circuit protection

UL60950-1 certified  
CAN/CSA-C22.2 No 60950-1 certified  
EN60950-1 certified  
IEC60950-1 certified  
EN55032 compliant  
CB report

**Specifications** (measured @ Ta= 25°C, nom. Vin and full load otherwise stated)

**BASIC CHARACTERISTICS**

Parameter	Condition	Min.	Typ.	Max.
Input Voltage Range			±10%	
Minimum Load		0%		
Internal Operating Frequency		50kHz	100kHz	105kHz
Output Ripple and Noise	20MHz BW			100mVp-p

**Efficiency vs. Load**

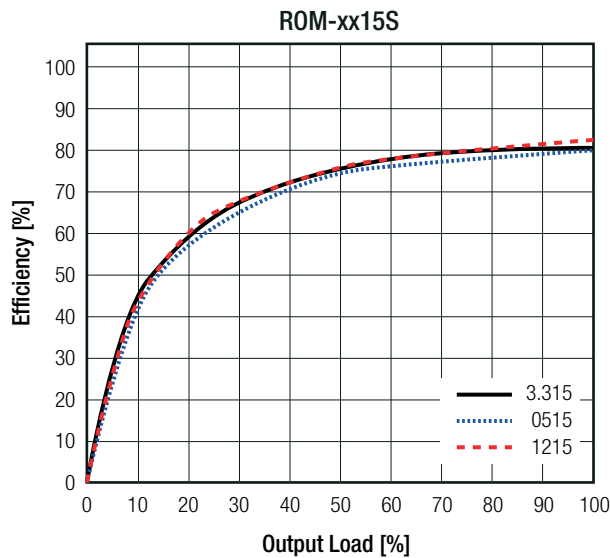
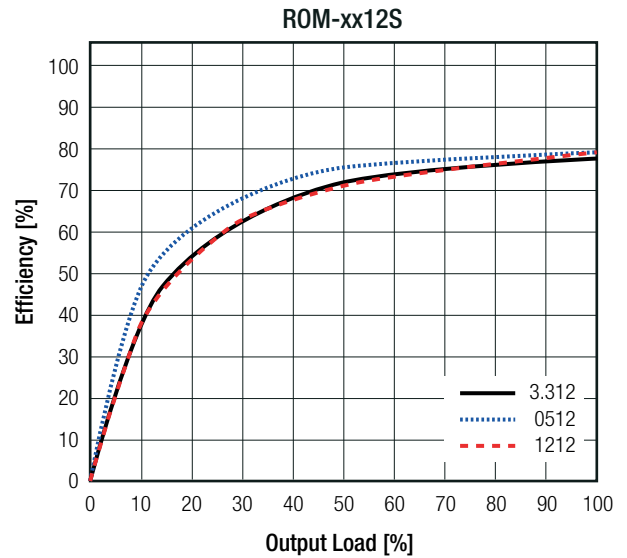
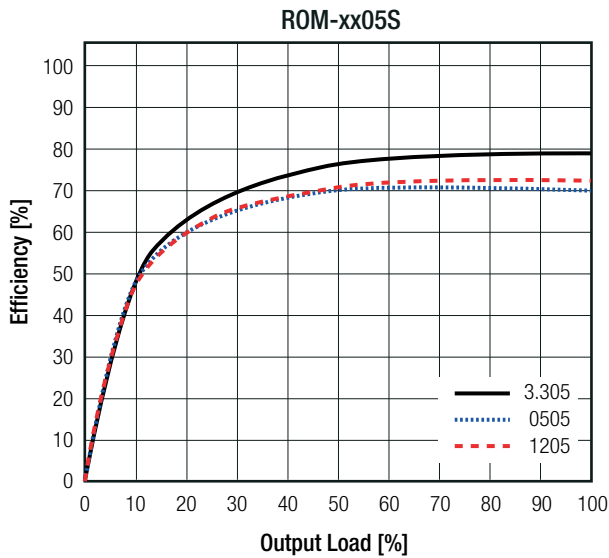

**REGULATIONS**

Parameter	Condition	Value
Output Accuracy		±5.0% max.
Line Regulation	low line to high line	±1.2% of 1.0% Vin typ.

continued on next page

**Specifications** (measured @ Ta= 25°C, nom. Vin and full load otherwise stated)

Parameter	Condition		Value
Load Regulation <sup>(5)</sup>	10% to 100% load	5Vout	15.0% max.
		12, 15Vout	10.0% max.

**Notes:**

Note5: Operation below 10% load will not harm the converter, but specifications may not be met

**Deviation vs. Load**

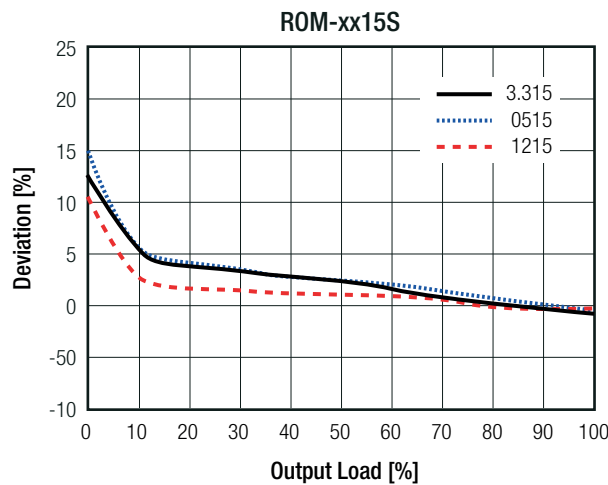
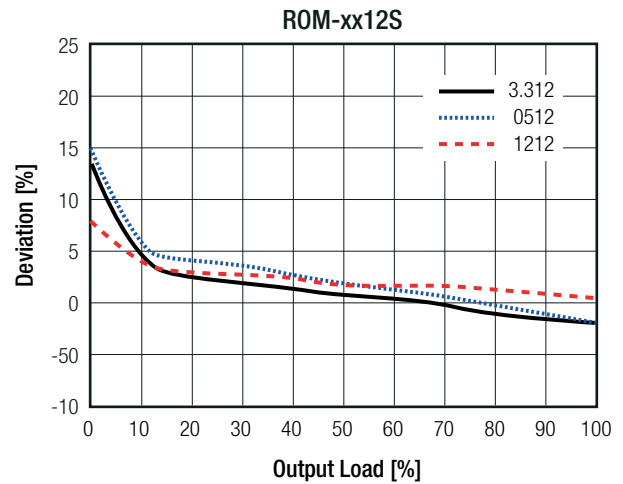
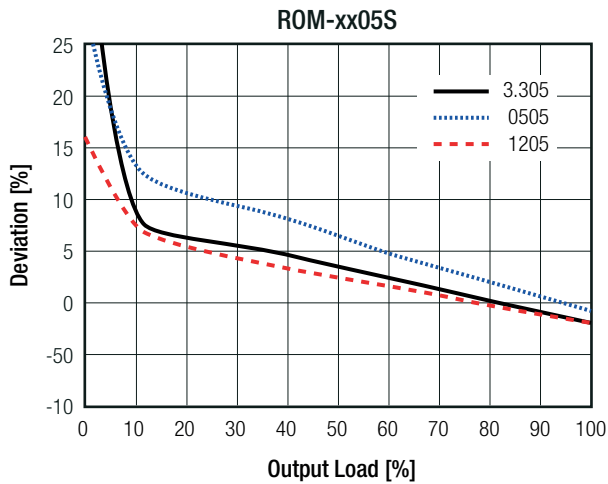

**PROTECTIONS**

Parameter	Type		Value
Short Circuit Protection (SCP)	without suffix		1 second
	with suffix "P"		continuous
Isolation Voltage <sup>(6)</sup>	I/P to O/P	tested for 1 second rated for 1 minute	3kVDC 1.5kVAC/60Hz
Isolation Resistance			15GΩ min.
Isolation Capacitance			20pF min. / 75pF max.
Insulation Grade			basic

**Notes:**

Note6: For repeat Hi-Pot testing, reduce the time and/or the test voltage

Note7: Refer to local wiring regulations if input over-current protection is also required. Recommended fuse: T1A slow blow type

**Specifications** (measured @ Ta= 25°C, nom. Vin and full load otherwise stated)

ENVIRONMENTAL			
Parameter	Condition	Value	
Operating Temperature Range	full load @ free air convection (see graph)	-40°C to +85°C	
Operating Altitude		2000m	
Operating Humidity	non-condensing	95% RH max.	
Pollution Degree		PD2	
MTBF	according to MIL-HDBK-217F, G.B.	+25°C	977 x 10 <sup>3</sup> hours
		+85°C	189 x 10 <sup>3</sup> hours

**Derating Graph**  
(@ free air convection)

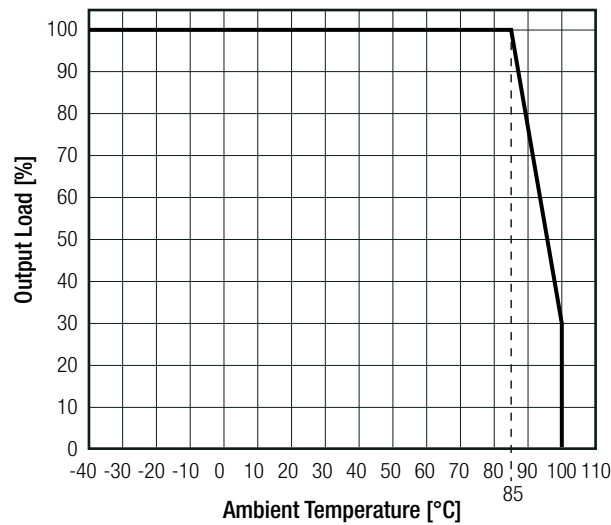

SAFETY AND CERTIFICATIONS		
Certificate Type (Safety)	Report / File Number	Standard
Information Technology Equipment, General Requirements for Safety	E358085-A4-UL	UL60950-1, 2nd Edition:2007 CAN/CSA C22.2 No. 60950-1-03, 2nd Edition:2007
Information Technology Equipment, General Requirements for Safety (CB)	E322406-A4-CB-1	IEC60950-1:2005, 2nd Edition
Information Technology Equipment, General Requirements for Safety	SPCLVD1602031	IEC60950-1:2005, 2nd Edition + A2:2013 EN60950-1:2006 + A2:2013
EAC	RU-AT.49.09571	TP TC 004/2011
RoHS 2+		RoHS-2011/65/EU + AM-2015/863
EMC Compliance	Condition	Standard / Criterion
Electromagnetic compatibility of multimedia equipment - Emission requirements	with external filter (see filter suggestion below)	EN55032, Class B EN55032, Class A

continued on next page

### Specifications (measured @ Ta= 25°C, nom. Vin and full load otherwise stated)

#### EMC Filter Suggestion according to EN55032

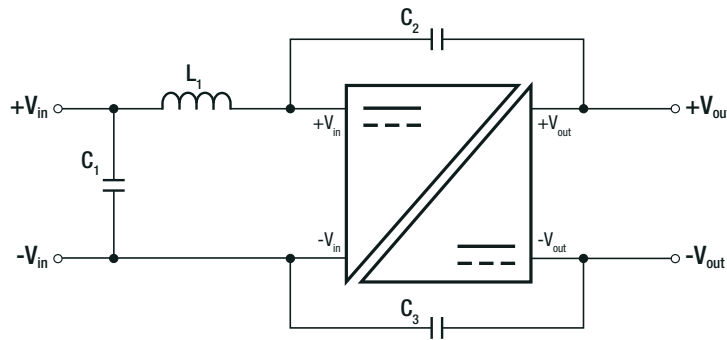

#### Component List Class A

MODEL	C1	L1	C2 (safety)	C3 (safety)
ROM-0505S	10µF 100V MLCC	N/A	N/A	N/A
ROM-1205S				2.2nF
ROM-2405S				2.2nF

#### Component List Class B

MODEL	C1	L1	C2 (safety)	C3 (safety)
ROM-0505S	10µF 100V MLCC	22µH choke RLS-226	1nF	N/A
ROM-1205S				2.2nF
ROM-2405S				2.2nF

#### Notes:

Note8: Filter suggestions are valid for indicated part numbers only. For other part numbers, please contact RECOM tech support for advice

#### DIMENSION AND PHYSICAL CHARACTERISTICS

Parameter	Type	Value
Material	case potting PCB	non-conductive black plastic (UL94 V-0) epoxy, (UL94 V-0) FR4, (UL94 V-0)
Dimension (LxWxH)		11.5 x 6.05 x 7.7mm
Weight		1g typ.

#### Dimension Drawing (mm)

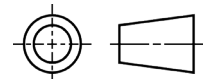
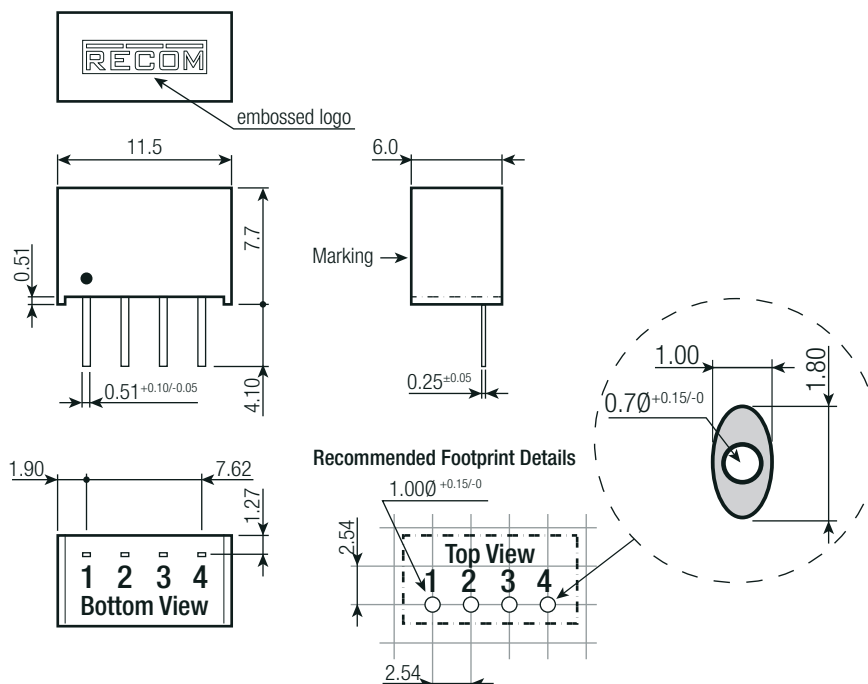

#### Pinning information

Pin #	Single
1	-Vin
2	+Vin
3	-Vout
4	+Vout

Tolerance:  
xx.x= ±0.5mm  
xx.xx= ±0.25mm

**Specifications** (measured @ Ta= 25°C, nom. Vin and full load otherwise stated)

PACKAGING INFORMATION		
Parameter	Type	Value
Packaging Dimension (LxWxH)	tube	520.0 x 16.0 x 9.0mm
Packaging Quantity	tube	42pcs
Storage Temperature Range		-55°C to +125°C
Storage Humidity	non-condensing	95% RH max.

The product information and specifications may be subject to changes even without prior written notice. The product has been designed for various applications; its suitability lies in the responsibility of each customer. The products are not authorized for use in safety-critical applications without RECOM's explicit written consent. A safety-critical application is an application where a failure may reasonably be expected to endanger or cause loss of life, inflict bodily harm or damage property. The applicant shall indemnify and hold harmless RECOM, its affiliated companies and its representatives against any damage claims in connection with the unauthorized use of RECOM products in such safety-critical applications.