

HF-A21-SMT

Embedded WiFi Module User Manual

V1.2

Overview of Characteristic

- ◇ Support **IEEE802.11b/g/n** Wireless Standards
- ◇ Support **TCP/UDP/HTTP** Network Protocols
- ◇ Support **UART/Ethernet** Data Interface
- ◇ Support Work As **STA/AP/AP+STA** Mode
- ◇ Support **Router/Bridge** Mode Networking
- ◇ Support **Internal/External** Antenna Option
- ◇ Support **AT+ Instruction Set** for Configuration
- ◇ Support **Friendly Web Configuration** Page
- ◇ Support **Heatbeat Signal**
- ◇ Support **Smart Link** Application Tools
- ◇ Support **UART Free/Auto-Frame** Function
- ◇ Single **+3.3V** Power Supply
- ◇ Small Size: **25 x 40mm**
- ◇ **FCC/CE** Certificated



TABLE OF CONTENTS

1. PRODUCT OVERVIEW	8
1.1. General Specification	8
1.2. Hardware Introduction	9
1.2.1. Pins Definition	9
1.2.2. Mechanical Size	11
1.2.3. On-board Chip Antenna	11
1.2.4. External Antenna	12
1.2.5. Evaluation Kit	14
1.2.6. Order Information	15
1.3. Hardware Reference Design	15
1.3.1. Hardware Typical Application	15
1.3.2. 10/100M Ethernet Interface	16
1.3.2.1. Ethernet Connection with Transformer	16
1.3.2.2. Ethernet Connection without Transformer	16
1.3.3. UART Interface	17
1.3.4. Power Interface	17
1.4. Software Reference Design	18
1.4.1. Transparent Transmission Mode	18
1.4.2. Configuration Mode	18
1.4.3. Multi-TCP Link Connection	19
1.4.4. TCPB Function	19
1.4.5. Palmodic Signal	19
2. FUNCTIONAL DESCRIPTION	21
2.1. Wireless Networking	21
2.1.1. Basic Wireless Network Based On AP (Infrastructure)	21
2.1.2. Wireless Network Based On AP Network	21
2.1.3. Wireless Network Based On AP+STA	22
2.2. Auto- Frequency Function	23
2.3. Security	23
2.4. UART Frame Scheme	23
2.4.1. UART Free-Frame	23
2.4.2. UART Auto-Frame	24
2.5. Address Binding	24
2.6. Ethernet Interface Communication	24
2.6.1. HF-A21-SMT Ethernet Interface Networking (As AP)	24
2.6.2. HF-A21-SMT Ethernet Interface Networking (As STA, N-Ver)	25
2.6.3. HF-A21-SMT Ethernet Interface Networking (As STA, Z-Ver)	25
2.7. Search Function for STA	25
2.8. Work Mode	25
2.9. Network Protocol	26
2.10. Parameters Configuration	26
2.11. Firmware Upgrade	27
3. OPERATION GUIDELINE	28
3.1. Configuration via Web Accessing	28
3.1.1. Open Web Management Interface	28

3.1.2.	Mode Selection Page.....	29
3.1.3.	AP Interface Setting Page	29
3.1.4.	STA Interface Setting Page	29
3.1.5.	Application Setting Page.....	30
3.1.6.	Device Management Page	31
3.2.	HF-A21-SMT Usage Introduction	31
3.2.1.	Software Debug Tools	31
3.2.2.	Network Connection.....	31
3.2.3.	Module Debug.....	32
3.3.	Typical Application Examples	34
3.3.1.	Wireless Control Application.....	34
3.3.2.	Remote Management Application.....	35
3.3.3.	Transparent Serial Port Application	35
3.3.4.	Wireless Data Acquisition Card Application.....	36
4.	AT+INSTRUCTION INTRODUCTION.....	37
4.1.	Configuration Mode	37
4.1.1.	Switch to Configuration Mode	37
4.2.	AT+ Instruction Set Overview	38
4.2.1.	Instruction Syntax Format.....	38
4.2.2.	AT+ Instruction Set	39
4.2.2.1.	AT+E	40
4.2.2.2.	AT+ENTM.....	40
4.2.2.3.	AT+NETP	40
4.2.2.4.	AT+UART	41
4.2.2.5.	AT+ UARTF.....	41
4.2.2.6.	AT+ UARTFT.....	42
4.2.2.7.	AT+ UARTFL.....	42
4.2.2.8.	AT+TMODE.....	42
4.2.2.9.	AT+WMODE.....	42
4.2.2.10.	AT+WSKEY	43
4.2.2.11.	AT+WSSSID	43
4.2.2.12.	AT+ WSLK.....	43
4.2.2.13.	AT+WEBU	44
4.2.2.14.	AT+WAP	44
4.2.2.15.	AT+WAKEY	44
4.2.2.16.	AT+HIDESSID	45
4.2.2.17.	AT+MSLP	45
4.2.2.18.	AT+WSCAN.....	45
4.2.2.19.	AT+ TCPLK	45
4.2.2.20.	AT + TCPDIS.....	46
4.2.2.21.	AT+ WANN	46
4.2.2.22.	AT+ LANN	46
4.2.2.23.	AT + DHCPDEN	47
4.2.2.24.	AT+ DHCPGW.....	47
4.2.2.25.	AT+ TCPTO.....	47
4.2.2.26.	AT+ MAXSK	47
4.2.2.27.	AT+TCPB.....	48
4.2.2.28.	AT+TCPPTB.....	48
4.2.2.29.	AT+TCPADDB.....	48

4.2.2.30.	AT+TCPTOB	48
4.2.2.31.	AT+TCPLKB	49
4.2.2.32.	AT+EPHY	49
4.2.2.33.	AT+STTC.....	49
4.2.2.34.	AT+DOMAIN.....	49
4.2.2.35.	AT+FRLDEN.....	49
4.2.2.36.	AT+RELD.....	50
4.2.2.37.	AT+Z.....	50
4.2.2.38.	AT+MID.....	50
4.2.2.39.	AT+WRMID	50
4.2.2.40.	AT+VER.....	50
4.2.2.41.	AT+H.....	50
4.2.2.42.	AT+FVEW	51
4.2.2.43.	AT+FVER.....	51
4.2.2.44.	AT+WMAC.....	51
4.2.2.45.	AT+PING	51
5.	PACKAGE INFORMATION	53
5.1	Shipping Information	53
APPENDIX A:	QUESTIONS AND ANSWERS	54
Q1:	How to configure transparent serial port application (TCP protocol) with two HF-A21-SMT modules?	54
Q2:	Where to Set HF-A21-SMT Module LAN IP and WAN IP through Web Page?	54
Q3:	How to configure transparent serial port application (UDP protocol) with two HF-A21-SMT modules?	55
Q4:	Where to set HF-A21-SMT module network protocol (TCP/UDP)?.....	55
Q5:	How to configure transparent serial port application: Two HF-A21-SMT modules all configured as STA and connection through AP?	56
Q6:	How to avoid IP address confliction when apply HF-A21-SMT module?	57
Q7:	PC works as server, all HF-A21-SMT modules works as data acquisition card and connect with PC, how to configure this application?.....	57
APPENDIX B:	EVB REFERENCE DESIGN	59
APPENDIX C:	CONTACT INFORMATION	60

LIST OF FIGURES

Figure 1.	HF-A21-SMT Appearance	9
Figure 2.	HF-A21-SMT Pins Map	9
Figure 3.	HF-A21-SMT Mechanical Dimension	11
Figure 4.	HF-A21-SMT Chip Antenna Keep Out Region	12
Figure 5.	Suggested Module Placement Region	12
Figure 6.	HF-A21-SMT Evaluation Kit	14
Figure 7.	HF-A21-SMT Order Information	15
Figure 8.	HF-A21-SMT Hardware Typical Application	15
Figure 9.	Ethernet Reference Design with Transformer	16
Figure 10.	Ethernet Reference Design without Transformer	17
Figure 11.	UART Interface Reference Design	17
Figure 12.	User MCU Software Flow Chart	18
Figure 13.	Multi-TCP Link Data Transmission Structure	19
Figure 14.	HF-A21-SMT Functional Architecture	21
Figure 15.	HF-A21-SMT Basic Wireless Network Structure	21
Figure 16.	HF-A21-SMT AP Network Structure	22
Figure 17.	HF-A21-SMT AP+STA Network Structure	22
Figure 18.	HF-A21-SMT Ethernet Interface Networking (As AP)	24
Figure 19.	HF-A21-SMT Ethernet Interface Networking (As STA, N-Ver)	25
Figure 20.	HF-A21-SMT Ethernet Interface Networking (As STA, Z-Ver)	25
Figure 21.	HF-A21-SMT Transparent Transmission Demo	26
Figure 22.	Open Web Management page	28
Figure 23.	Mode Selection Page	29
Figure 24.	AP Interface Setting Page	29
Figure 25.	STA Interface Setting Page	30
Figure 26.	Application Setting Page	30
Figure 27.	Device Management Page	31
Figure 28.	STA Interface Debug Connection	32
Figure 29.	AP Interface Debug Connection	32
Figure 30.	“CommTools” Serial Debug Tools	32
Figure 31.	“TCPUDPDbg” Tools Create Connection	33
Figure 32.	“TCPUDPDbg” Tools Setting	33
Figure 33.	“TCPUDPDbg” Tools Connection	34
Figure 34.	Wireless Control Application	34
Figure 35.	Remote Management Application	35
Figure 36.	Transparent Serial Port Application	35
Figure 37.	Wireless Data Acquisition Card Application	36
Figure 38.	HF-A21-SMT Default UART Port Parameters	37
Figure 39.	Switch to Configuration Mode	37
Figure 40.	”AT+H” Instruction for Help	38
Figure 41.	Shipping Information	53
Figure 42.	Configure Transparent Serial Port Connection (TCP)	54
Figure 43.	Module LAN IP Setting	55
Figure 44.	Module WAN IP Setting	55
Figure 45.	Configure Transparent Serial Port Connection (UDP)	55
Figure 46.	Module Network Protocols: TCP/Server	56
Figure 47.	Module Network Protocol: TCP/Client	56

Figure 48. Module Network Protocol: UDP 56
 Figure 49. Two HF-A21-SMT Modules Connection Through AP..... 57
 Figure 50. Wireless Data Acquisition Card Setting 58

LIST OF TABLES

Table 1 HF-A21-SMT Module Technical Specifications 8
 Table 2 HF-A21-SMT Pins Definition 9
 Table 3 HF-A21-SMT External Antenna Parameters 12
 Table 4 HF-A21-SMT Evaluation Kit Interface Description 14
 Table 5 HF-A21-SMT Web Access Default Setting..... 28
 Table 6 Error Code DescriptionHF-A21-SMT Web Access Default Setting..... 39
 Table 7 AT+ Instruction Set List 39

HISTORY

Ed. V1.0 Created on 1-14-2015.

Ed. V1.1 Modified on 2-03-2015. Modify power consumption.

Ed. V1.2 Modified on 10-19-2015. Modify size information.

1. PRODUCT OVERVIEW

1.1. General Specification

Table 1 HF-A21-SMT Module Technical Specifications

Class	Item	Parameters
Wireless Parameters	Certification	FCC/CE
	Wireless standard	802.11 b/g/n
	Frequency range	2.412GHz-2.484GHz
	Transmit Power	802.11b: +20 dBm (Max.)
		802.11g: +18 dBm (Max.)
		802.11n: +15 dBm (Max.)
		Configurable
	Receiver Sensitivity	802.11b: -89 dBm
		802.11g: -81dBm
		802.11n: -71dBm
Antenna Option	External:I-PEX Connector or PIN25 line out	
	Internal:On-board PCB antenna	
Hardware Parameters	Data Interface	UART: 1200bps - 230400bps
		Ethernet: 10Mbps/100Mbps
		GPIO,I2C,USB
	Operating Voltage	3.3V (+/-5%)
	Operating Current	Avg:170mA Peak:400mA
	Operating Temperature	-40°C - 85°C
	Storage Temperature	-45°C - 125°C
Dimensions and Size	25×40×3mm SMT	
Software Parameters	Network Type	STA /AP/AP+STA mode
	Security Mechanisms	WEP/WPA-PSK/WPA2-PSK/WAPI
	Encryption	WEP64/WEP128/TKIP/AES
	Work Mode	Transparent Transmission
	Serial command	AT+instruction set
	Network Protocol	TCP/UDP/ARP/ICMP/DHCP/DNS/HTTP
	Max. TCP Connection	32
	User Configuration	Web Server+AT command config.
	User Application SW	Support customized application SW Provide SDK package Provide smart link tools

1.2. Hardware Introduction



Figure 1. HF-A21-SMT Appearance

1.2.1. Pins Definition

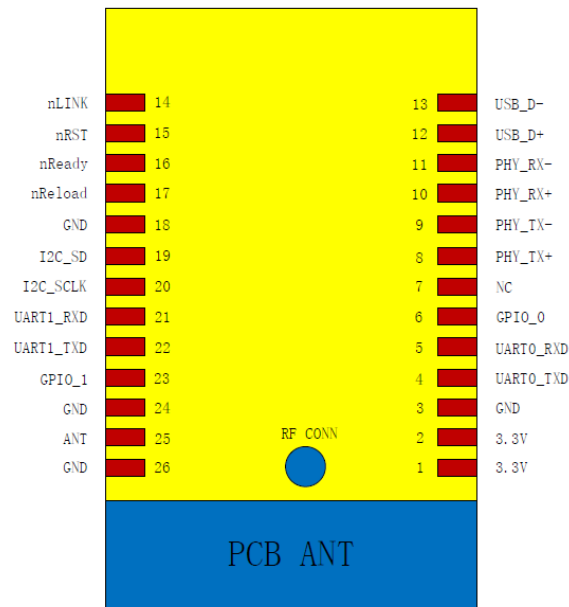

Figure 2. HF-A21-SMT Pins Map

Table 2 HF-A21-SMT Pins Definition

Pin	Description	Name	Direction	Note
3,18,24,26	GND	GND	Power	
1,2	VCC	3.3V	Power	3.3V @ 350mA
4	UART Data Transmit	UART_TXD	O	Note1

5	UART Data Receive	UART_RXD	I	
6	GPIO	GPIO_0	I/O	c
8	Ethernet Interface	PHY_TX+	O	Ethernet Data Interface.
9	Ethernet Interface	PHY_TX-	O	
10	Ethernet Interface	PHY_RX+	I	
11	Ethernet Interface	PHY_RX-	I	
12	USB_D+	USB_D+	I/O	USB Host Port
13	USB_D-	USB_D-	I/O	
14	WiFi status Indication	nLink	O	“1”- WIFI connection available, “0”- No WIFI connection
15	Module reset signal	nRST	I	“Low (0)” effective reset input. The reset duration should be kept more than 300ms
16	Indicate the module status of power on process	nReady	O	“0” or “Palmodic Signal” - Finish module boot up process; “1” - Module boot up not finish.
17	Restore configuration	nReload	I	Module will Restore factory default configuration after set this pin “0” more than 3s, then set “1”. This pin must 4.7K pull-up outside the module.
19	I2C_SD	I2C_SD	I/O	
20	I2C_SCLK	I2C_SCLK	O	
21	UART1 Data Receive	UART1_RXD	I	
22	UART1 Data Transmit	UART1_TXD	O	Note1
23	GPIO	GPIO_1	I/O	
25	2.4GHz Antenna	ANT	O	50 Ohm resistance control
7	Reserved	NC	NC	

Note1: These Pins should not add external pull-up resistor. It's configure pin for module bootup.

1.2.2. Mechanical Size

HF-A21-SMT modules physical size as follows:

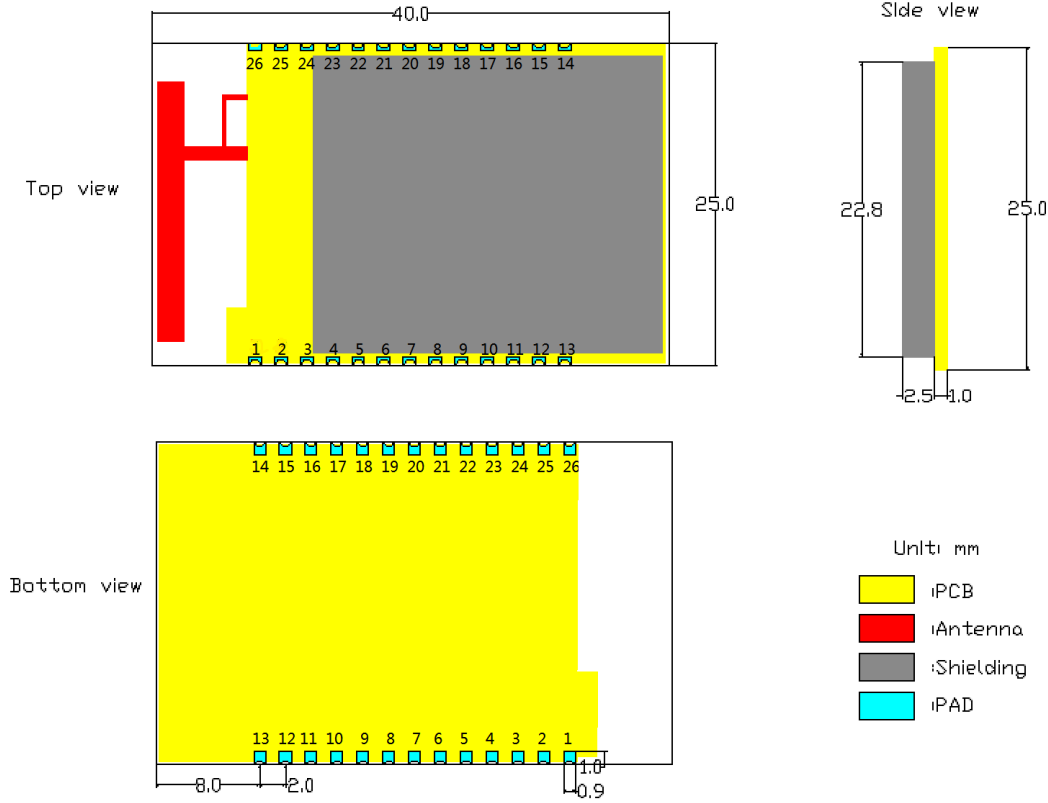

Figure 3. HF-A21-SMT Mechanical Dimension

1.2.3. On-board Chip Antenna

HF-A21-SMT module support internal on-board chip antenna option. When customer select internal antenna, you shall comply with following antenna design rules and module location suggestions:

- For customer PCB, RED color region (7.5x25mm) can't put component or paste GND net;
- Antenna must away from metal or high components at least 10mm;
- Antenna can't be shielded by any metal enclosure; All cover, include plastic, shall away from antenna at least 10mm;

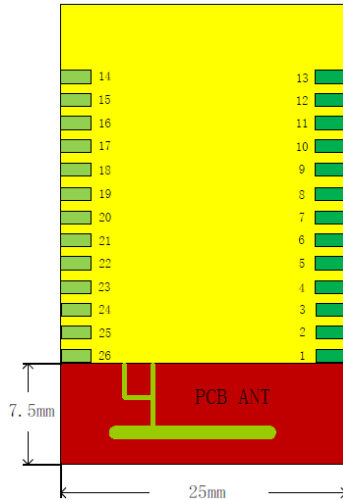

Figure 4. HF-A21-SMT Chip Antenna Keep Out Region

High-Flying suggest HF-A21-SMT module better locate in following region at customer board, which to reduce the effect to antenna and wireless signal, and better consult High-Flying technical people when you structure your module placement and PCB layout.

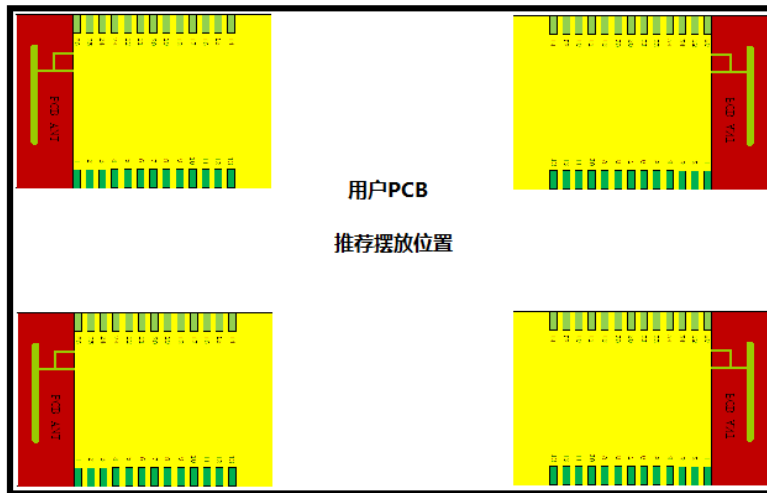

Figure 5. Suggested Module Placement Region

1.2.4. External Antenna

HF-A21-SMT modules support internal antenna and external antenna option for user dedicated application. If user select external antenna, HF-A21-SMT modules must be connected to the 2.4G antenna according to IEEE 802.11b/g/n standards.

The antenna parameters required as follows:

Table 3 HF-A21-SMT External Antenna Parameters

Item	Parameters
Frequency range	2.4~2.5GHz
Impedance	50 Ohm

VSWR	2 (Max)
Return Loss	-10dB (Max)
Connector Type	I-PEX or populate directly

1.2.5. Evaluation Kit

High-Flying provides the evaluation kit to promote user to familiar the product and develop the detailed application. The evaluation kit shown as below, user can connect to HF-A21-SMT module with the RS-232 UART port, 100M Eth port or Wireless port to configure the parameters, manage the module or do the some functional tests.

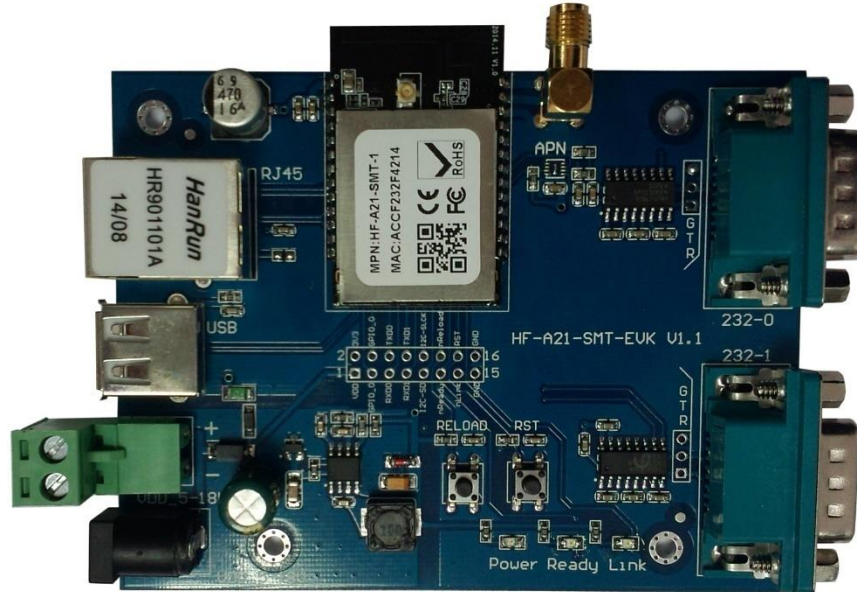

Figure 6. HF-A21-SMT Evaluation Kit

The external interface description for evaluation kit as follows:

Table 4 HF-A21-SMT Evaluation Kit Interface Description

Function	Name	Description
External Interface	DC-Jack	5V@1A Power input: DC-Jack
	DC 5V	5V@1A Power input: 2-Pin
	COM1 UART	DB9, UART, Connect PC serial port
	COM2 UART1	DB9, UART1, Connect PC serial port
	RJ-45	100M Ethernet Interface
	USB Host	Seserved USB (Type A)
	DIP-16	Extended 16-pin functional interface
	ATT	2.4GHz , SMA external antenna interface
LED	Power (Red)	3.3V Power Indicator
	nLink	nLink/GPIO-Pin 14 Indicator
	nReady	nReady/GPIO-Pin 16 Indicator
Button	Reset	Used to reset the module.
	Reload	Module restore to factory default configuration.

1.2.6. Order Information

Base on customer detailed requirement, HF-A21-SMT series modules provide different variants and physical type for detailed application.

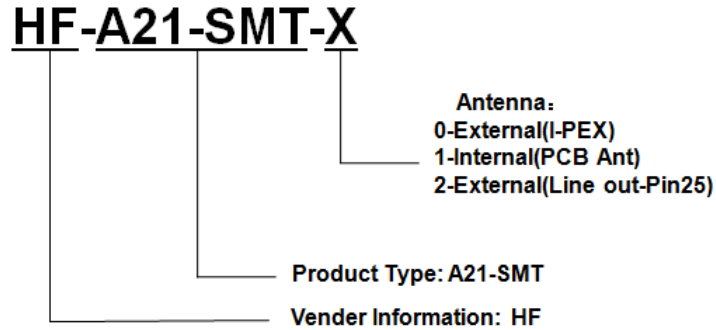

Figure 7. HF-A21-SMT Order Information

1.3. Hardware Reference Design

1.3.1. Hardware Typical Application

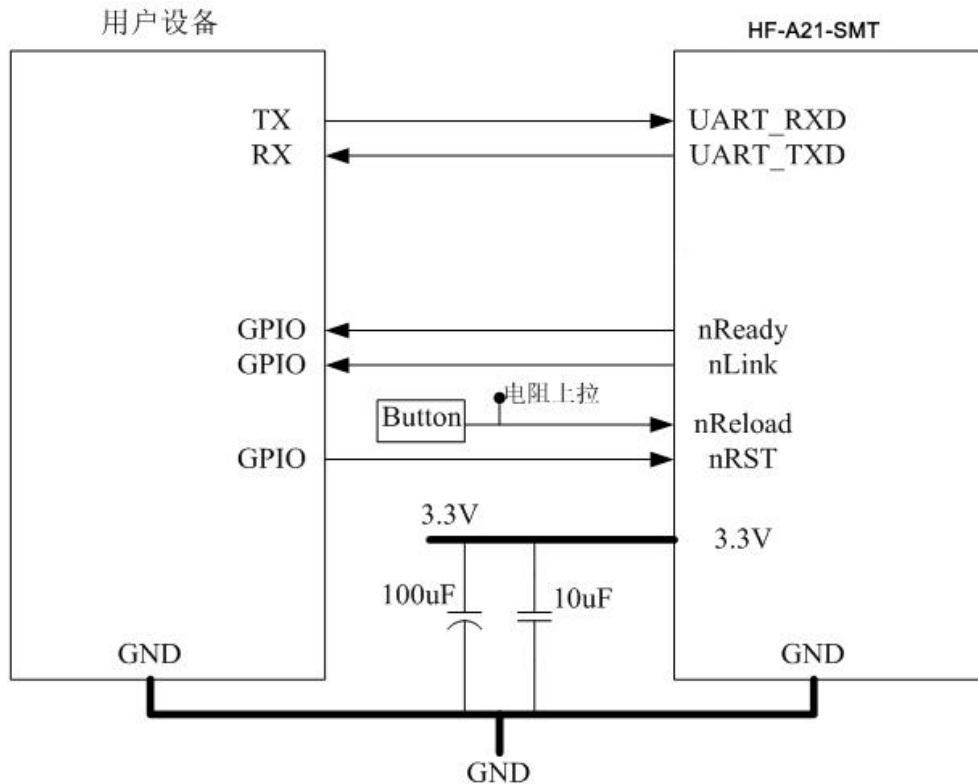

Figure 8. HF-A21-SMT Hardware Typical Application

Notes:

nRST- Module hardware reset signal. Input. Logics “0” effective.

There is 22K&4.7uF reset circuit. When module power up or some issue happened, MCU need assert nRST signal “0” at least 300ms, then set” 1” to keep module fully reset.

nReady- Module boot up ready signal. Output. Logics “0” effective.

The module will output “0” “or “Palmodic Signal” after normal boot up. This signal used to judge if module finish boot up and ready for application or working at normal mode.

nLink- Module WIFI connection indication. Output.

When module connect to AP (STA mode) or some WiFi STA connect to module (AP mode), the module will output “0”. This signal used to judge if module already at WiFi connection status.

nReload- Module restore to factory default configuration.Input. Logics “0” effective.

User can assert nReload signal “0” more than 3’s through button or MCU pin, then release, module will restore to factory default configuration and re-start boot up process. **User need add 4.7K~10K Ohm pull-up resistor external the module. If not use this function, then can use AT command AT+FRLDEN=off to disable it.**

UART_TXD/RXD- UART port data transmit and receive signal.

1.3.2. 10/100M Ethernet Interface

HF-A21-SMT modules provide one 10/100M Ethernet PHY layer interface for data transition or user configuration. This Ethernet support with transformer and without transformer (PHY-to-PHY) 2 kinds of connection.

1.3.2.1. Ethernet Connection with Transformer

User board put Ethernet transformer and RJ-45 connector. This is a general 10/100M Ethernet phy layer connection. The reference design as following:

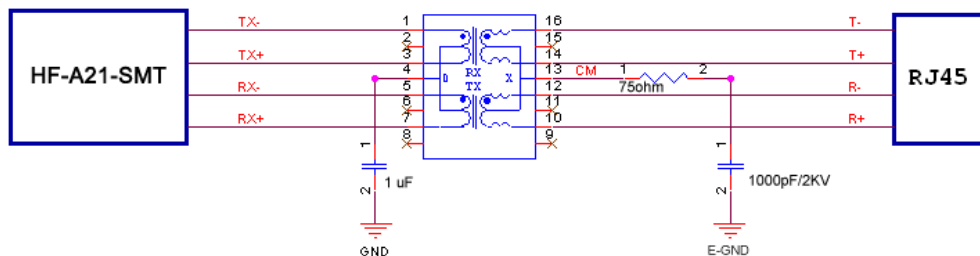

Figure 9. Ethernet Reference Design with Transformer

1.3.2.2. Ethernet Connection without Transformer

For this application, Ethernet will work as internal data transmission interface and save one transformer and RJ-45 connector. Ethernet PHY-to-PHY connection will use AC coupled connection. This is a space and cost optimized solution. Hardware reference design as following: Note: VCC signal at reference design shall base on user board PHY chipset voltage level, such as 2.5V power supply for general Ethernet PHY chipset.

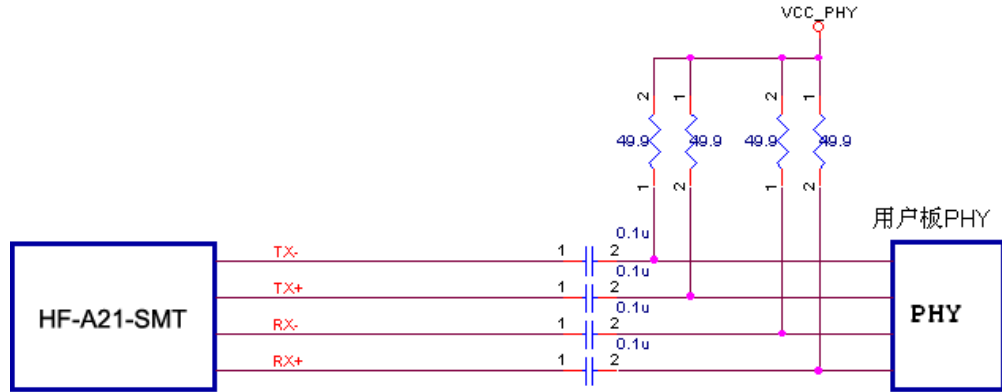

Figure 10. Ethernet Reference Design without Transformer

1.3.3. UART Interface

UART interface is the serial data transmission interface mainly used for HF-A21-SMT modules. User can add RS-232 chipset on user board and convert the signal to RS-232 voltage to communicate with outside equipment or sensors. HF-A21-SMT modules UART interface include 4 general signals: TXD/RXD/RTS/CTS. The hardware reference design with RS-232 chipset as following:

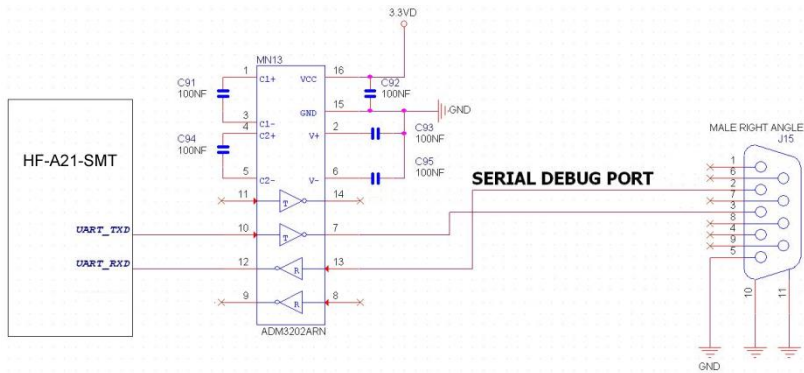

Figure 11. UART Interface Reference Design

Notes: TXD pin is also hardware configuration pin internal module. So this pin MUST pull-down during module power up. HF0A11x modules provide internal pull-down resistor, user can't add pull-up/pull-down resistor on user board, which may cause module can't work.

1.3.4. Power Interface

HF-A21-SMT module support single +3.3V power supply. The peak current shall about 350mA and normal WiFi working current shall about 200mA. The power save (WiFi OFF) mode will about 100mA

Decoupling at power pin suggested, At least one 100uF and one 10uF capacitor required at user board and put near module power input pin will increase the reliability and performance.

1.4. Software Reference Design

When HF-A21-SMT modules boot up phase, the general user board MCU software flow chart will as following:

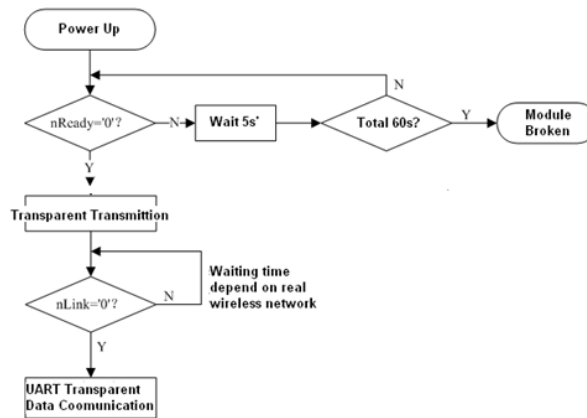

Figure 12. User MCU Software Flow Chart

When HF-A21-SMT modules boot up, user can select one work mode base on the setting, and user can switch to the configuration mode at any kinds of work mode.

1.4.1. Transparent Transmission Mode

HF-A21-SMT modules support serial interface transparent transmission mode. The benefit of this mode is achieves a plug and play serial data port, and reduces user complexity furthest. In this mode, user should only configure the necessary parameters. After power on, module can automatically connect to the default wireless network and server.

As in this mode, the module's serial port always work in the transparent transmission mode, so users only need to think of it as a virtual serial cable, and send and receive data as using a simple serial. In other words, the serial cable of users' original serial devices is directly replaced with the module; user devices can be easy for wireless data transmission without any changes.

The transparent transmission mode can fully compatible with user's original software platform and reduce the software development effort for integrate wireless data transmission.

Notes: Transparent transmission mode as a low level phy layer data transmitting can't keep zero error rates by itself. User can enable UART port's hardware flow control CTS/RTS function or though higher layer protocol such as TCP to lower error rate and mange the data completeness. High-Flying recommend when doing large amounts of data transmitting in transparent transmission mode, hardware flow control should be enabled, so as to fully ensure reliable data transmission. In the applications which doesn't need flow control, users can simply leave RTS / CTS pin vacant.

1.4.2. Configuration Mode

In configuration mode, user can finish HF-A21-SMT module configuration management and parameters setting work. In work mode (Transparent Transmission), user can switch to the

configuration mode through AT+instruction, detailed switch operation refer to “AT+ instruction set” chapter.

1.4.3. Multi-TCP Link Connection

When HF-A21-SMT module configured as TCP Server, it supports Multi-TCP link connection, and maximum 32 TCP clients permit to connect to HF-A21-SMT module. User can realize multi-TCP link connection at each work mode.

Multi-TCP link connection will work as following structure:

Upstream: All dates from different TCP connection or client will be transmitted to the serial port as a sequence.

Downstream: All data from serial port (user) will be duplicate and broadcast to every TCP connection or client.

Detailed multi-TCP link data transmission structure as following figure:

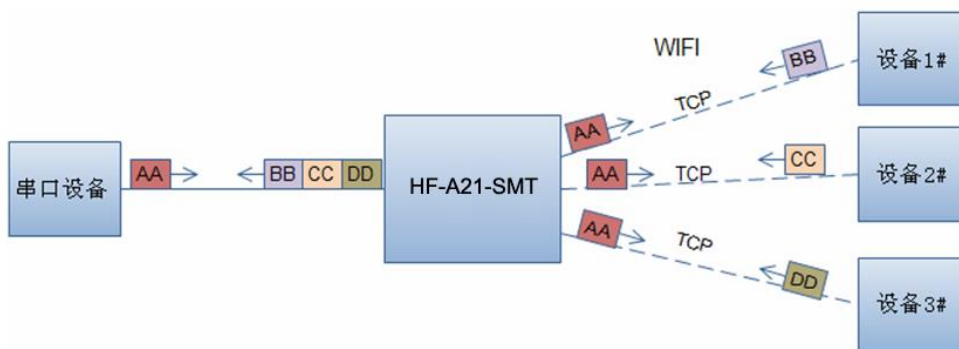

Figure 13. Multi-TCP Link Data Transmission Structure

1.4.4. TCPB Function

HF-A21-SMT support 2xTCP function, which means module can support 2 network connections at the same time. The 2nd network connection called TCPB. TCPB only works as TCP Client and its configuration can only through AT command, not Web configuration supported. The command as following,

- AT+TCPB=on, Enable TCPB function;
- AT+TCPPTB=<port>, Set TCPB port number;
- AT+TCPADDB=<IP or domain>, Set TCPB's server address;
- AT+TCPTOB=<time>, Set TCPB timeout;
- AT+TCPLKB, Query TCPB link status;

Detailed command description refer to AT instruction chapter. After enable TCPB function, two network interfaces' work mode like “Multi-TCP Link”, All dates from each TCP connection will be transmitted to the serial port as a sequence and all data from serial port (user) will be duplicate and broadcast to each TCP connection.

1.4.5. Palmodic Signal

Base on selected factory default setting, nReady signal can have two output statuses:

- Status One: The module will output “0” after normal boot up. This signal used to judge if module finish boot up and ready for application.
- Status Two: The module will output “Palmodic Signal” after normal boot up. The palmodic signal is 0.5Hz square wave with dutyfactor 1:1. User can query this signal to judge if module is active “live” or need to re-boot. When module switches to command mode, it will output “0”, which used to distinguish work mode and command mode.

Notes:

This function is user selected factory setting and RELD instruction will not effective for this function. If user not requires this function, the default factory setting is Status One. Contact with Hi-flying for more detailed support.

2. FUNCTIONAL DESCRIPTION

2.1. Wireless Networking

HF-A21-SMT module can be configured as both wireless STA and AP base on network type. Logically there are two interfaces in HF-A21-SMT. One is for STA, and another is for AP. When HF-A21-SMT works as AP, other STA equipments are able to connect to wireless LAN via HF-A21-SMT module. Wireless Networking with HF-A21-SMT is very flexible. Following figure shows the functional architecture of HF-A21-SMT module:

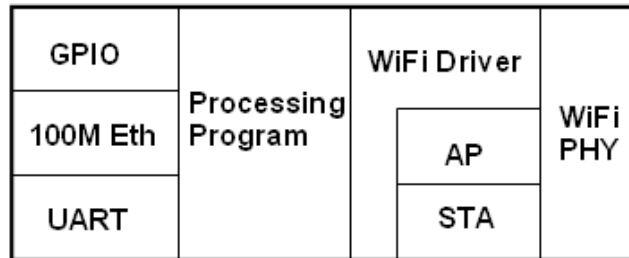

Figure 14. HF-A21-SMT Functional Architecture

Notes:

AP: that is the wireless Access Point, the founder of a wireless network and the centre of the network nodes. The wireless router we use at home or in office may be an AP.

STA: short for Station, each terminal connects to a wireless network (such as laptops, PDA and other networking devices) can be called with a STA device.

2.1.1. Basic Wireless Network Based On AP (Infrastructure)

Infrastructure: it's also called basic network. It built by AP and many STAs which join in. The characters of network of this type are that AP is the centre, and all communication between STAs is transmitted through the AP. The figure following shows such type of networking.

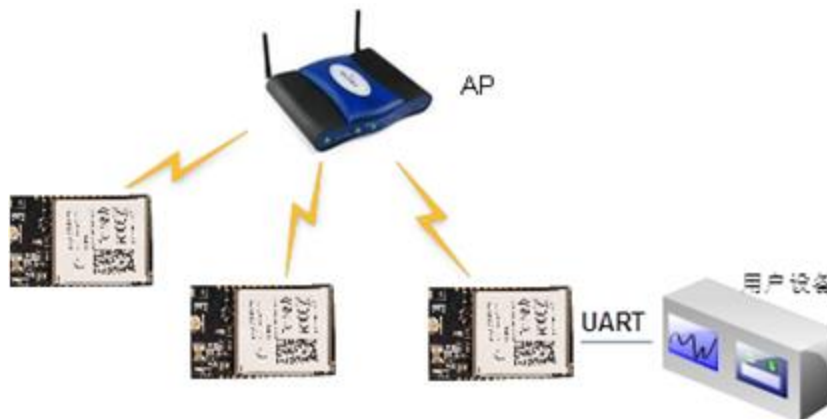

Figure 15. HF-A21-SMT Basic Wireless Network Structure

2.1.2. Wireless Network Based On AP Network

As showing in the figure below, HF-A21-SMT (1) can be treat as an AP, and HF-A21-SMT (2), HF-A21-SMT (3) and the laptop are STAs connected to HF-A21-SMT (1). Meanwhile, all HF-A21-SMT modules can connected to user device via UART interface. All HF-A21-SMT modules can be operated and managed through the laptop. So it is convenient to O&M all HF-A21-SMT modules. Moreover, in such AP network structure, the whole coverage of a wireless network can be extended easily.

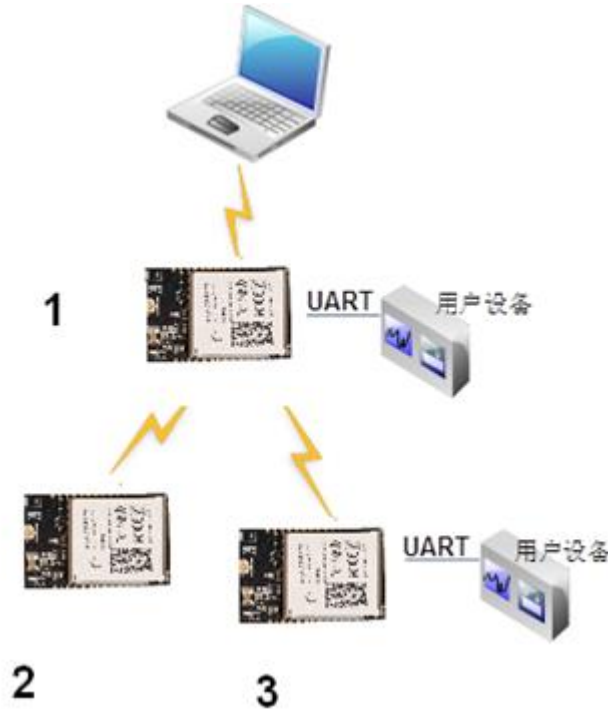

Figure 16. HF-A21-SMT AP Network Structure

2.1.3. Wireless Network Based On AP+STA

HF-A21-SMT module support AP+STA network mode, means module support one AP interface and one STA interface at the same time, as following figure,

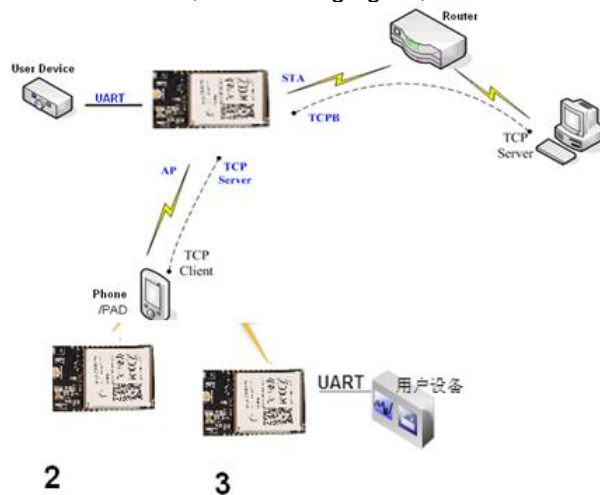

Figure 17. HF-A21-SMT AP+STA Network Structure

When module enables AP+STA function, Module's STA interface can connect with router and connect to TCP server in the network. At the same time, module's AP interface is also active and permit phone/PAD to connect through TCPB, then phone/PAD can control user device and setting the module parameters,

The advantage of AP+STA mode is:

- Users can easily setting and track user device through Phone/PAD and not change the original network setting.
- Users can easily setting module's parameters through WiFi when module works as STA mode.

AP+STA Mode Setting:

AP+STA mode need serial AT command to enable as follows:

- **AT+FAPSTA=on**, Enable AP+STA mode;
- Then, when you configure module works as STA mode, it's AP interface still active;

AP+STA Mode Notes:

When user enable AP+STA function, the STA port need to keep connected with other router (AP), or STA port will have to scan the AP frequently, which will affect AP port function and may cause some data loss.

So,if user confirm STA port can't connect with AP at some time, user can disable the STA scan through the following command:

- **AT+STTC=on/off**, on: Scan AP; off: No scan AP.
After re-start module, this command not saved;
- **AT+FSTTC=on/off**;
This command is saved after re-starting the module;

2.2. Auto- Frequency Function

When module works as STA, HF-A21-SMT will adjust its wireless channel to keep the same channel with associated AP and connect in.

When module works as AP and HF-A21-SMT enable Auto-frequency function, then when module boot up, it will select the best wireless channel based on surrounding environment.

2.3. Security

HF-A21-SMT module supports multiple wireless encryption mechanisms, and enables to protect the security of user's data transmission, the mechanisms include:

- ◆ WEP
- ◆ WPA-PSK/TKIP
- ◆ WPA-PSK/AES
- ◆ WPA2-PSK/TKIP
- ◆ WPA2-PSK/AES

2.4. UART Frame Scheme

2.4.1. UART Free-Frame

HF-A21-SMT support UART free-frame function. If user select open this function, module will check the intervals between any two bytes when reciving UART data. If this interval time exceeds defined value (50ms default), HF-A21-SMT will think it as the end of one frame and transfer this free-frame to WiFi port, or HF-A21-SMT will receive UART data untill 4K bytes, then transfer 4KB frame to WiFi port.

HF-A21-SMT's default interval time is 50ms. User can also set this interval to fast (10ms) through AT command. But user have to consider if user MCU can send UART data with 10ms interval ,or the UART data may be divide as fragment.

Through AT command: AT+FUARTTE=fash/normal, user can set the interval time: fast (10ms) and normal (50ms). This command is factory default setting command and AT+RELD can't change its value.

2.4.2. UART Auto-Frame

HF-A21-SMT support UART auto-frame function. If user select open this function and setting auto-frame trigger length and auto-frame trigger time parameters, then module will auto framing the data which received from UART port and transmitting to the network as pre-defined data structure.

- **Auto-frame trigger length:** The fixed data length that module used to transmitting to the network.
- **Auto-frame trigger time:** After the trigger time, if UART port received data can't reach auto-frame trigger length, then module will transmitting available data to the network and bypass the auto-frame trigger length condition.

Detailed UART auto-frame function can refer to AT+ instruction set "UARTF/UARTFT/UARTFL" introduction.

2.5. Address Binding

HF-A21-SMT module supports the feature of binding the BSSID address of target network. According to the provisions of 802.11 protocol, different wireless networks can have a same network name (i.e. SSID / ESSID), but must correspond to a unique BSSID address (i.e. MAC address). Illegal intruders can create a wireless network with the same SSID / ESSID, it will make STAs in the network to join to the illegal AP, thereby and then network leakage happen.

Users can prevent STA from joining to illegal network by binding the BSSID address, to improve wireless network security.

2.6. Ethernet Interface Communication

HF-A21-SMT module provides one 10/100M Ethernet interface. With this Ethernet interface, user can easily realize the three interface (WiFi, UART, and Ethernet) intercommunication and networking. HF-A21-SMT module can configured as **Bridge Mode** or **Router Mode** base on different networking technology.

Notes: The Ethernet function is disabled by default because of the large power consumption. Users may input "AT+FEPHY=on" and reset to enable Ethenet. HF-A21-SMT need different configuration to support different Ethenet Networking mode (Such as "N-Ver" and "Z-Ver" as following, which need AT+FVER=n to switch to N-Ver or AT+FVER=z to switch to Z-Ver).

2.6.1. HF-A21-SMT Ethernet Interface Networking (As AP)



Figure 18. HF-A21-SMT Ethernet Interface Networking (As AP)

For above networking, HF-A21-SMT module works as AP and also the centre of this network. All devices' IP address in this network shall use the same network segment with HF-A21-SMT and they can intercommunication with this method.

2.6.2. HF-A21-SMT Ethernet Interface Networking (As STA, N-Ver)



Figure 19. HF-A21-SMT Ethernet Interface Networking (As STA, N-Ver)

For above networking, HF-A21-SMT module works as STA (Firmware is N-Version), and module configured as router mode. When module connect to AP, it will get wireless port IP address from AP (For example: 192.168.1.100). At the same time, module also form a subnet (Default 10.10.100.254) and all devices connected to module Ethernet interface will get assigned IP address (For example: 10.10.100.101). So for above networking, PC1 at internal subnet can initiate a connection to PC2 (For HF-A21-SMT works as router mode), but PC2 can't active initiate a connection to PC1.

2.6.3. HF-A21-SMT Ethernet Interface Networking (As STA, Z-Ver)



Figure 20. HF-A21-SMT Ethernet Interface Networking (As STA, Z-Ver)

For above networking, HF-A21-SMT module works as STA (Firmware is Z-Version), and module configured as bridge mode. When module connect to AP, all devices connected to module Ethernet interface will get assigned IP address from AP (For example: 192.168.1.101). For module works as bridge mode, it can be treated as a transparent device and PC1, PC2 can communicate without any limit. But in this networking, HF-A21-SMT module needs assign a static LAN IP address (For example: 192.168.1.10) if module also needs communication with AP or configuration through web page.

2.7. Search Function for STA

When using web configuration STA Interface Setting Page, user can push "Search" button to find surrounding AP, and find a AP to associated.

2.8. Work Mode

HF-A21-SMT modules provide two kinds of work mode: Transparent transmission mode. Transparent transmission mode achieves a plug and play serial data port, and reduces user

complexity. User can save the configuration information to the flash of HF-A21-SMT, then module will go into the appointed work mode after power up.

For a module which already finished parameters setting, it will try to connect a wireless network and server with these parameters after power up, and serial interface is also active with pre-configured parameters. Then all the data is transferred directly between serial interface and Wifi interface without any interpreted.

The parameters which need to configure include:

- **Wireless Network Parameters**
 - Wireless Network Name (SSID)
 - Security Mode
 - Encryption Key
- **TCP/UDP Linking Parameters**
 - Protocol Type
 - Link Type (Server or Client)
 - Target Port ID Number
 - Target Port IP Address
- **Serial Port Parameters**
 - Baud Rate
 - Data Bit
 - Parity (Check) Bit
 - Stop Bit
 - Hardware Flow Control
- **Work Mode Selection**
 - Transparent transmission

Transparent transmission demo as showing in the following figure, a HF-A21-SMT module can be taken as a virtual serial line when UART interface working in transparent transmission mode. And user device will realize wireless data transmission almost without any changes.



Figure 21. HF-A21-SMT Transparent Transmission Demo

2.9. Network Protocol

HF-A21-SMT module supports TCP/UDP network protocol and the port parameters can be set via web accessing or AT+instruction set.

2.10. Parameters Configuration

HF-A21-SMT module supports two methods to configuration parameters: **Web Accessing** and **AT+instruction set**.

Web accessing means users can configure parameters through Web browser. When HF-A21-SMT module connected to wireless network, parameters configuration is done on a PC

connected to the same wireless network. AT+instruction set configuration means user configure parameters through serial interface command. Refer to “AT+instruction set” chapter for more detail.

Notes:

High-Flying can customized the parameters setting as customer request and ship HF-A21-SMT modules with these parameters as factory default configuration. It will reduce user’s module configuration time for mass production. Also, if user need different parameters setting for every module, High-Flying can provide the **auto-configuration tool** to speed up the module conguration duration. Please contact High-Flying technical interface to acquire this tool if required.

2.11. Firmware Upgrade

HF-A21-SMT module supports firmware upgrade online; User can upgrade firmware via web access.

3. OPERATION GUIDELINE

3.1. Configuration via Web Accessing

When first use HF-A21-SMT modules, user may need some configuration. User can connect to HF-A21-SMT module's wireless interface with following default setting information and configure the module through laptop.

Table 5 HF-A21-SMT Web Access Default Setting

Parameters	Default Setting
SSID	HF-A21x_AP
IP Address	10.10.100.254
Subnet Mask	255.255.255.0
User Name	admin
Password	admin

3.1.1. Open Web Management Interface

Step 1: Connect laptop to SSID "HF-A21x_AP" of HF-A21-SMT module via wireless LAN card;

Step 2: After wireless connection OK. Open Wen browser and access "<http://10.10.100.254>";

Step 3: Then input user name and password in the page as following and click "OK" button.



Figure 22. Open Web Management page

The HF-A21-SMT web management page support English and Chinese language. User can select language environment at the top right corner and click "Apply" button.

The main menu include five pages: "Mode Selection", "AP Interface Setting", "STA Interface Setting", "Application Setting", and "Device Management"

Notes:

Default, High-Flying suggests all Web management related operation shall execute at AP mode. (Even you need configure STA parameters and want module works as STA mode). If user selects STA mode and still want to configurate the module through Web browser, you have to access the module through another AP (and get the module IP address through this AP.)

3.1.2. Mode Selection Page

This page use to setting the module working mode (Transparent Transmission) and wireless networking mode (AP and STA mode).

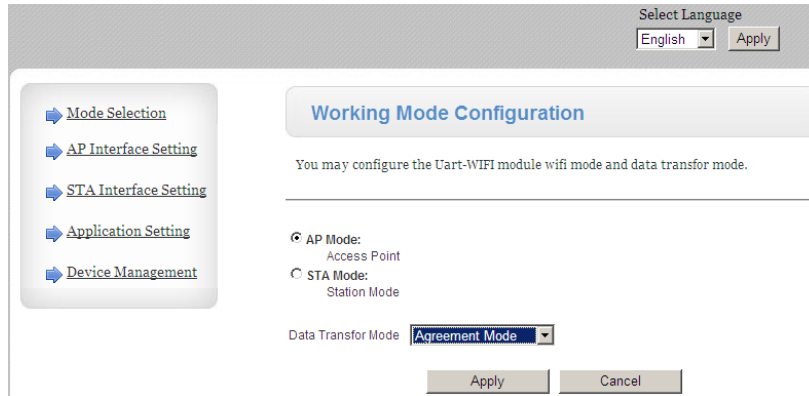

Figure 23. Mode Selection Page

3.1.3. AP Interface Setting Page

This page use to setting the parameters when HF-A21-SMT module works as AP.

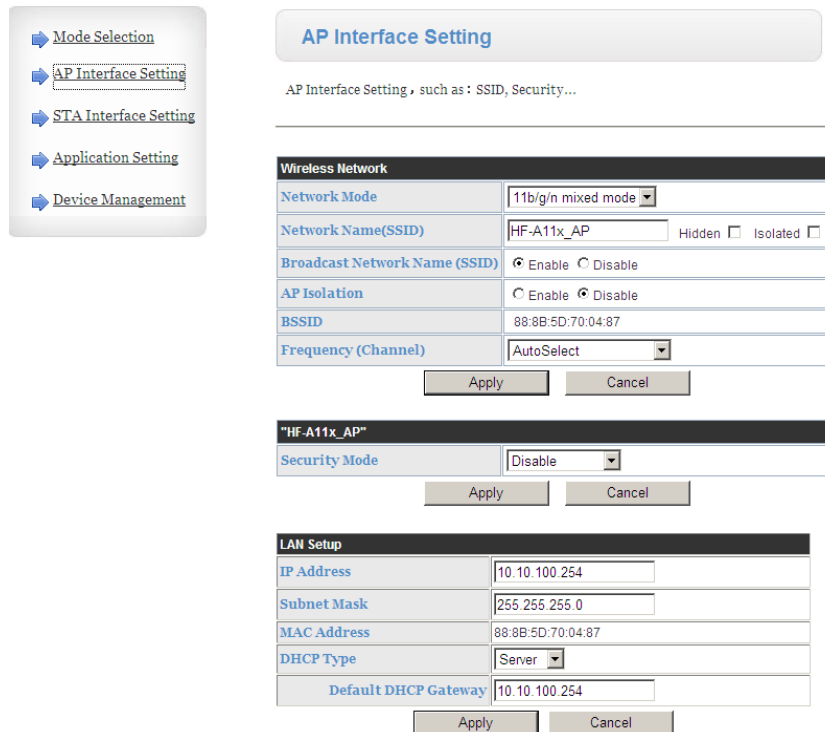

Figure 24. AP Interface Setting Page

3.1.4. STA Interface Setting Page

This page use to setting the parameters when HF-A21-SMT module works as STA. Such as SSID of AP which module need to connected, and also select the networking type: DHCP or static IP address.

- Mode Selection
- AP Interface Setting
- STA Interface Setting
- Application Setting
- Device Management

STA Interface Setting

You could configure STA interface parameters here.

STA Interface Parameters

SSID	HF-A11x_AP
MAC Address (Optional)	
Security Mode	OPEN
Encryption Type	None

WAN Connection Type: DHCP (Auto config)

DHCP Mode

Hostname (optional)	
---------------------	--

Figure 25. STA Interface Setting Page

3.1.5. Application Setting Page

This page use to setting the parameters of serial port communication, such as UART setting and high layer network protocol setting which used support serial communication.

- Mode Selection
- AP Interface Setting
- STA Interface Setting
- Application Setting
- Device Management

AP Interface Setting

AP Interface Setting , such as : SSID, Security...

Wireless Network

Wifi-Uart Setting

You could configure the Uart parameters and network parameters of the wifi-uart application.

Uart Setting

Baudrate	57600
Data Bits	8
Parity	None
Stop	1
CTSRTS	Disable

Net Setting

Mode	Server
Protocol	TCP
Port	8899
IP Address	10.10.10.100
TCP Time out (MAX 600 s)	300

Figure 26. Application Setting Page

Notes:

Generally, Network protocols support three modes: **TCP Server, TCP Client, and UDP**. UDP has no server and client requirement according to standard.

Besides module working as TCP Server (IP address not required in this mode). User must set the IP address of the device which need communicate with HF-A21-SMT module.

Also the Port ID between two sides of the communication devices must keep the same.

3.1.6. Device Management Page

This page use to manage HF-A21-SMT module general setting, such as administrator setting, restart module button, restore factory default setting button, and update firmware through webpage.

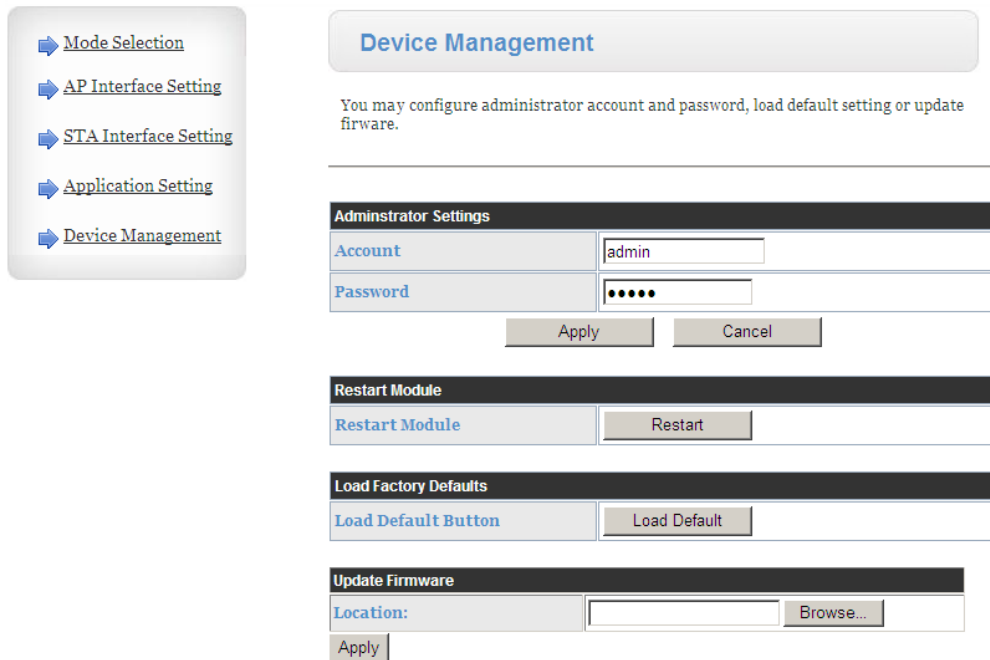

Figure 27. Device Management Page



Notes:

Restart module button: When you setting the parameters of different web pages, you will click “Apply” button to confirm the setting, but the setting take effect only after user click the “Restart” button here, the module will re-boot up and reflash the memory information with new changes.

3.2. HF-A21-SMT Usage Introduction

3.2.1. Software Debug Tools

High-Flying use two common software tools debugging and applying HF-A21-SMT modules. (User can also select other tools used to debug serial and Ethernet port).

- Serial Debugging Software: ComTools  ComTools.exe
- Ethernet Debugging Software: TCPUDPDbg  TCPUDPDbg.exe

3.2.2. Network Connection

User can select two methods to connect HF-A21-SMT module base on dedicated application.

➤ **Use HF-A21-SMT STA interface**

HF-A21-SMT and debug PC2 connect to a wireless AP, another PC1 (or user device) connect to HF-A21-SMT module with serial port:



Figure 28. STA Interface Debug Connection

➤ **Use HF-A21-SMT AP interface**

Debug PC2 connect to HF-A21-SMT through wireless connection, another PC1 (or user device) connect to HF-A21-SMT module with serial port.



Figure 29. AP Interface Debug Connection

3.2.3. Module Debug

PC1 open “CommTools” program, setting the same serial port parameters with HF-A21-SMT module and open serial port connection.

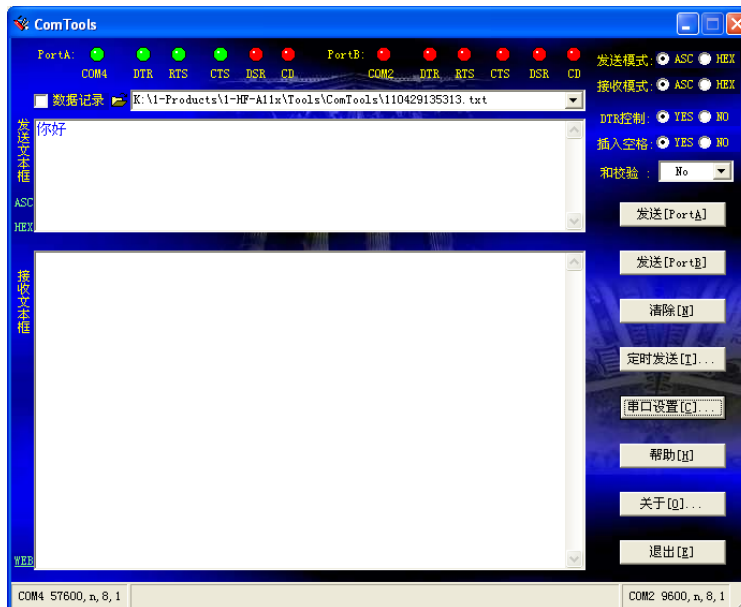

Figure 30. “CommTools” Serial Debug Tools

PC2 open “TCPUDPDbg” program, and create a new connection. If HF-A21-SMT configured as Server mode, “TCPUDPDbg” Tools shall create “Client” mode connection. Or otherwise, create a “Server” mode connection.

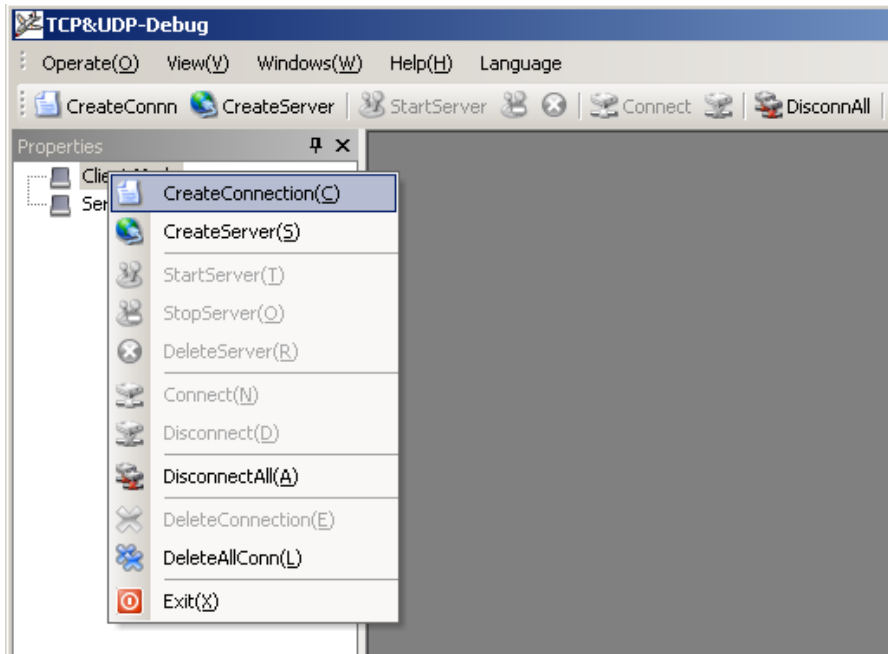

Figure 31. “TCPUDPDbg” Tools Create Connection

Then setting the TCP/UDP connection parameters. Default as following:

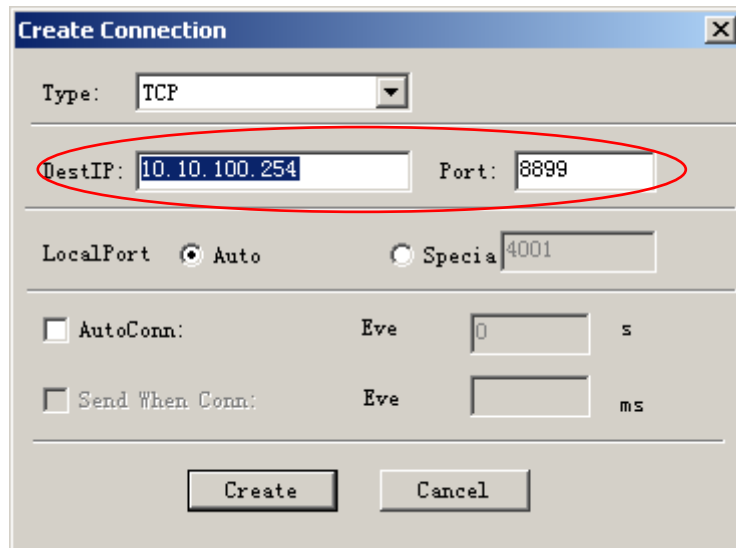

Figure 32. “TCPUDPDbg” Tools Setting

Then, click “Create” button to create a connection.

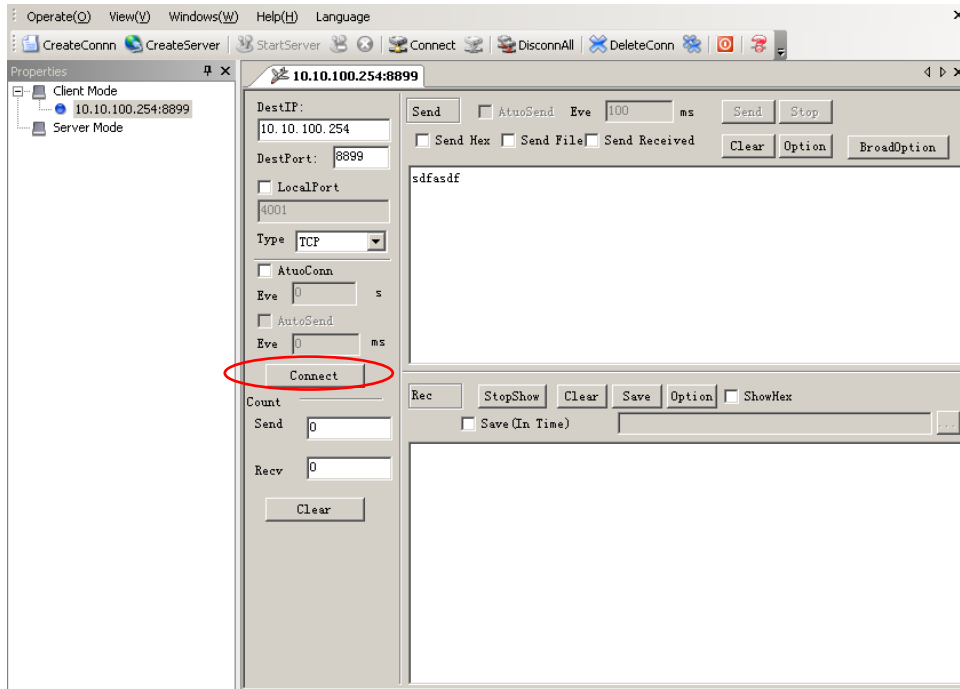

Figure 33. “TCPUDPDbg” Tools Connection

Now, in transparent transmission mode (HF-A21-SMT default setting), data can be transferred from “CommTools” program to “TCPUDPDbg” program, or in reverse. You can see data in receiver side will keep same as in sender side.

3.3. Typical Application Examples

3.3.1. Wireless Control Application



Figure 34. Wireless Control Application

For this wireless control application, HF-A21-SMT works as AP mode. Module’s serial port connects to user device. So, control agent (Smart phone for this example) can manage and control the user device through the wireless connection with HF-A21-SMT module.

3.3.2. Remote Management Application

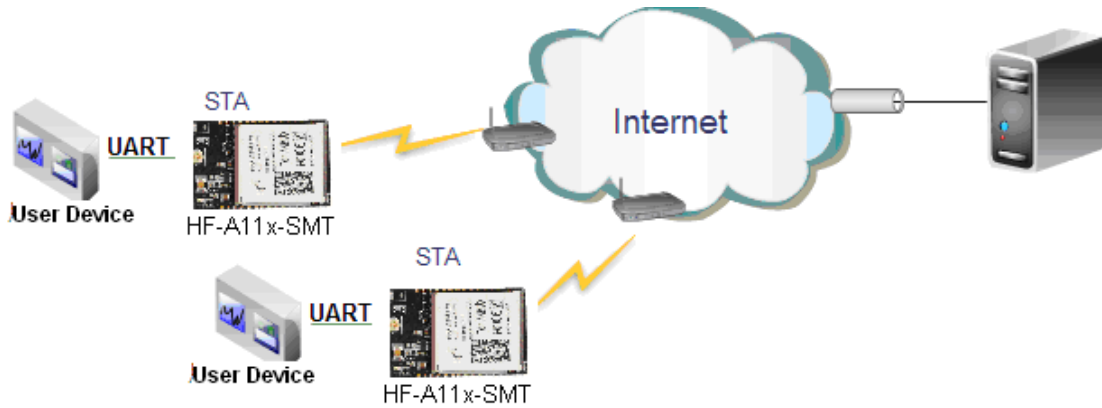

Figure 35. Remote Management Application

For this remote management application, HF-A21-SMT works as STA mode and connects to Internet through wireless AP. Module configured as TCP Client and communicates with remote TCP server at Internet. Module's serial port connects to user device.

So, user device's data or sampling information can send to remote TCP server for storage or processing. Also remote TCP server can send command to control and manage the user device through the wireless network.

3.3.3. Transparent Serial Port Application

For this transparent serial port application, two HF-A21-SMT modules connect as below figures to build up a transparent serial port connection.

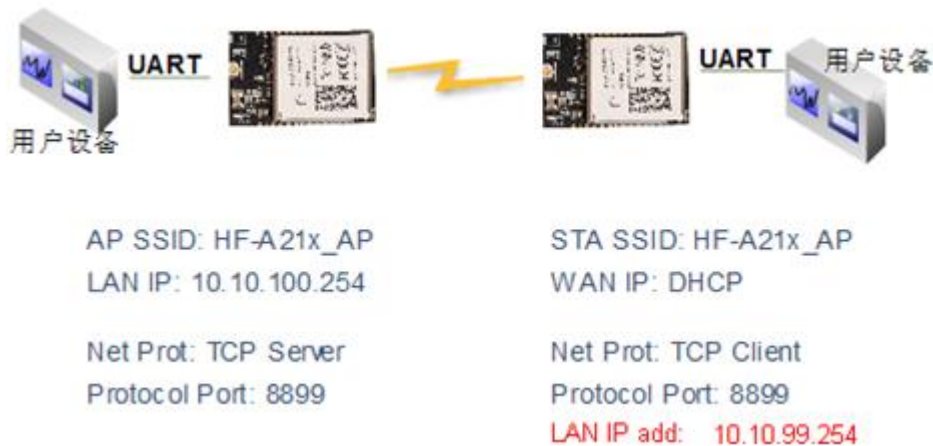

Figure 36. Transparent Serial Port Application

For left side HF-A21-SMT module, configured as AP mode and use default SSID and IP address, network protocol configured as TCP/Server mode, and protocol port ID: 8899.

For right side HF-A21-SMT module, configured as STA mode and setting the same SSID ("HF-A11x_AP" for this example) with left side HF-A21-SMT module, enable DHCP network and network protocol configured as TCP/Client mode, protocol port ID: 8899. Target IP address part setting the same IP address with left side HF-A21-SMT module ("10.10.100.254" for this example).

When right side HF-A21-SMT boot up, it will find wireless AP (SSID: HF-A11x_AP for this example) and open TCP/Client network protocol to connect with left side module's TCP/Server. All these operation will be automatic and after finished, the two user devices connected to HF-A21-SMT module through serial port can communicate each other and think the connection between them is fully transparent.

3.3.4. Wireless Data Acquisition Card Application

For this wireless data acquisition card application, one PC works as data server and every data acquisition card connects with a HF-A21-SMT module to support wireless connection function.

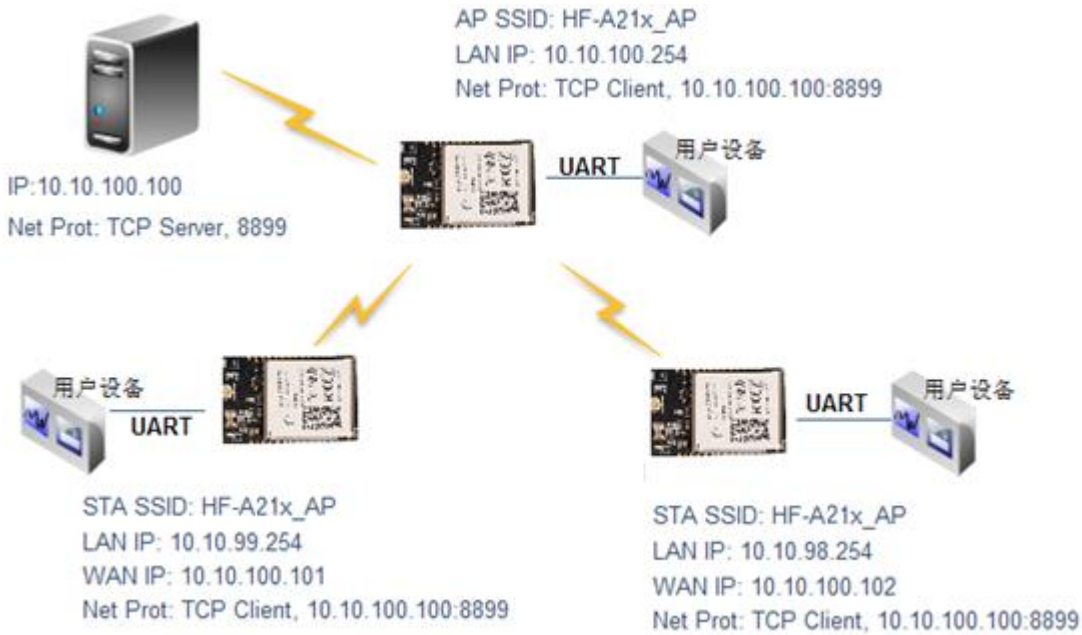

Figure 37. Wireless Data Acquisition Card Application

As above figure, one HF-A21-SMT configured as AP mode and all others configured as STA mode. All HF-A21-SMT which configured as STA and data server PC wireless connected to HF-A21-SMT which configured as AP to make up a wires network.

Data server PC open TCP/Server protocol and all HF-A21-SMT modules open TCP/Client protocol. All data acquisition cards' data and sampling information can be transmitted to data server PC for operation.

4. AT+INSTRUCTION INTRODUCTION

4.1. Configuration Mode

When HF-A21-SMT power up, it will default works as transparent transmission mode, then user can switch to configuration mode by serial port command. HF-A21-SMT UART default parameters setting as below figure,

Uart Setting	
Baudrate	57600
Data Bits	8
Parity	None
Stop	1
CTSRTS	Disable

Figure 38. HF-A21-SMT Default UART Port Parameters

In configuration mode, user can setting the module through AT+ instruction set, which cover all web page setting function.

4.1.1. Switch to Configuration Mode

Two steps to finish switching from transparent transmission mode to configuration mode.

- **UART input “+++”, after module receive “+++”, and feedback “a” as confirmation.**
- **UART input “a”, after module receive “a” and feedback “+ok” to go into AT+ instruction set configuration mode.**

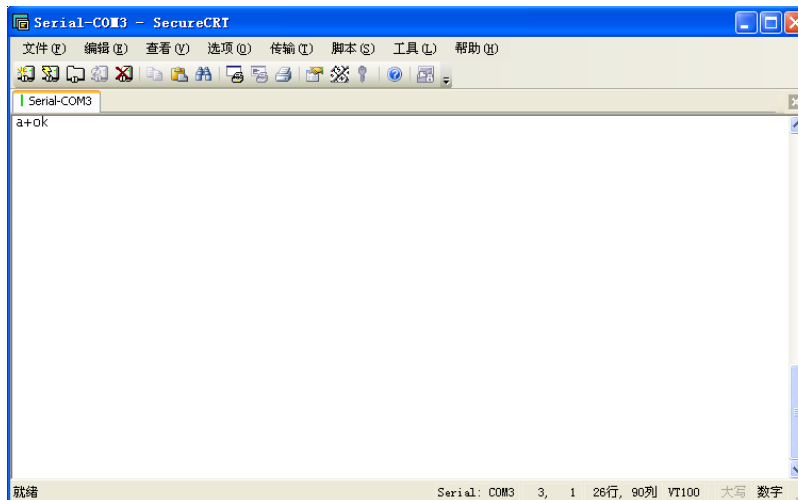

Figure 39. Switch to Configuration Mode

Notes:

1. When user input “+++” (No “Enter” key required), the UART port will display feedback information “a”, and not display input information “+++” as above UART display.
2. Any other input or wrong step to UART port will cause the module still works as original mode (transparent transmission).

4.2. AT+ Instruction Set Overview

User can input AT+ Instruction through hyper terminal or other serial debug terminal, also can program the AT+ Instruction to script. User can also input “AT+H” to list all AT+ Instruction and description to start.

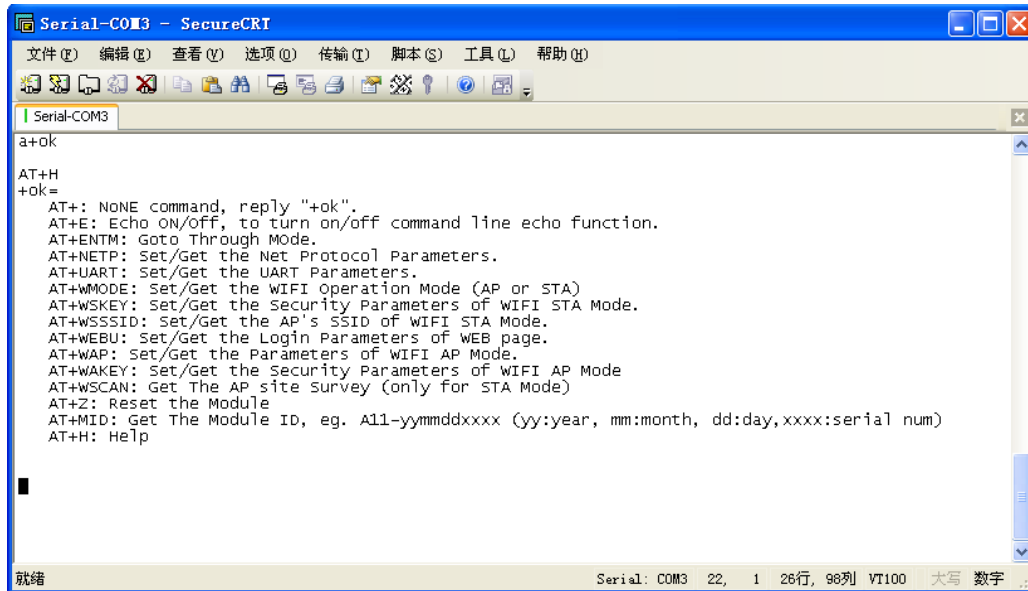

```

Serial-COM3 - SecureCRT
文件(F) 编辑(E) 查看(V) 选项(O) 传输(T) 脚本(S) 工具(L) 帮助(H)
Serial-COM3
a+ok
AT+H
+ok=
AT+: NONE command, reply "+ok".
AT+E: Echo ON/Off, to turn on/off command line echo function.
AT+ENTM: Goto Through Mode.
AT+NETP: Set/Get the Net Protocol Parameters.
AT+UART: Set/Get the UART Parameters.
AT+WMODE: Set/Get the WIFI Operation Mode (AP or STA)
AT+WSKEY: Set/Get the Security Parameters of WIFI STA Mode.
AT+WSSID: Set/Get the AP's SSID of WIFI STA Mode.
AT+WEBU: Set/Get the Login Parameters of WEB page.
AT+WAP: Set/Get the Parameters of WIFI AP Mode.
AT+WKEY: Set/Get the Security Parameters of WIFI AP Mode
AT+WSCAN: Get The AP site survey (only for STA Mode)
AT+Z: Reset the Module
AT+MID: Get The Module ID, eg. A11-yyymmddxxxx (yy:year, mm:month, dd:day,xxxx:serial num)
AT+H: Help
就緒 Serial: COM3 22, 1 26行, 98列 VT100 大写 数字

```

Figure 40. "AT+H" Instruction for Help

4.2.1. Instruction Syntax Format

AT+Instruction protocol is based on the instruction of ASCII command style, the description of syntax format as follow.

- **Format Description**
 - < >: Means the parts must be included
 - []: Means the optional part

- **Command Message**

AT+<CMD>[op][para-1,para-2,para-3,para-4...]<CR>

- AT+: Prefix of command message;
- CMD: Command string;
- [op]: Symbol of command operator,
 - ◆ "=" : The command requires parameters input;
 - ◆ "NULL": Query the current command parameters setting;
- [para-n]: Parameters input for setting if required;
- <CR>: "Enter" Key, it's 0x0a or 0x0d in ASCII;

Notes: When input AT+Instruction, "AT+<CMD>" character will display capital letter automatic and other parts will not change as you input.

- **Response Message**

+<RSP>[op] [para-1,para-2,para-3,para-4...]<CR><LF><CR><LF>

- +: Prefix of response message;
- RSP: Response string;

- ◆ “ok” : Success
- ◆ “ERR”: Failure
- [op] : =
- [para-n]: Parameters if query command or Error code when error happened;
- <CR>: ASCII 0x0d;
- <LF>: ASCII 0x0a;

➤ Error Code

Table 6 Error Code Description HF-A21-SMT Web Access Default Setting

Error Code	Description
-1	Invalid Command Format
-2	Invalid Command
-3	Invalid Operation Symbol
-4	Invalid Parameter
-5	Operation Not Permitted

4.2.2. AT+ Instruction Set

Table 7 AT+ Instruction Set List

Instruction	Description
<null>	NULL
E	Open/Close show back function
ENTM	Set module into transparent transmission mode
NETP	Set/Query network protocol parameters
UART	Set/Query serial port parameters
UARTF	Open/Close UART auto-frame function
UARTFT	Set/Query UART auto-frame trigger time
UARTFL	Set/Query UART auto-frame trigger length
TMODE	Set/Query data transmission mode (transparent transmission)
WMODE	Set/Query WIFI work mode (AP or STA)
WSKEY	Set/Query WIFI security parameters as STA
WSSSID	Set/Query WIFI target AP SSID parameters as STA
WSLK	Query WiFi link status as STA
WEBU	Set/Query WEB page login parameters (User Name and Password)
WAP	Set/Query WIFI parameters as AP
WAKEY	Set/Query WIFI security parameters as AP
HIDESSID	Set/Query hide AP's SSID
MSLP	Set modules into power save mode.(Turn OFF WiFi)
WSCAN	Seek AP when module works as STA mode
TCPLK	Query if TCP link already build-up
TCPDIS	Open/Close TCP (Only TCP Client available)
WANN	Set/Query WAN setting, only effective as STA mode
LANN	Set/Query LAN setting, only effective as AP mode
DHCPDEN	Enable/Disable LAN DHCP server function
DHCPGW	Set/Query DHCP gateway address

TCPTO	Set/Query TCP timeout
MAXSK	Set/Query maxima TCP connection
TCPB	Open/Close TCPB function
TCPPTB	Set/Query TCPB port number
TCPADDB	Set/Query TCPB server address
TCPTOB	Set/Query TCPB time out time
TCPLKB	Query TCPB link status
EPHY	Open/Close ETH interface
STTC	Enable/Disable STA port scan function
DOMAIN	Set/Query domain of module webpage
FRLDEN	Enable/Disable nReload pin function
RELD	Restore to factory default setting
Z	Re-start module
MID	Query module ID information
WRMID	Set module ID
VER	Query module software version information
H	Help
FVEW	Enable/Disable WANN mode
FVER	Set/Query working mode
WMAC	Set/Query AP MAC address
PING	PING command

Notes: HF-A21-SMT module can work as AP or STA, user has to use different AT+ Instruction to set WiFi parameters when module works as AP or STA mode.

4.2.2.1. AT+E

- Function: Open/Close show back function;
- Format:

```
AT+E<CR>  
+ok<CR>< LF ><CR>< LF >
```

When HF-A21-SMT module firstly switch from transparent transmission to configuration mode, show back status is open, input "AT+E" to close show back function, input "AT+E" again to open show back function.

4.2.2.2. AT+ENTM

- Function: Set module into transparent transmission mode;
- Format:

```
AT+ENTM<CR>  
+ok<CR>< LF ><CR>< LF >
```

When operate this command, module switch from configuration mode to transparent transmission mode.

4.2.2.3. AT+NETP

- Function: Set/Query network protocol parameters;
- Format:
 - ◆ Query Operation

```

AT+NETP<CR>
+ok=<protocol,CS,port,IP><CR>< LF ><CR>< LF >
  ◆ Set Operation
AT+NETP=<protocol,CS,port,IP><CR>
+ok<CR>< LF ><CR>< LF >

```

- Parameters:
 - ◆ protocol:
 - ◇ TCP
 - ◇ UDP
 - ◆ CS: Network mode:
 - ◇ SERVER
 - ◇ CLIENT
 - ◆ Port: protocol port ID: Decimal digit and less than 65535
 - ◆ IP: Server's IP address when module set as client

After HF-A21-SMT module boots up again, the setting will be effective.

4.2.2.4. AT+UART

- Function: Set/Query serial port parameters;
- Format:
 - ◆ Query Operation

```

AT+UART<CR>
+ok=<baudrate,data_bits,stop_bit,parity,flowctrl><CR>< LF ><CR>< LF >
  ◆ Set Operation
AT+UART=<baudrate,data_bits,stop_bit,parity><CR>
+ok<CR>< LF ><CR>< LF >

```

- Parameters:
 - ◆ baudrate:
 - ◇ 1200,1800,2400,4800,9600,19200,38400,57600,115200,230400
 - ◆ data_bits:
 - ◇ 5,6,7,8
 - ◆ stop_bits:
 - ◇ 1,2
 - ◆ parity:
 - ◇ NONE,EVEN,ODD,MARK,SPACE
 - ◆ flowctrl: hardware flow control (CTSRTS)
 - ◇ NFC: No flow control
 - ◇ FC: flow control

After HF-A21-SMT module boots up again, the setting will be effective.

4.2.2.5. AT+ UARTF

- Function: Open/Close UART auto-frame function;
- Format:
 - ◆ Query Operation

```

AT+ UARTF<CR>
+ok=<para><CR>< LF ><CR>< LF >
  ◆ Set Operation
AT+ UARTF=<para ><CR>
+ok<CR>< LF ><CR>< LF >

```

- Parameters:
 - ◆ para:
 - ◇ disable - Close auto-frame function;
 - ◇ enable - Open auto-frame function;

4.2.2.6. AT+ UARTFT

- Function: Set/Query UART auto-frame trigger time;
- Format:
 - ◆ Query Operation

```
AT+ UARTFT<CR>
+ok=<time><CR>< LF ><CR>< LF >
```
 - ◆ Set Operation

```
AT+ UARTFT=<time ><CR>
+ok<CR>< LF ><CR>< LF >
```
- Parameters:
 - ◆ time: Range 100 ~10000; Unit: ms. Auto-frame trigger time

4.2.2.7. AT+ UARTFL

- Function: Set/Query UART auto-frame trigger length;
- Format:
 - ◆ Query Operation

```
AT+ UARTFL<CR>
+ok=<len><CR>< LF ><CR>< LF >
```
 - ◆ Set Operation

```
AT+ UARTFL=<len ><CR>
+ok<CR>< LF ><CR>< LF >
```
- Parameters:
 - ◆ len: Range 64 ~4096; Unit: byte. Auto-frame trigger length;

4.2.2.8. AT+TMODE

- Function: Set/Query data transmission mode;
- Format:
 - ◆ Query Operation

```
AT+TMODE<CR>
+ok=<tmode><CR>< LF ><CR>< LF >
```
 - ◆ Set Operation

```
AT+ TMODE=<tmode><CR>
+ok<CR>< LF ><CR>< LF >
```
- Parameters:
 - ◆ tmode: Data transmission
 - ◇ Through: Transparent transmission

After HF-A21-SMT module boots up again, the setting will be effective.

4.2.2.9. AT+WMODE

- Function: Set/Query WIFI work mode;
- Format:
 - ◆ Query Operation

```
AT+WMODE<CR>
+ok=<mode><CR>< LF ><CR>< LF >
```
 - ◆ Set Operation

```
AT+ WMODE=<mode><CR>
+ok<CR>< LF ><CR>< LF >
```
- Parameters:
 - ◆ mode:WIFI work mode
 - ◇ AP
 - ◇ STA

After HF-A21-SMT module boots up again, the setting will be effective.

4.2.2.10. AT+WSKEY

- Function: Set/Query WIFI security parameters as STA;
- Format:
 - ◆ Query Operation

```
AT+WSKEY<CR>
+ok=<auth,encry,key><CR>< LF ><CR>< LF >
```

- ◆ Set Operation

```
AT+ WSKEY=< auth,encry,key><CR>
+ok<CR>< LF ><CR>< LF >
```

- Parameters:
 - ◆ auth: Authentication mode
 - ◇ OPEN
 - ◇ SHARED
 - ◇ WPAPSK
 - ◆ encry:Encryption algorithm
 - ◇ NONE: When “auth=OPEN”, effective
 - ◇ WEP: When “auth=OPEN” or “SHARED”, effective
 - ◇ TKIP: When “auth= WPAPSK”, effective
 - ◇ AES: When “auth= WPAPSK”, effective
 - ◆ key: password, ASCII code, shall less than 64 bit and greater than 8bit

This Instruction only effective for HF-A21-SMT works as STA. After HF-A21-SMT module boots up again, the setting will be effective. But user can set this command when module configured as AP.

4.2.2.11. AT+WSSSID

- Function: Set/Query WIFI target AP SSID parameters as STA.
- Format:
 - ◆ Query Operation

```
AT+WSSSID<CR>
+ok=<ap's ssid><CR>< LF ><CR>< LF >
```

- ◆ Set Operation

```
AT+ WSSSID=<ap's ssid ><CR>
+ok<CR>< LF ><CR>< LF >
```

- Parameters:
 - ◆ ap's ssid: AP's SSID

This Instruction only effective for HF-A21-SMT works as STA. After HF-A21-SMT module boots up again, the setting will be effective. But user can set this command when module configured as AP.

4.2.2.12. AT+ WSLK

- Function: Query WiFi link status as STA
- Format:
 - ◆ Query Operation

```
AT+ WSLK<CR>
+ok=<ret><CR>< LF ><CR>< LF >
```

- Parameters:
 - ◆ ret
 - ◇ "Disconnected", if no WiFi connection;
 - ◇ "AP' SSID (AP's MAC") , if WiFi connection available;
 - ◇ "RF Off", if WiFi OFF;

This Instruction only effective for HF-A21-SMT works as STA. After HF-A21-SMT module boots up again, the setting will be effective. But user can set this command when module configured as AP.

4.2.2.13. AT+WEBU

- Function: Set/Query WEB page login parameters;
- Format:
 - ◆ Query Operation

```
AT+WEBU<CR>
+ok=<usr,password><CR>< LF ><CR>< LF >
```
 - ◆ Set Operation

```
AT+ WEBU=< usr,password ><CR>
+ok<CR>< LF ><CR>< LF >
```
- Parameters:
 - ◆ usr: User name for WEB page access;
 - ◆ password: Password for WEB page access;

4.2.2.14. AT+WAP

- Function: Set/Query WIFI parameters as AP;
- Format:
 - ◆ Query Operation

```
AT+WAP<CR>
+ok=<wifi_mode,ssid,channel><CR>< LF ><CR>< LF >
```
 - ◆ Set Operation

```
AT+ WAP=<wifi_mode,ssid,channel><CR>
+ok<CR>< LF ><CR>< LF >
```
- Parameters:
 - ◆ wifi_mode: WiFi protocols
 - ◇ 11BG
 - ◇ 11B
 - ◇ 11G
 - ◇ 11BGN
 - ◇ 11N
 - ◆ ssid: SSID when module works as AP;
 - ◆ channel: WIFI channel selection
 - ◇ AUTO
 - ◇ CH1~CH11

This Instruction only effective for HF-A21-SMT works as AP. After HF-A21-SMT module boots up again, the setting will be effective. But user can set this command when module configured as STA.

4.2.2.15. AT+WKEY

- Function: Set/Query WIFI security parameters as AP;
- Format:
 - ◆ Query Operation

```
AT+WKEY<CR>
+ok=<auth,encry,key><CR>< LF ><CR>< LF >
```
 - ◆ Set Operation

```
AT+ WKEY=< auth,encry,key><CR>
+ok<CR>< LF ><CR>< LF >
```
- Parameters:
 - ◆ auth: Authentication mode
 - ◇ OPEN
 - ◇ SHARED
 - ◇ WPAPSK
 - ◆ encry:Encryption algorithm
 - ◇ NONE: When “auth=OPEN”, effective;
 - ◇ WEP: When “auth=OPEN”, effective or “SHARED”, effective;

- ◇ TKIP: When “auth=WPAPSK”, effective;
- ◇ AES:When “auth=WPAPSK”, effective;
- ◇ TKIPAES:When “auth=WPAPSK”, effective;
- ◆ key: password, ASCII code, shall less than 64 bit and greater than 8bit;

This Instruction only effective for HF-A21-SMT works as AP. After HF-A21-SMT module boots up again, the setting will be effective. But user can set this command when module configured as STA.

4.2.2.16. AT+HIDESSID

- Function: Set/Query hide AP's SSID;
- Format:
 - ◆ Query Operation
 - AT+ HIDESSID <CR>**
 - +ok=<sta.><CR>< LF ><CR>< LF >**
 - ◆ Set Operation
 - AT+ HIDESSID=<sta><CR>**
 - +ok<CR>< LF ><CR>< LF >**
- Parameters:
 - ◆ When Query,sta reply if module's SSID is hide;
 - ◇ On – not hide SSID;
 - ◇ Off - hide SSID;
 - ◆ When Set,
 - ◇ Off - hide SSID;
 - ◇ On - not hide SSID;

4.2.2.17. AT+MSLP

- Function: Set modules into power save mode.(Turn OFF WiFi);
- Format:
 - ◆ Query Operation
 - AT+ MSLP <CR>**
 - +ok=<sta.><CR>< LF ><CR>< LF >**
 - ◆ Set Operation
 - AT+ MSLP=<on/off><CR>**
 - +ok<CR>< LF ><CR>< LF >**
- Parameters:
 - ◆ When Query,sta reply if the module in sleep mode;
 - ◇ On - Module not in sleep mode (WiFi ON);
 - ◇ Off - Module in sleep mode(WiFi OFF);
 - ◆ When Set,
 - ◇ Off - Set module to sleep mode (WiFi OFF);
 - ◇ On - Set module to normal mode (WiFi ON);

When module go into sleep mode, user can input “AT+MSLP=on” to re-start the module and module go into transparent transmission mode.

4.2.2.18. AT+WSCAN

- Function: Seek AP when module works as STA mode;
- Format:
 - AT+ WSCAN<CR>**
 - +ok=<ap_site><CR>< LF ><CR>< LF >**
- Parameters:
 - ◆ ap_site: AP searched;

4.2.2.19. AT+ TCPLK

- Function: Query if TCP link already build-up;
- Format:

AT+ TCPLK<CR>**+ok=<sta><CR>< LF ><CR>< LF >**

- Parameters:
 - ◆ sta.: if module already setup TCP link;
 - ◇ on: TCP link setup;
 - ◇ off: TCP link not setup;

4.2.2.20. AT + TCPDIS

- Function: Open/Close TCP (Only TCP Client available);
- Format:
 - ◆ Query Operation

AT+TCPDIS<CR>**+ok=<sta><CR>< LF ><CR>< LF >**

- ◆ Set Operation

AT+ TCPDIS=<on/off><CR>**+ok<CR>< LF ><CR>< LF >**

- Parameters:
 - ◆ sta.: set/query TCP link status;
 - ◇ on: TCP link available; When setting “on”, module will connect to TCP server right away.
 - ◇ off: TCP link not available; when setting “off”, module will disconnect with TCP server and not connect again.

4.2.2.21. AT+ WANN

- Function: Set/Query WAN setting, only effective as STA mode;
- Format:
 - ◆ Query Operation

AT+WANN<CR>**+ok=<mode,address,mask,gateway><CR>< LF ><CR>< LF >**

- ◆ Set Operation

AT+ WANN=< mode,address,mask,gateway ><CR>**+ok<CR>< LF ><CR>< LF >**

- Parameters:
 - ◆ mode: IP setting for WAN port
 - ◇ static: Static IP
 - ◇ DHCP: Dynamic IP
 - ◆ address: WAN port IP address;
 - ◆ mask: WAN port subnet mask;
 - ◆ gateway: WAN port gateway address;

This Instruction only effective for HF-A21-SMT works as STA. After HF-A21-SMT module boots up again, the setting will be effective. But user can set this command when module configured as AP.

4.2.2.22. AT+ LANN

- Function: Set/Query LAN setting, only effective as AP mode;
- Format:
 - ◆ Query Operation

AT+LANN<CR>**+ok=<address,mask ><CR>< LF ><CR>< LF >**

- ◆ Set Operation

AT+ LANN=<address,mask ><CR>**+ok<CR>< LF ><CR>< LF >**

- Parameters:
 - ◆ address: LAN port IP address;
 - ◆ mask: LAN port subnet mask;

This Instruction only effective for HF-A21-SMT works as AP. After HF-A21-SMT module boots up again, the setting will be effective. But user can set this command when module configured as STA.

4.2.2.23. AT + DHCPDEN

- Function: Enable/Disable LAN DHCP server function;
- Format:
 - ◆ Query Operation

```
AT+DHCPDEN<CR>
+ok=<sta><CR>< LF ><CR>< LF >
```
 - ◆ Set Operation

```
AT+ DHCPDEN=<sat><CR>
+ok<CR>< LF ><CR>< LF >
```
- Parameters:
 - ◆ sta. if Enable/Disable LAN DHCP server function;
 - ◇ on: Enable LAN DHCP server function.
 - ◇ off: Disable LAN DHCP server function.

4.2.2.24. AT+ DHCPGW

- Function: Set/Query DHCP gateway address;
- Format:
 - ◆ Query Operation

```
AT+ DHCPGW<CR>
+ok=<address><CR>< LF ><CR>< LF >
```
 - ◆ Set Operation

```
AT+ DHCPGW=<address ><CR>
+ok<CR>< LF ><CR>< LF >
```
- Parameters:
 - ◆ address: DHCP gate address;

4.2.2.25. AT+ TCPTO

- Function: Set/Query TCP timeout;
- Format:
 - ◆ Query Operation

```
AT+ TCPTO<CR>
+ok=<time><CR>< LF ><CR>< LF >
```
 - ◆ Set Operation

```
AT+ TCPTO=<time ><CR>
+ok<CR>< LF ><CR>< LF >
```
- Parameters:
 - ◆ time: TCP timeout time.
 - ◇ <= 600, (600s);
 - ◇ >=0, (0 means no timeout);
 - ◇ Default, 300s;

4.2.2.26. AT+ MAXSK

- Function: Set/Query maxima TCP connection;
- Format:
 - ◆ Query Operation

```
AT+ MAXSK<CR>
+ok=<num><CR>< LF ><CR>< LF >
```
 - ◆ Set Operation

```
AT+ MAXSK =<num ><CR>
+ok<CR>< LF ><CR>< LF >
```
- Parameters:

- ◆ num: 1~32, default 32. maxima TCP connection;

When configure as TCP/Server, HF-A21-SMT support maxime 32 TCP connections. If not require so much connection, user can resetting this parameters.

4.2.2.27. AT+TCPB

- Function: Open/Close TCPB function;
- Format:
 - ◆ Query Operation

```
AT+TCPB<CR>
+ok=<sta><CR>< LF ><CR>< LF >
```
 - ◆ Set Operation

```
AT+ TCPB=<on/off><CR>
+ok<CR>< LF ><CR>< LF >
```
- Parameters:
 - ◆ sta: TCPB enable status
 - ◇ on, TCPB enable
 - ◇ off, TCPB disable

After HF-A21-SMT module boots up again, the setting will be effective.

4.2.2.28. AT+TCPPTB

- Function: Set/Query TCPB port number;
- Format:
 - ◆ Query Operation

```
AT+TCPPTB<CR>
+ok=<port><CR>< LF ><CR>< LF >
```
 - ◆ Set Operation

```
AT+ TCPB=<port><CR>
+ok<CR>< LF ><CR>< LF >
```
- Parameters:
 - ◆ port: decimal ,<65535

After HF-A21-SMT module boots up again, the setting will be effective.

4.2.2.29. AT+TCPADDB

- Function: Set/Query TCPB server address;
- Format:
 - ◆ Query Operation

```
AT+TCPADDB<CR>
+ok=<add><CR>< LF ><CR>< LF >
```
 - ◆ Set Operation

```
AT+ TCPADDB=<add><CR>
+ok<CR>< LF ><CR>< LF >
```
- Parameters:
 - ◆ add: TCPB server address, can be IP address or url.

After HF-A21-SMT module boots up again, the setting will be effective

4.2.2.30. AT+TCPTOB

- Function: Set/Query TCPB time out time;
- Format:
 - ◆ Query Operation

```
AT+TCPTOB<CR>
+ok=<time><CR>< LF ><CR>< LF >
```
 - ◆ Set Operation

```
AT+ TCPTOB=<time><CR>
+ok<CR>< LF ><CR>< LF >
```

- Parameters:

- ◆ time: TCPB time out time, <=600 (600s), >=0 (No time out), default 300

After HF-A21-SMT module boots up again, the setting will be effective.

4.2.2.31. AT+TCPLKB

- Function: Query TCPB link status;

- Format:

```
AT+TCPCKB<CR>
+ok=<sta><CR>< LF ><CR>< LF >
```

- Parameters:

- ◆ sta: TCPB link status
 - ◇ on, TCPB link OK
 - ◇ off, TCPB link not available

4.2.2.32. AT+EPHY

- Function: Enable ETH interface;

- Format:

- ◆ Set Operation

```
AT+ EPHY=<CR>
+ok<CR>< LF ><CR>< LF >
```

Ethernet port function is disabled by default. Input this command to enable Ethernet. This command is not saved, this means after the module reset, Ethernet is disabled by default. Input "AT+FEPHY=on" to enable Ethernet forever..

4.2.2.33. AT+STTC

- Function: Enable/Disable STA port scan function;

- Format:

- ◆ Query Operation

```
AT+ STTC<CR>
+ok=<sta><CR>< LF ><CR>< LF >
```

- ◆ Set Operation

```
AT+ STTC=<on/off><CR>
+ok<CR>< LF ><CR>< LF >
```

- Parameters:

- ◆ sta: when query, this value feedback
 - ◇ On: Enable STA port scan function;
 - ◇ Off: Disable STA port scan function;

4.2.2.34. AT+DOMAIN

- Function: Set/Query domain of module webpage;

- Format:

- ◆ Query Operation

```
AT+ DOMAIN<CR>
+ok=<domain><CR>< LF ><CR>< LF >
```

- ◆ Set Operation

```
AT+ DOMAIN=<domain><CR>
+ok<CR>< LF ><CR>< LF >
```

- Parameters:

- ◇ domain: domain to access to module webpage.

4.2.2.35. AT+FRLDEN

- Function: Enable/Disable nReload pin function;

- Format:

- ◆ Query Operation

AT+ FRLDEN<CR>
+ok=< on/off ><CR>< LF ><CR>< LF >
 ◆ Set Operation

AT+ FRLDEN=<on/off><CR>
+ok<CR>< LF ><CR>< LF >

- Parameters:
 - ◆ on/off: Enable or Disable nReload pin function.
 - ◇ On, enable nReload pin function;
 - ◇ Off, disable nReload pin function;

Notes: AT+FRLDEN is F-Setting, means restore to factory setting will not affect this command.

4.2.2.36. AT+RELD

- Function: Restore to factory default setting;
- Format:

AT+ RELD<CR>
+ok=rebooting...<CR>< LF ><CR>< LF >

This command restores the module to factory default setting, and then re-starts the module.

4.2.2.37. AT+Z

- Function: Re-start module;
- Format:

AT+ Z<CR>

4.2.2.38. AT+MID

- Function: Query module ID information;
- Format:
 - ◆ Query Operation

AT+MID<CR>
+ok=<module_id><CR><LF><CR><LF>

- Parameters:
 - ◆ module_id: Module ID information;

4.2.2.39. AT+WRMID

- Function: Set module ID information;
- Format:
 - ◆ Set Operation

AT+WRMID=<module_id><CR>
+ok<CR><LF><CR><LF>

- Parameters:
 - ◆ module_id: Module ID information;

4.2.2.40. AT+VER

- Function: Query module software version information;
- Format:
 - ◆ Query Operation

AT+VER<CR>
+ok=<ver><CR><LF><CR><LF>

- Parameters:
 - ◆ ver: Module software version information;

4.2.2.41. AT+H

- Function: Help;
- Format:

- ◆ Query Operation

```
AT+H<CR>
+ok=<commod help><CR><LF><CR><LF>
```

- Parameters:
 - ◆ commod help: command introduction;

4.2.2.42. AT+FVEW

- Function: Enable/Disable Ethernet WANN mode. It's valid only if restore to factory setting.;
- Format:

- ◆ Query Operation

```
AT+ FVEW<CR>
+ok=<status><CR><LF><CR><LF>
```

- ◆ Set Operation

```
AT+ FVEW=<status><CR>
+ok<CR><LF><CR><LF>
```

- Parameters:
 - ◆ status: Enable or Disable Ethernet WANN mode..
 - ◇ enable, enable Ethernet WANN mode;
 - ◇ disable, disable Ethernet WANN mode, then it works in Ethernet LANN mode.**(default mode)**

If Ethernet WANN mode is valid. Then wireless connecting router in STA mode is invalid. It only support connecting to router by Ethernet..

4.2.2.43. AT+FVER

- Function: Set/Query module working mode;
- Format:

- ◆ Query Operation

```
AT+ FVER<CR>
+ok=<status><CR><LF><CR><LF>
```

- ◆ Set Operation

```
AT+ FVER=<n/z><CR>
+ok<CR><LF><CR><LF>
```

- Parameters:
 - ◆ status: module working mode..
 - ◇ n: router mode.(default mode)
 - ◇ z: bridge mode.

4.2.2.44. AT+WMAC

- Function: Set/Query module MAC address;
- Format:

- ◆ Query Operation

```
AT+ WMAC<CR>
+ok=<address><CR><LF><CR><LF>
```

- ◆ Set Operation

```
AT+ WMAC=<address><CR>
+ok<CR><LF><CR><LF>
```

- Parameters:
 - ◆ address: module MAC address in AP mode.

The module's STA MAC address is AP's MAC address plus 1. For example, AP address: ACCF23208888, then STA address: ACCF23208889.

4.2.2.45. AT+PING

- Function: PING command;
- Format:

- ◆ Set Operation

AT+ PING=<address><CR>

+ok=<status><CR><LF><CR><LF>

- Parameters:

- ◆ address: target IP address.
- ◆ Status:command result.

5. PACKAGE INFORMATION

5.1 Shipping Information

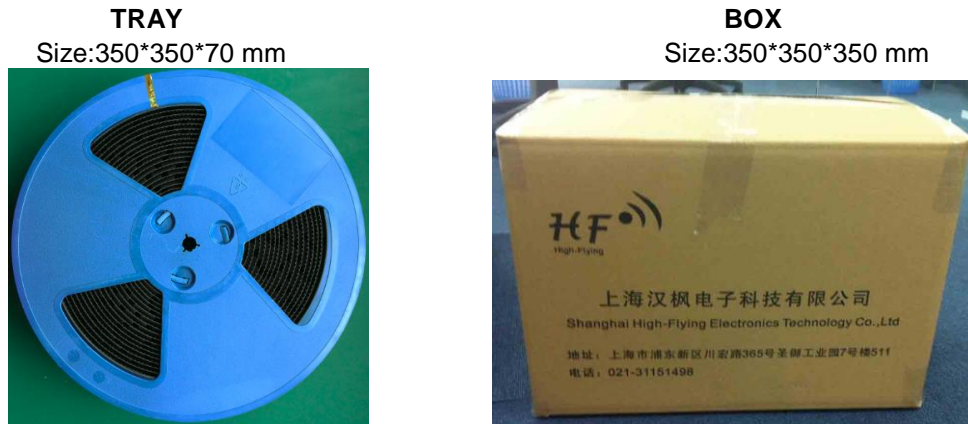

Figure 41. Shipping Information

Note:

1 tray = 500 pcs

1 box = 5 trays = 5 * 100 pcs = 2500pcs

APPENDIX A: QUESTIONS AND ANSWERS

Q1: How to configure transparent serial port application (TCP protocol) with two HF-A21-SMT modules?

- Network structure as below figure:
 - Module 1# Setting:
 - ✧ Works as AP mode; --See "Mode Selection Page"
 - ✧ LAN IP address: 10.10.100.254; --See "AP Interface Setting Page"
 - ✧ Network Protocol:TCP/Server, Port ID: 8899; -- See "Application Setting Page"
(Module default setting);
 - Module 2# Setting:
 - ✧ Works as STA mode; --See "Mode Selection Page"
 - ✧ WAN connection type: DHCP or Static IP (For this example:10.10.100.100) --See "STA Interface Setting Page"
 - ✧ Network Protocol:TCP/Client, Port ID: 8899; Application IP address: Module 1#'s LAN IP address (10.10.100.254); -- See "Application Setting Page"
 - ✧ **Notes:** When module 2# works as STA mode, module's WiFi interface works as WAN port. Module's WAN IP address and LAN IP address shall be setting different segment. So, module 2#'s LAN IP address must change to other segment; (For this sample, we change to 10.10.99.254); --See "AP Interface Setting Page"

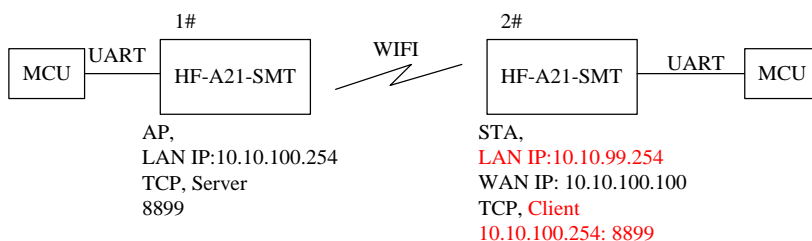

Figure 42. Configure Transparent Serial Port Connection (TCP)

Q2: Where to Set HF-A21-SMT Module LAN IP and WAN IP through Web Page?

- HF-A21-SMT Wireless LAN IP address setting see "AP Interface Setting Page" as below Figure,

LAN Setup	
IP Address	10.10.100.254
Subnet Mask	255.255.255.0
MAC Address	88:8B:5D:70:04:87
DHCP Type	Server
Default DHCP Gateway	10.10.100.254
<input type="button" value="Apply"/> <input type="button" value="Cancel"/>	

Figure 43. Module LAN IP Setting

- HF-A21-SMT Wireless WAN IP address setting see “STA Interface Setting Page” as below Figure, User can set WAN connection type to DHCP and STATIC IP.

WAN Connection Type: STATIC (fixed IP) ▾

Static Mode	
IP Address	10.10.99.254
Subnet Mask	255.255.0.0
Default Gateway	10.10.99.254

Figure 44. Module WAN IP Setting

Q3: How to configure transparent serial port application (UDP protocol) with two HF-A21-SMT modules?

- Network structure as below figure:
 - Module 1# Setting:
 - ✧ Works as AP mode; --See “Mode Selection Page”
 - ✧ LAN IP address: 10.10.100.254; --See “AP Interface Setting Page”
 - ✧ Network Protocol:UDP, Port ID: 8899; Application IP address:10.10.100.100; -- See “Application Setting Page”
 - Module 2# Setting:
 - ✧ Works as STA mode; --See “Mode Selection Page”
 - ✧ WAN connection type: Static IP (10.10.100.100) --See “STA Interface Setting Page”
 - ✧ Network Protocol:UDP, Port ID: 8899; Application IP address: Module 1#'s LAN IP address (10.10.100.254); -- See “Application Setting Page”
 - ✧ LAN IP address: 10.10.99.254 (Different net segment with WAN port) --See “AP Interface Setting Page”

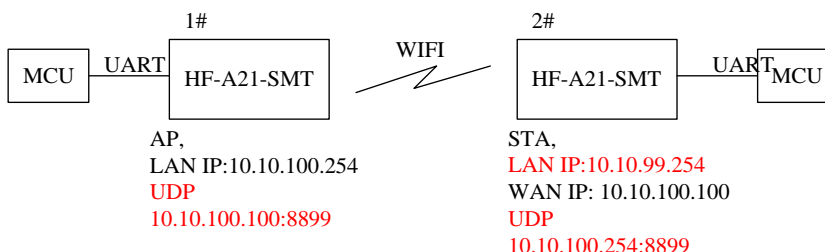

Figure 45. Configure Transparent Serial Port Connection (UDP)

Q4: Where to set HF-A21-SMT module network protocol (TCP/UDP)?

- HF-A21-SMT network protocol setting see “Application Setting Page” as below Figure,

- Protocol: TCP Server
 - ◇ Only Port ID required: 8899 (Default)

Net Setting	
Mode	Server
Protocol	TCP
Port	8899
IP Address	10.10.10.100
TCP Time out (MAX 600 s)	300

Figure 46. Module Network Protocols: TCP/Server

- Protocol: TCP Client
 - ◇ Application IP address required: it's target TCP server 's IP address;
 - ◇ Port ID required: 8899 (Default)

Net Setting	
Mode	Client
Protocol	TCP
Port	8899
IP Address	10.10.10.100
TCP Time out (MAX 600 s)	300

Figure 47. Module Network Protocol: TCP/Client

- Protocol: UDP
 - ◇ No Server/Client selection required;
 - ◇ Application IP address required: it's target device 's IP address;
 - ◇ Port ID required: 8899 (Default)

Net Setting	
Mode	Client
Protocol	UDP
Port	8899
IP Address	10.10.10.100

Figure 48. Module Network Protocol: UDP

Q5: How to configure transparent serial port application: Two HF-A21-SMT modules all configured as STA and connection through AP?

- Network structure as below figure:
 - Module 1# Setting: (We use HF-A21-SMT as AP for this example)

- ◇ Works as AP mode and all default setting;
- Module 2# Setting:
 - ◇ Works as STA mode; --See “Mode Selection Page”
 - ◇ WAN connection type: Static IP: 10.10.100.100; --See “STA Interface Setting Page”
 - ◇ Network Protocol:TCP/Server, Port ID: 8899; -- See “Application Setting Page”
 - ◇ LAN IP address: 10.10.99.254 (Different net segment with WAN port); --See “AP Interface Setting Page”
- Module 3# Setting:
 - ◇ Works as STA mode; --See “Mode Selection Page”
 - ◇ WAN connection type: Static IP: 10.10.100.101; --See “STA Interface Setting Page”
 - ◇ Network Protocol:TCP/Client, Port ID: 8899; Application IP address: Module 2#'s WAN IP address (10.10.100.100); -- See “Application Setting Page”
 - ◇ LAN IP address: 10.10.98.254 (Different net segment with WAN port); --See “AP Interface Setting Page”

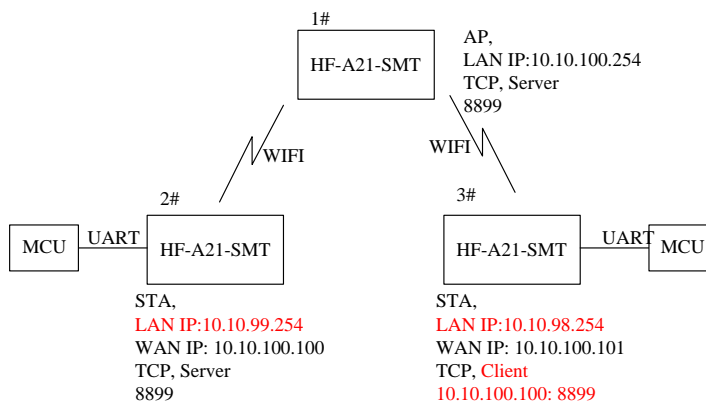

Figure 49. Two HF-A21-SMT Modules Connection Through AP

Q6: How to avoid IP address conflict when apply HF-A21-SMT module?

- The following address allocation method can avoid the IP address conflict for dynamic and static IP address mixed application.
 - Module dynamic IP address range from 100 to 200 for last IP address segment.
 - ◇ Such as default IP: 10.10.100.254. When module works as AP, the IP address module can allocate to STA is from 10.10.100.100 to 10.10.100.200;
 - So, if user needs to set static IP for dedicated STA internal network, the available IP address range can start from 10.10.100.1 to 10.10.100.99.

Q7: PC works as server, all HF-A21-SMT modules works as data acquisition card and connect with PC, how to configure this application?

- Network structure as below figure: Three HF-A21-SMT module setup 3 TCP links with PC server. Module 1# works as AP and all devices connect to module 1# through WiFi interface;
 - PC Setting:
 - ◇ IP address: 10.10.100.100;

- ✧ Network Protocol:TCP/Server, Port ID: 8899;
- Module 1# Setting:
 - ✧ Works as AP mode;
 - ✧ LAN IP address: 10.10.100.254;
 - ✧ Network Protocol:TCP/Client, Port ID: 8899; Application IP address:10.10.100.100;
- Module 2# Setting:
 - ✧ Works as STA mode;
 - ✧ WAN connection type: Static IP: 10.10.100.101;
 - ✧ Network Protocol:TCP/Client, Port ID: 8899; Application IP address:10.10.100.100;
 - ✧ LAN IP address: 10.10.99.254 (Different net segment with WAN port);
- Module 3# Setting:
 - ✧ Works as STA mode;
 - ✧ WAN connection type: Static IP: 10.10.100.102;
 - ✧ Network Protocol:TCP/Client, Port ID: 8899; Application IP address:10.10.100.100;
 - ✧ LAN IP address: 10.10.98.254 (Different net segment with WAN port);

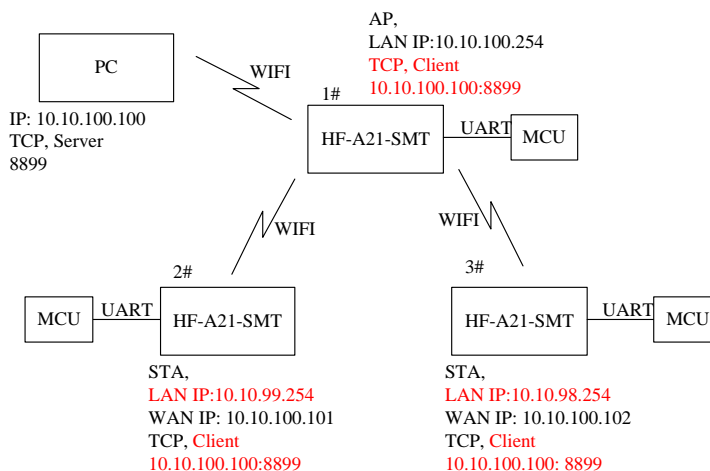
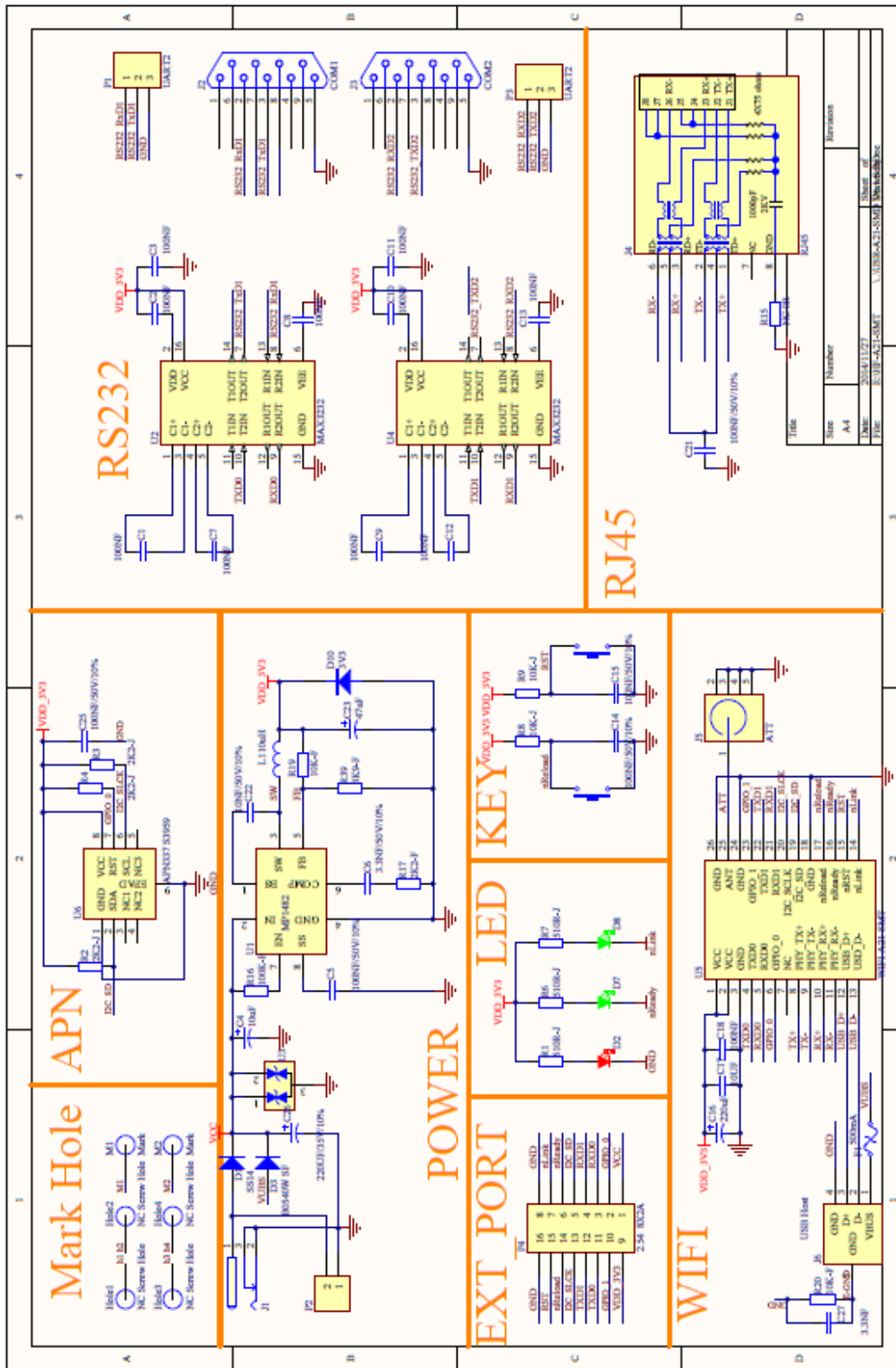

Figure 50. Wireless Data Acquisition Card Setting

APPENDIX B: EVB REFERENCE DESIGN



APPENDIX C: CONTACT INFORMATION

Address: Room 1002,Building 1,No.3000,Longdong Avenue,Pudong New Area,Shanghai,China, 201203

Web: www.hi-flying.com

Service Online: 400-189-3108

Mail Contact: sales@hi-flying.com

END OF DOCUMENT

© Copyright High-Flying, May, 2011

The information disclosed herein is proprietary to High-Flying and is not to be used by or disclosed to unauthorized persons without the written consent of High-Flying. The recipient of this document shall respect the security status of the information. The master of this document is stored on an electronic database and is “write-protected” and may be altered only by authorized persons at High-Flying. Viewing of the master document electronically on electronic database ensures access to the current issue. Any other copies must be regarded as uncontrolled copies.