

OLED C click™

1. Introduction

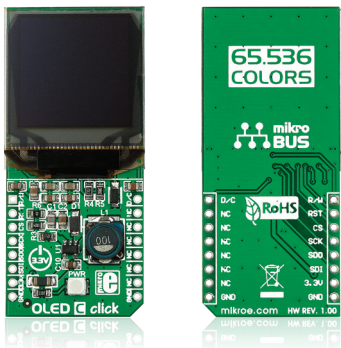

OLED C click™ lets you add a small but bright and crisp color display to your design. It carries a passive matrix OLED (PMOLED) display capable of displaying over **65k colors**, and a **SEPS114A** display driver and controller IC. OLED C click™ communicates with the target board through **mikroBUS™** SPI lines: CS, SCK, and MOSI (SDI); and AN (R/W), PWM (A/C) and RST lines. OLED C click™ is designed to use a 3.3V power supply only. Small displays like these are ideal for displaying color icons, txt or images.

2. Soldering the headers

Before using your click™ board, make sure to solder 1x8 male headers to both left and right side of the board. Two 1x8 male headers are included with the board in the package.

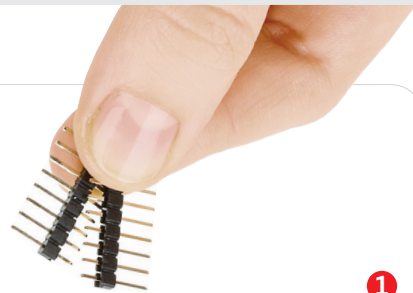

1

2

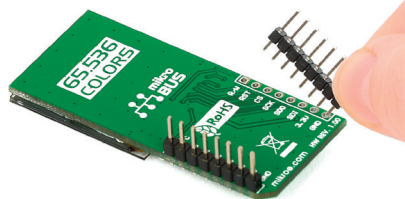

Turn the board upside down so that the bottom side is facing you upwards. Place shorter pins of the header into the appropriate soldering pads.

3

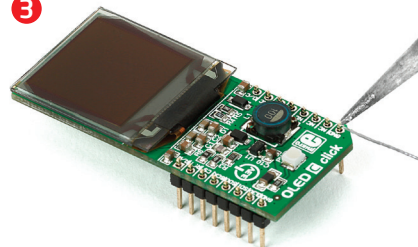

Turn the board upward again. Make sure to align the headers so that they are perpendicular to the board, then solder the pins carefully.

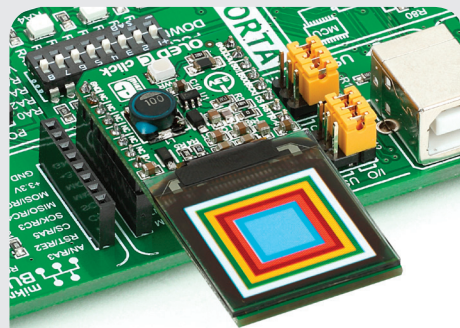

4. Essential features

OLED displays are made from a thin film of organic compound that emits light when exposed to a current. They are bright, have a wide viewing angle and low power consumption (20mA maximum). The display on OLED C click™ is 19.8 x 19.8mm with a 96 x 96px resolution. The SEPS114A controller has built-in functionalities like screen saver (vertical scroll, horizontal panning, fade in/out), programmable panel size, power save mode and so forth.

3. Plugging the board in

Once you have soldered the headers your board is ready to be placed into the desired mikroBUS™ socket. Make sure to align the cut in the lower-right part of the board with the markings on the silkscreen at the mikroBUS™ socket. If all the pins are aligned correctly, push the board all the way into the socket.

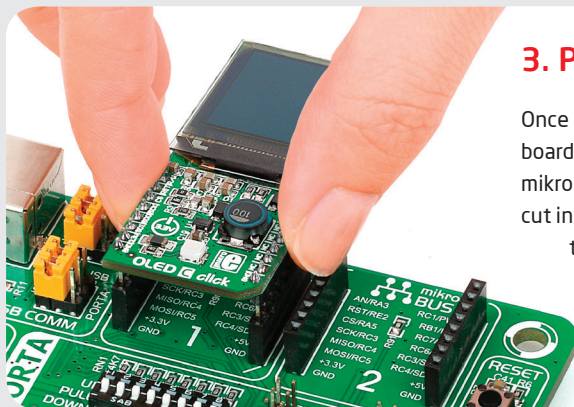

click™
BOARD
www.mikroe.com

OLED C click Manual v1.00



0 100000 027097

5. OLED C click™ board schematic

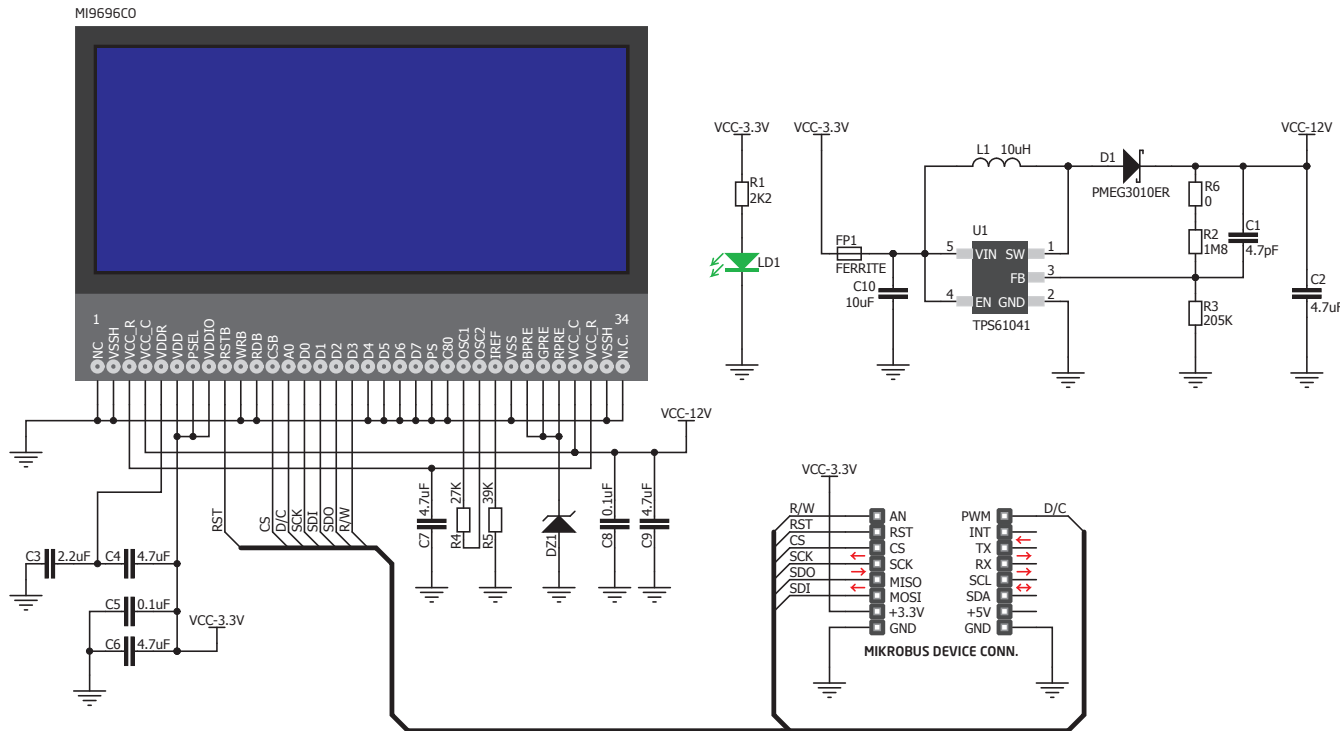

MikroElektronika assumes no responsibility or liability for any errors or inaccuracies that may appear in the present document. Specification and information contained in the present schematic are subject to change at any time without notice. Copyright © 2014 MikroElektronika. All rights reserved.

6. Choose your OLED

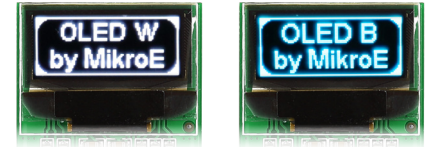

We have two more click™ boards with OLED displays. For details about other two, the monochromatic OLED W and OLED B clicks, visit: www.mikroe.com/click

7. Code examples

Once you have done all the necessary preparations, it's time to get your click™ board up and running. We have provided examples for mikroC™, mikroBasic™ and mikroPascal™ compilers on our **Libstock** website. Just download them and you are ready to start.



8. Support

MikroElektronika offers **free tech support** (www.mikroe.com/support) until the end of the product's lifetime, so if something goes wrong, we're ready and willing to help!

