

PLCC Series

3030 1W UE CRI70

Datasheet

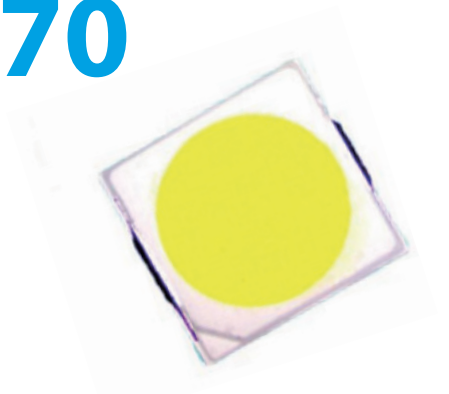

Street Light



Flood Light



High Bay

Introduction :

EMC 3030 6V is a surface-mount LED which uses standard package dimension of 3.0 x 3.2 x 0.6mm, enabling drop-in replacement for existing 3030 packages. Besides, EMC package is heat-resistant and especially suitable for high power applications. 3030 6V Series comes in all ANSI CCTs and delivers the efficacy and reliability required for outdoor street light applications.

Description :

- Industry standard compatible 3.0mmx3.2mm package
- Wide viewing angle : 120°
- Enables 3, 5 step MacAdam ellipse kits
- CRI (Ra) min. 70
- Typ. Luminous flux : 160 lm @ 4000K

Feature and Benefits :

- High luminous Flux and high efficiency
- Based on Blue : InGaN technology
- Excellent performance and visibility
- Suitable for all SMT assembly methods
- IR reflow process compatible
- Environmental friendly; RoHS compliance
- ANSI Compliant color binning

Table of Contents

General Information	3
Absolute Maximum Ratings (Ta=25°C).....	4
Characteristics	4
Luminous Flux Characteristic.....	5
Voltage Bin Structure	6
Mechanical Dimensions.....	7
Color BIN code.....	8
Characteristic curve	12
Reflow Profile	17
Reliability	18
Product Packaging information	19
Revision History	20
About Edison Opto	20

General Information

[NEW] Ordering Code Format

2 T 1 2 0 1 x W A 7 0 0 6 x x x
 X1 X2 X3-X4 X5-X6 X7-X8 X9 X10-X11 X12-X13 X14-X16

X1		X2		X3-X4		X5-X6		X7-X8	
Type		Component		Series		Wattage		Color/CCT	
2	Emitter	T	PLCC	12	3030	01	1W	65	6500K
								57	5700K
								50	5000K
								40	4000K
								35	3500K
								30	3000K
								27	2700K

X9		X10-X11		X12-X13		X14-X16	
BIN		CRI		Voltage		Serial Number	
A	ANSI	70	CRI (Ra) 70	06	6V	-	-

Absolute Maximum Ratings (Ta=25°C)

Parameter	Symbol	Value	Units
Forward Current	I_F	200	mA
Pulse Forward Current (tp≤100μs, Duty cycle=0.25)	I_{pulse}	400	mA
Reverse Current	I_R	10	uA
Reverse Voltage	V_R	-	V
LED Junction Temperature	T_J	125	°C
Operating Temperature	-	-40 ~ +85	°C
Storage Temperature	-	-40 ~ +125	°C
ESD Sensitivity (HBM)	V_B	2,000	V
Soldering Temperature	T_s	Reflow Soldering : 255~260°C/10~30sec Manual Soldering : 350°C/3sec	

Notes:

1. Proper current derating must be observed to maintain junction temperature below the maximum at all time.
2. LEDs are not designed to be driven in reverse bias.

Characteristics

Parameter	Symbol	Value	Units
Viewing Angle (Typ.)	$2\theta_{1/2}$	120	Degree
Thermal resistance	-	10	°C/W
CRI(Ra)	-	70	-
CCT (Cool White) (Neutral White) (Warm White)	-	6500	K
		5700	
		5000	
		4000	
		3500	
		3000 2700	
JEDEC Moisture Sensitivity	-	Level 2a Floor Life Conditions: ≤30°C / 60% RH Soak Requirements(Standard) Time (hours): 120+1/-0 Conditions: 60°C / 60% RH	

Notes:

1. $2\theta_{1/2}$ is the off-axis angle where the luminous intensity is half of the axial luminous intensity.
2. Color Rendering index CRI tolerance: ±2.
3. CIE x/y tolerance: ±0.005

Luminous Flux Characteristic

Luminous Flux Characteristics, $I_f=150\text{mA}$ and $T_j=25^\circ\text{C}$

Color	CRI (Ra)	Group	Min. Luminous flux (lm)	Max. Luminous flux (lm)	Forward Current (mA)	Order Code
6500K	70	V4	140	150	150	2T120165A7006004
		V5	150	160		
V5		150	160	2T120157A7006004		
W1		160	180			
5000K		V5	150	160		2T120150A7006004
		W1	160	180		
4000K		V5	150	160		2T120140A7006004
		W1	160	180		
3500K		V4	140	150		2T120135A7006004
		V5	150	160		
3000K	V4	140	150	2T120130A7006004		
	V5	150	160			
2700K	V3	130	140	2T120127A7006004		
	V4	140	150			

Note:

The luminous flux performance is guaranteed within published operating conditions. Edison Opto maintains a tolerance of $\pm 10\%$ on flux measurements.

Voltage Bin Structure

Group	Min. Voltage (V)	Max. Voltage (V)
U58	5.8	6.0
U60	6.0	6.2
U62	6.2	6.4

Note:
Forward voltage measurement allowance is $\pm 0.06V$.

Mechanical Dimensions

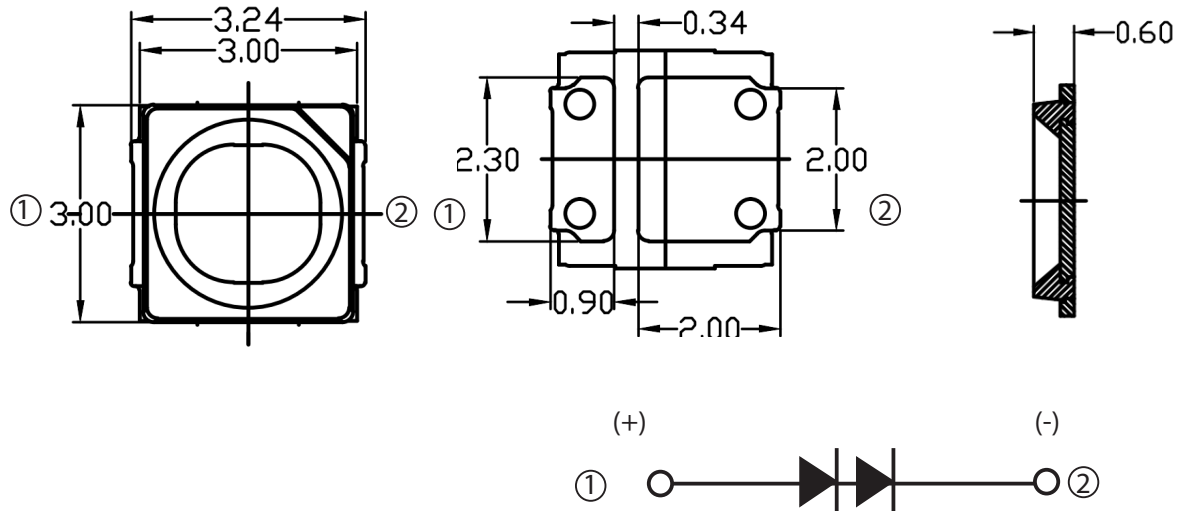

Solder Pad

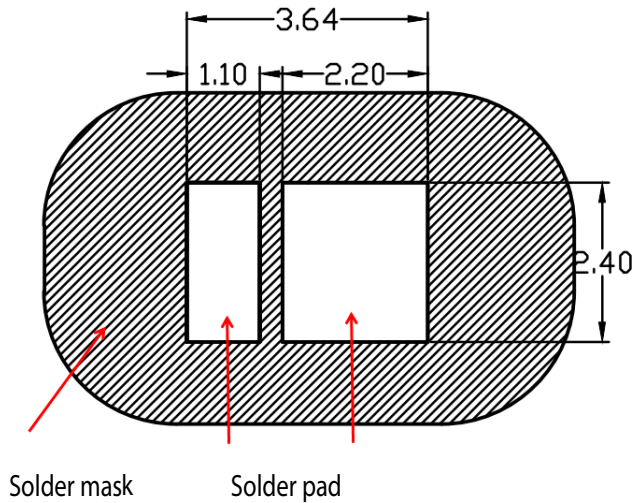

Notes:

1. All dimensions are measured in mm.
2. Tolerance : ± 0.20 mm

Color BIN code

Color region stay within Macadam "3-Step/5-step" ellipse from the chromaticity center.
The chromaticity center refers to ANSI C78.377:2008.
Please refer to ANSI C78.377 for the chromaticity center.

CCT	Steps	Cx	Cy	a	b	theta
2700K	5	0.4578	0.4101	0.01350	0.00700	53.70
3000K	5	0.4338	0.4030	0.01390	0.00680	53.22
3500K	5	0.4073	0.3917	0.01545	0.00690	54.00
4000K	5	0.3818	0.3797	0.01565	0.00670	53.72
5000K	5	0.3447	0.3553	0.01370	0.00590	59.62
5700K	5	0.3287	0.3417	0.01243	0.00533	59.09
6500K	5	0.3123	0.3282	0.01115	0.00475	58.57

CCT	Steps	Cx	Cy	a	b	theta
2700K	3	0.4578	0.4101	0.00810	0.00420	53.70
3000K	3	0.4338	0.4030	0.00834	0.00408	53.22
3500K	3	0.4073	0.3917	0.00927	0.00414	54.00
4000K	3	0.3818	0.3797	0.00939	0.00402	53.72
5000K	3	0.3447	0.3553	0.00822	0.00354	59.62
5700K	3	0.3287	0.3417	0.00746	0.00320	59.09
6500K	3	0.3123	0.3282	0.00669	0.00285	58.57

Cool White

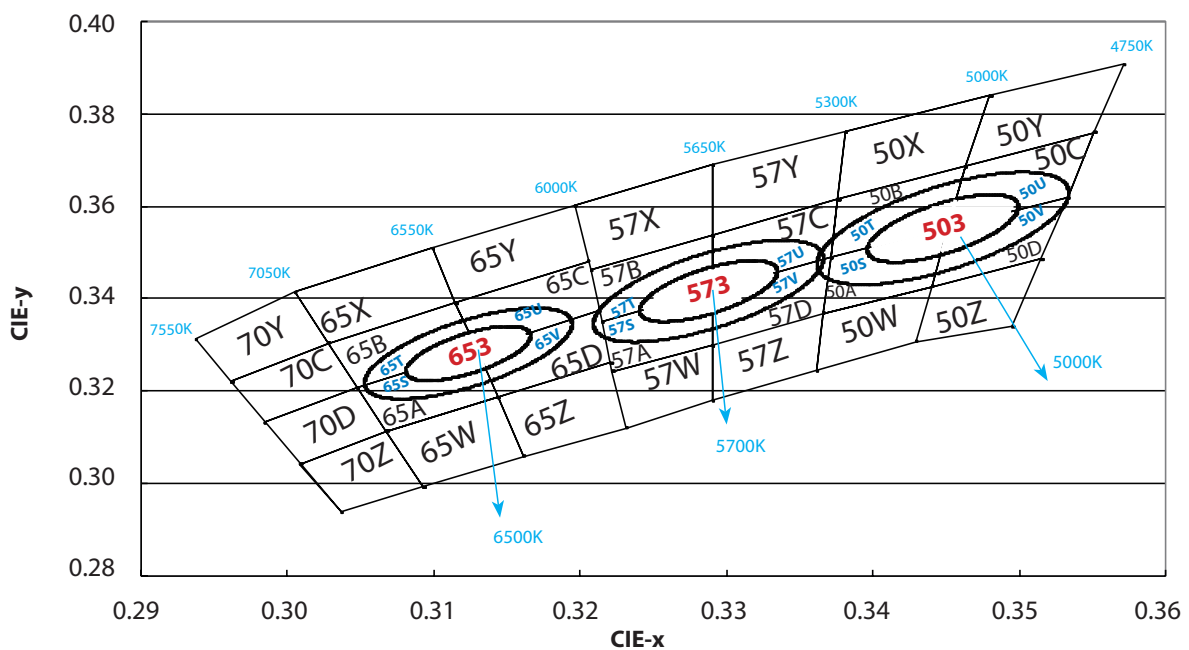

Neutral White

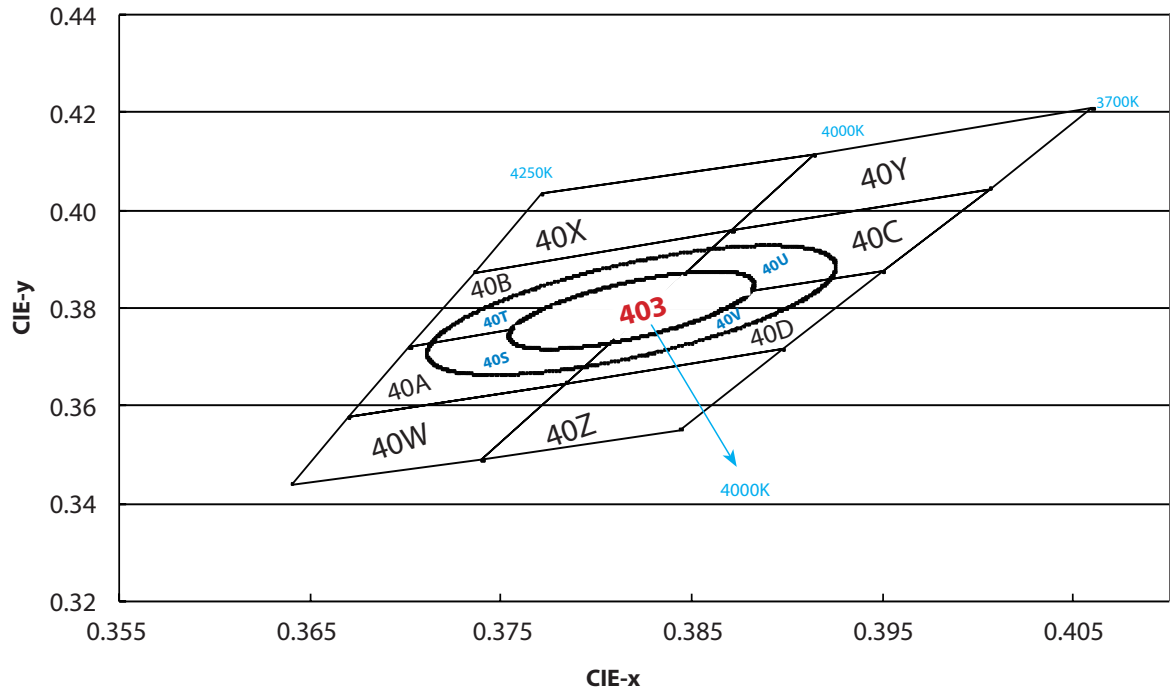

Warm White

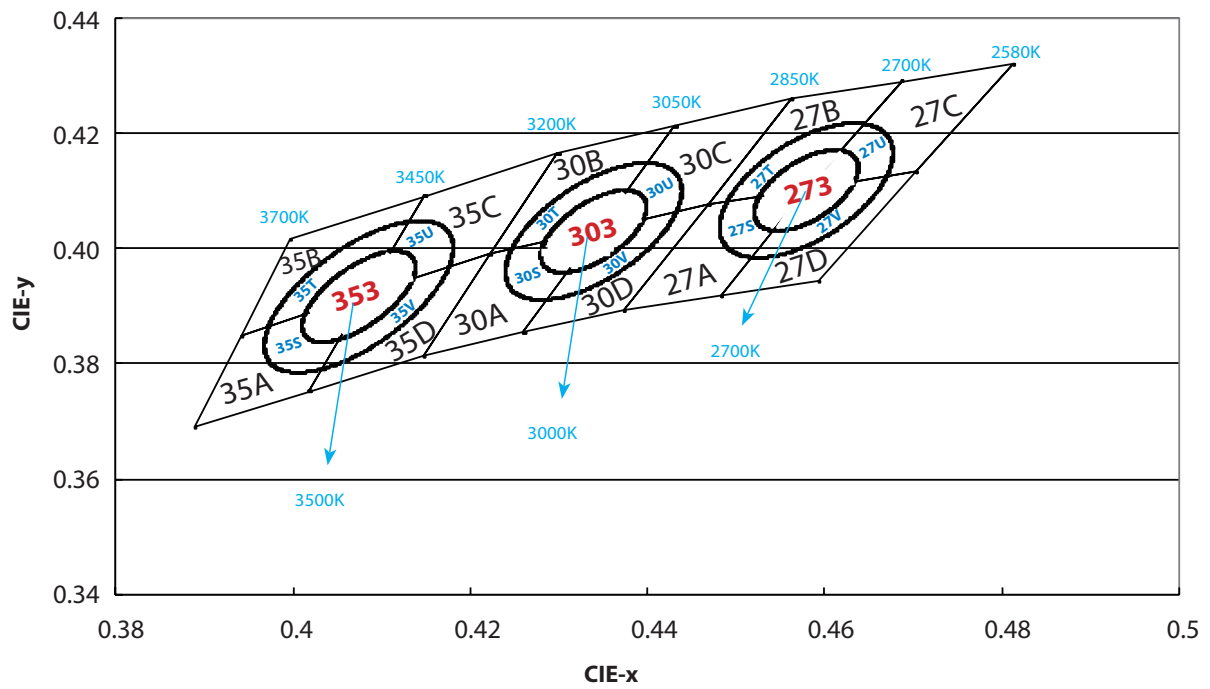

6500K

65X		65B		65A		65W	
X	Y	X	Y	X	Y	X	Y
0.3005	0.3415	0.3115	0.3391	0.3130	0.3290	0.3068	0.3113
0.3099	0.3509	0.3028	0.3304	0.3048	0.3207	0.3144	0.3186
0.3115	0.3391	0.3048	0.3207	0.3068	0.3113	0.3161	0.3059
0.3028	0.3304	0.3130	0.3290	0.3144	0.3186	0.3093	0.2993

65Y		65C		65D		65Z	
X	Y	X	Y	X	Y	X	Y
0.3099	0.3509	0.3205	0.3481	0.3213	0.3373	0.3144	0.3186
0.3196	0.3602	0.3115	0.3391	0.3130	0.3290	0.3221	0.3261
0.3205	0.3481	0.3130	0.3290	0.3144	0.3186	0.3231	0.3120
0.3115	0.3391	0.3213	0.3373	0.3221	0.3261	0.3161	0.3059

5700K

57X		57B		57A		57W	
X	Y	X	Y	X	Y	X	Y
0.3196	0.3602	0.3290	0.3538	0.3290	0.3417	0.3222	0.3243
0.3290	0.3690	0.3207	0.3462	0.3215	0.3350	0.3290	0.3300
0.3290	0.3538	0.3215	0.3350	0.3222	0.3243	0.3290	0.3180
0.3207	0.3462	0.3290	0.3417	0.3290	0.3300	0.3231	0.3120

57Y		57C		57D		57Z	
X	Y	X	Y	X	Y	X	Y
0.3290	0.3690	0.3376	0.3616	0.3371	0.3490	0.3290	0.3300
0.3381	0.3762	0.3290	0.3538	0.3290	0.3417	0.3366	0.3369
0.3376	0.3616	0.3290	0.3417	0.3290	0.3300	0.3361	0.3245
0.3290	0.3538	0.3371	0.3490	0.3366	0.3369	0.3290	0.3180

5000K

50X		50B		50A		50W	
X	Y	X	Y	X	Y	X	Y
0.3381	0.3762	0.3463	0.3687	0.3451	0.3554	0.3366	0.3369
0.3480	0.3840	0.3376	0.3616	0.3371	0.3490	0.3440	0.3427
0.3463	0.3687	0.3371	0.3490	0.3366	0.3369	0.3429	0.3307
0.3376	0.3616	0.3451	0.3554	0.3440	0.3427	0.3361	0.3245

50Y		50C		50D		50Z	
X	Y	X	Y	X	Y	X	Y
0.3480	0.3840	0.3551	0.3760	0.3533	0.3620	0.3440	0.3427
0.3571	0.3907	0.3463	0.3687	0.3451	0.3554	0.3515	0.3487
0.3551	0.3760	0.3451	0.3554	0.3440	0.3427	0.3495	0.3339
0.3463	0.3687	0.3533	0.3620	0.3515	0.3487	0.3429	0.3307

4000K

40X		40B		40A		40W	
X	Y	X	Y	X	Y	X	Y
0.3771	0.4034	0.3871	0.3959	0.3828	0.3803	0.3670	0.3578
0.3736	0.3874	0.3736	0.3874	0.3702	0.3722	0.3640	0.3440
0.3871	0.3959	0.3702	0.3722	0.3670	0.3578	0.3740	0.3491
0.3914	0.4115	0.3828	0.3803	0.3784	0.3647	0.3784	0.3647

40Y		40C		40D		40Z	
X	Y	X	Y	X	Y	X	Y
0.3914	0.4115	0.4006	0.4044	0.3950	0.3875	0.3784	0.3647
0.3871	0.3959	0.3871	0.3959	0.3828	0.3803	0.3740	0.3491
0.4006	0.4044	0.3828	0.3803	0.3784	0.3647	0.3844	0.3552
0.4060	0.4208	0.3950	0.3875	0.3898	0.3716	0.3898	0.3716

3500K

35A		35B		35C		35D	
X	Y	X	Y	X	Y	X	Y
0.4083	0.3921	0.4148	0.4090	0.4299	0.4165	0.4223	0.399
0.3941	0.3848	0.3996	0.4015	0.4148	0.4090	0.4083	0.3921
0.3889	0.3690	0.3941	0.3848	0.4083	0.3921	0.4018	0.3752
0.4018	0.3752	0.4083	0.3921	0.4223	0.399	0.4147	0.3814

3000K

30A		30B		30C		30D	
X	Y	X	Y	X	Y	X	Y
0.4345	0.4033	0.4431	0.4213	0.4562	0.4260	0.4468	0.4077
0.4223	0.3990	0.4299	0.4165	0.4431	0.4213	0.4345	0.4033
0.4147	0.3814	0.4223	0.3990	0.4345	0.4033	0.4260	0.3854
0.4260	0.3854	0.4345	0.4033	0.4468	0.4077	0.4373	0.3893

2700K

27A		27B		27C		27D	
X	Y	X	Y	X	Y	X	Y
0.4578	0.4101	0.4687	0.4289	0.4813	0.4319	0.4703	0.4132
0.4468	0.4077	0.4562	0.4260	0.4687	0.4289	0.4578	0.4101
0.4373	0.3893	0.4468	0.4077	0.4578	0.4101	0.4483	0.3919
0.4483	0.3919	0.4578	0.4101	0.4703	0.4132	0.4593	0.3944

Characteristic curve

Color Spectrum <CRI (Ra) 70>

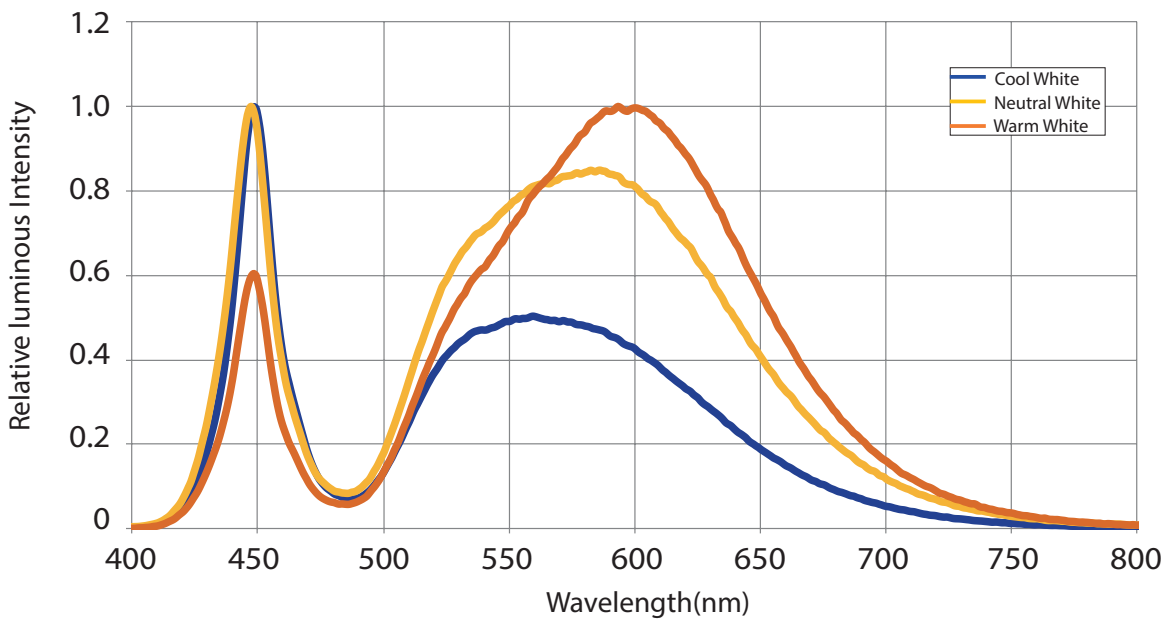

Beam Pattern

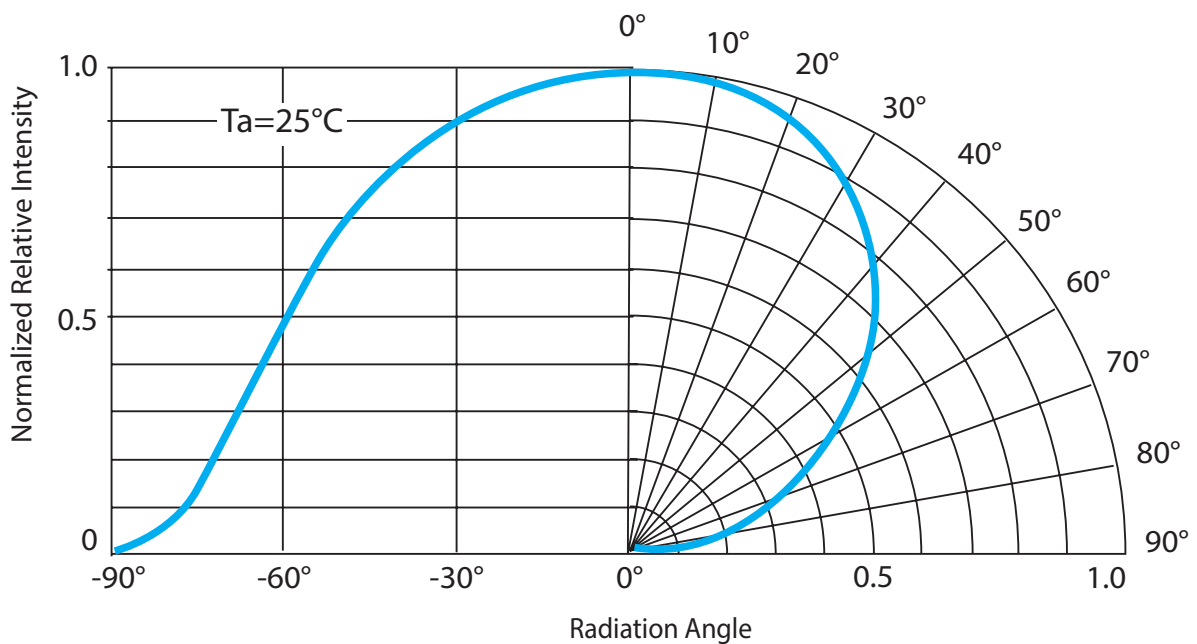

Forward Current vs. Forward Voltage

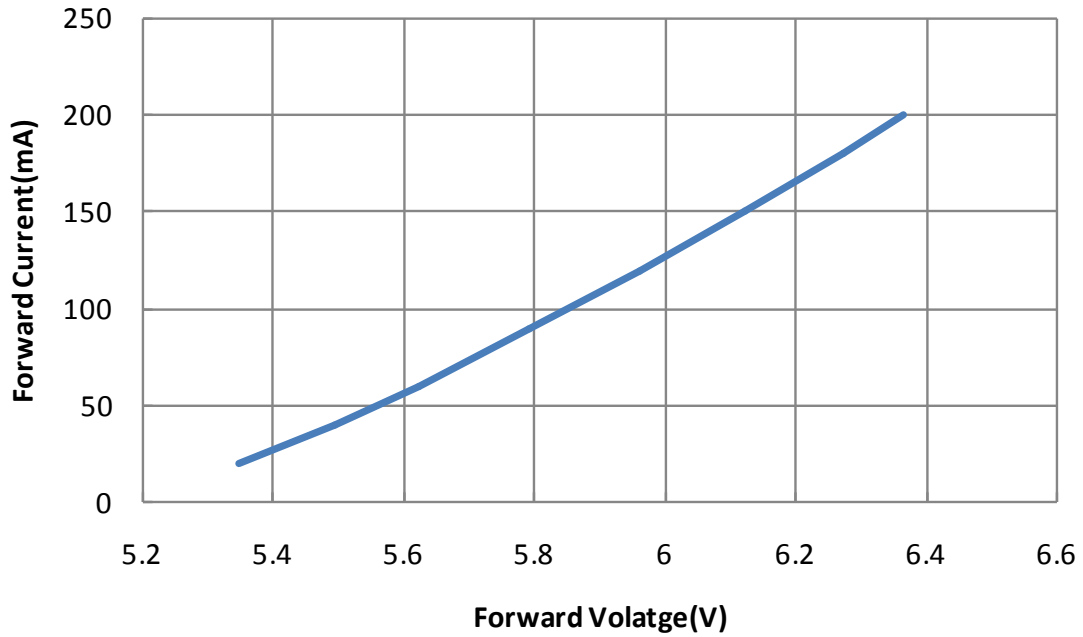

Relative Luminous flux vs. Forward Current

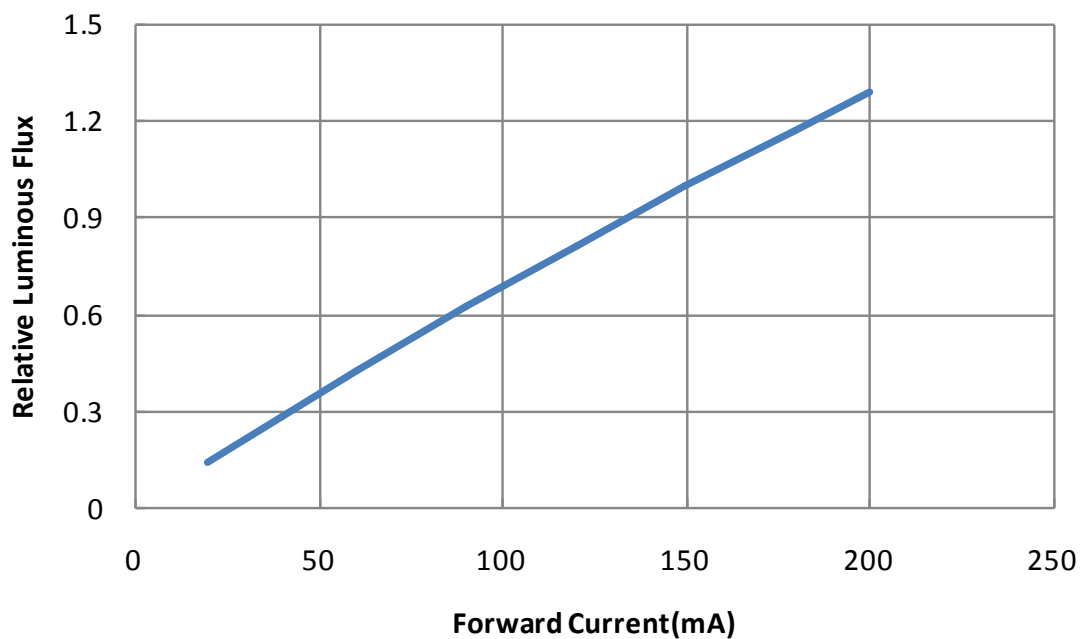

Relative Luminous Flux vs. Junction Temperature

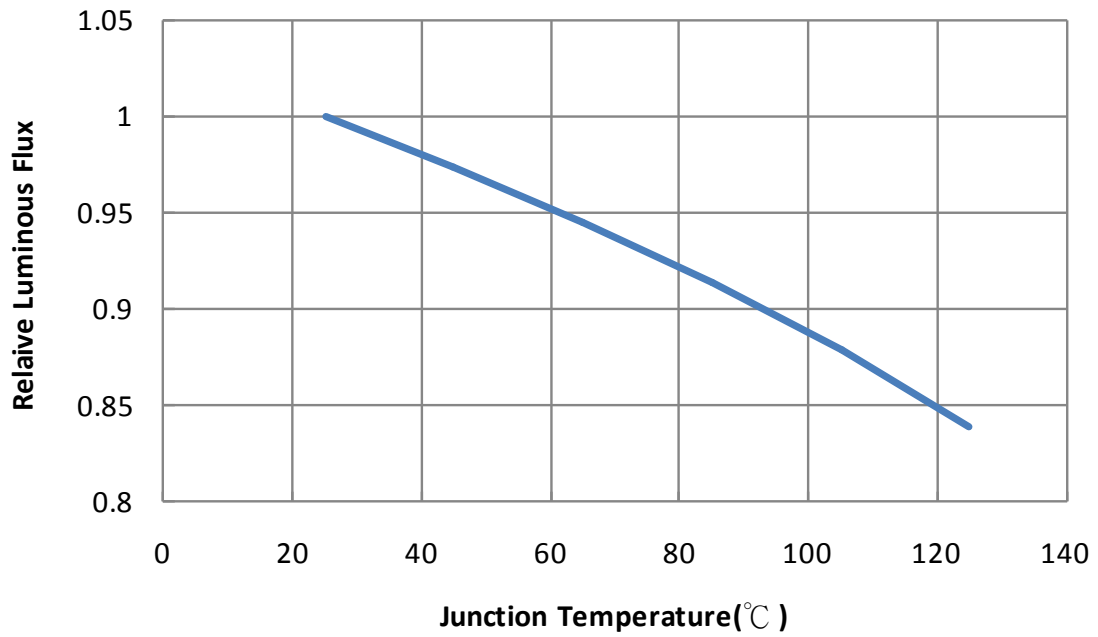

Forward Voltage vs. Junction Temperature

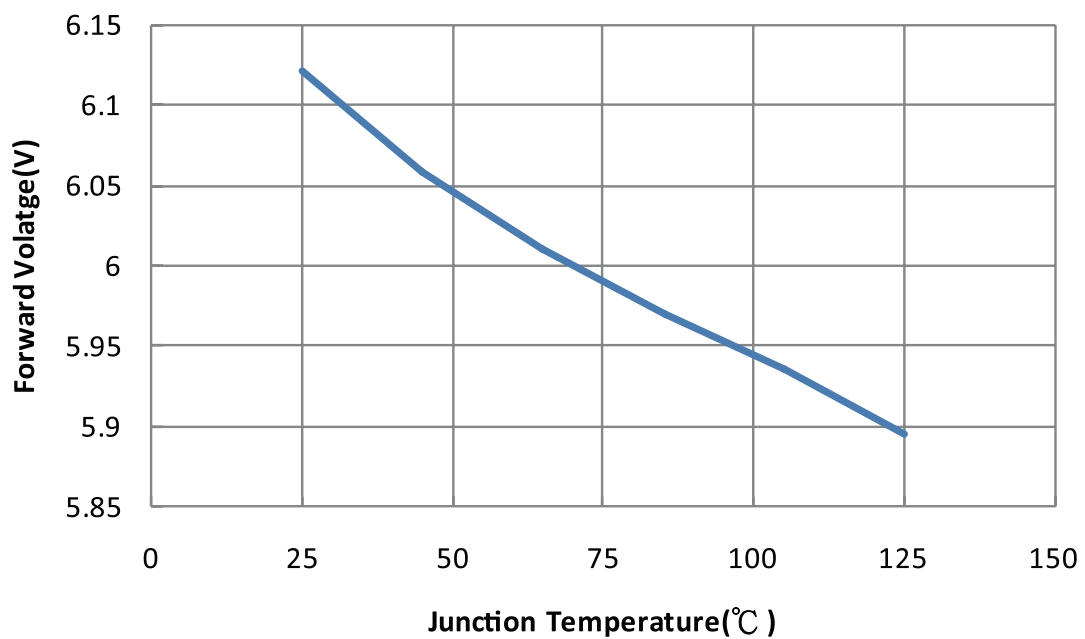

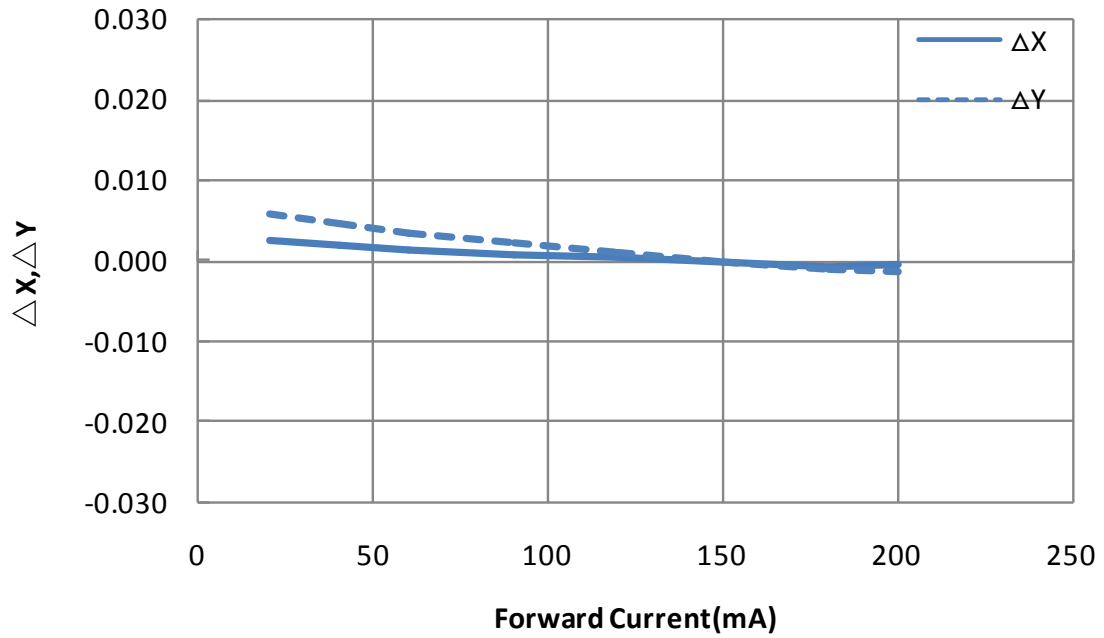

Δx,Δy vs. Junction Temperature

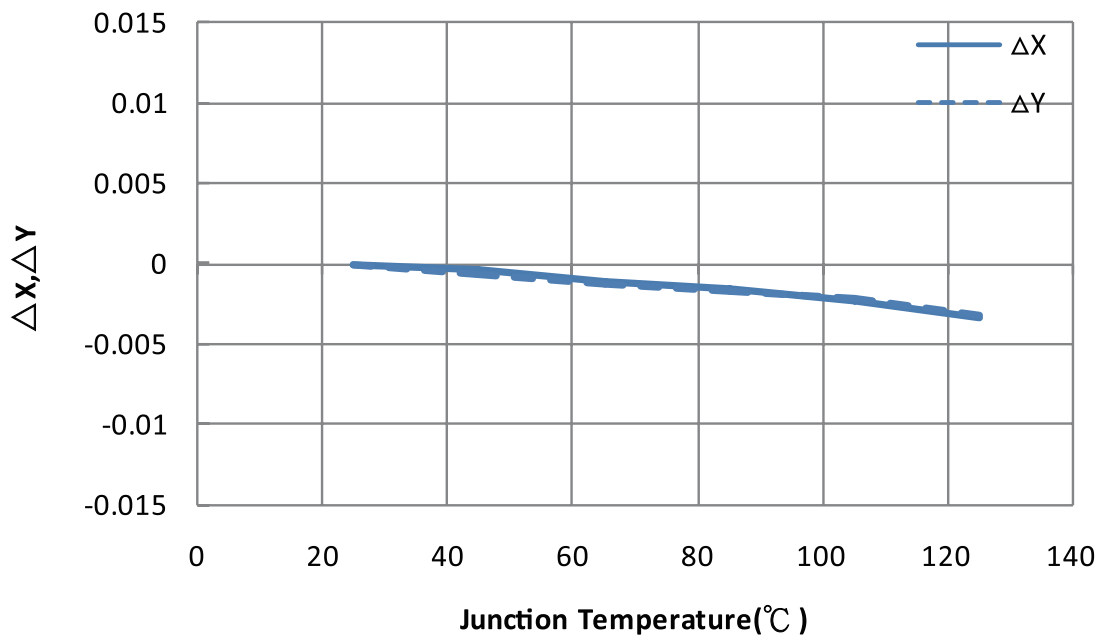

Maximum Current vs. Solder Pad Temperature

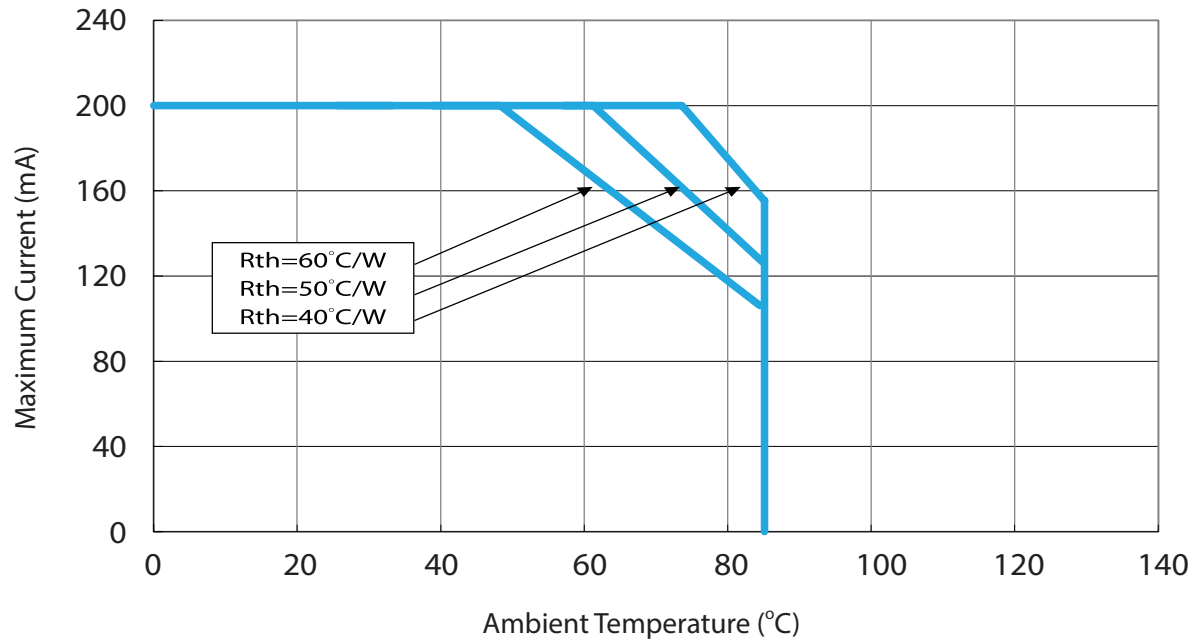

Reflow Profile

The following reflow profile is from IPC/JEDEC J-STD-020D which provided here for reference.

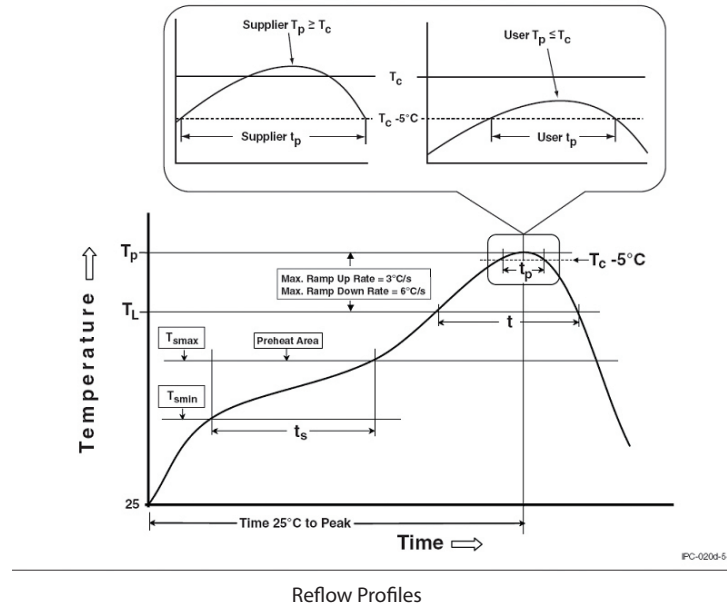

Reflow Profiles

Classification Reflow Profiles

Profile Feature	Pb-Free Assembly
Preheat & Soak Temperature min (T_{smin}) Temperature max (T_{smx}) Time (T_{smin} to T_{smx}) (t_s)	150 °C 200 °C 60-120 seconds
Average ramp-up rate (T_{smx} to T_p)	3 °C/second max.
Liquidous temperature (T_L) Time at liquidous (t_L)	217 °C 60-150 seconds
Peak package body temperature (T_p)*	255 °C ~260 °C *
Classification temperature (T_c)	260 °C
Time (t_p)** within 5 °C of the specified classification temperature (T_c)	30** seconds
Average ramp-down rate (T_p to T_{smx})	6°C/second max.
Time 25°C to peak temperature	8 minutes max.

Notes:

- * Tolerance for peak profile temperature (T_p) is defined as a supplier minimum and a user maximum.
- ** Tolerance for time at peak profile temperature (t_p) is defined as a supplier minimum and a user maximum.

Reliability

NO .	Test Item	Test Condition	Remark
1	Temperature Cycle	-40°C~100°C 30, 30, mins	100 Cycle
2	Thermal Shock	-40°C~100°C 15, 15 mins \leq 10 sec	100 Cycle
3	Resistance to Soldering Heat	T _{SOL} =260°C, 30 sec	3 times
4	Moisture Resistance	25°C~65°C 90% RH 24 hrs / 1 cycle	10 Cycle
5	High-Temperature Storage	T _A =100°C	1,000 hrs
6	Low-Temperature Storage	T _A =-40°C	1,000 hrs
7	Operation Life test	25°C	1,000 hrs
8	High Temperature Operation Life test	85°C	1,000 hrs
9	High Humidity Heat Life Test	60°C, 90%RH	1,000 hrs
10	ON/OFF Test	30 sec ON, 30 sec OFF	1.5W times

Failure Criteria

Item	Criteria for Judgment	
	Min.	Max.
Lumen Maintenance	85%	-
$\Delta u'v'$	-	0.006
Forward Voltage	-	Initial Data x 1.1
Reverse Current	-	10 μ A
Resistance to Soldering Heat	No dead lamps or visual damage	

Cautions

LEDs should be stored or lighted in the environment of no sulfur.

Some materials, such as plastic seals, printing ink, enclosures and adhesives, may contain sulfur.

LEDs also should not be exposed in the acid or halogen environment.

Product Packaging information

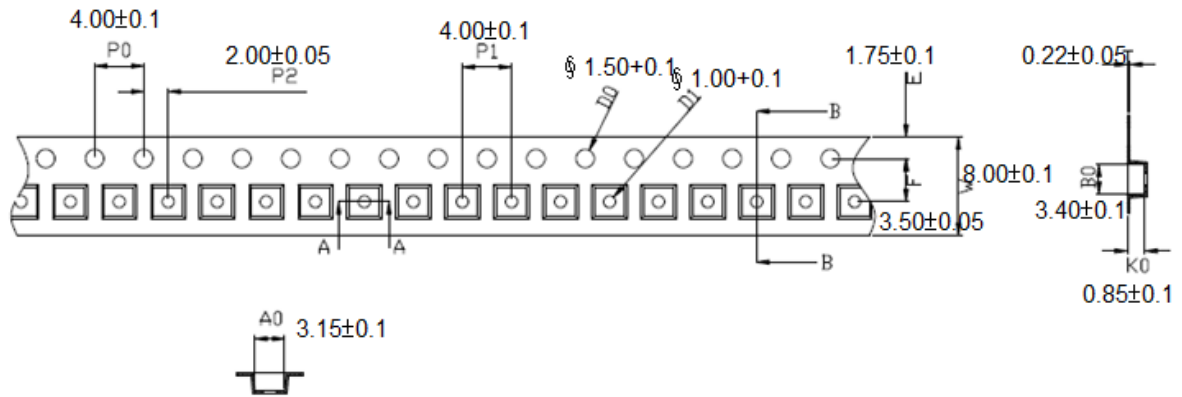

Reel Specification

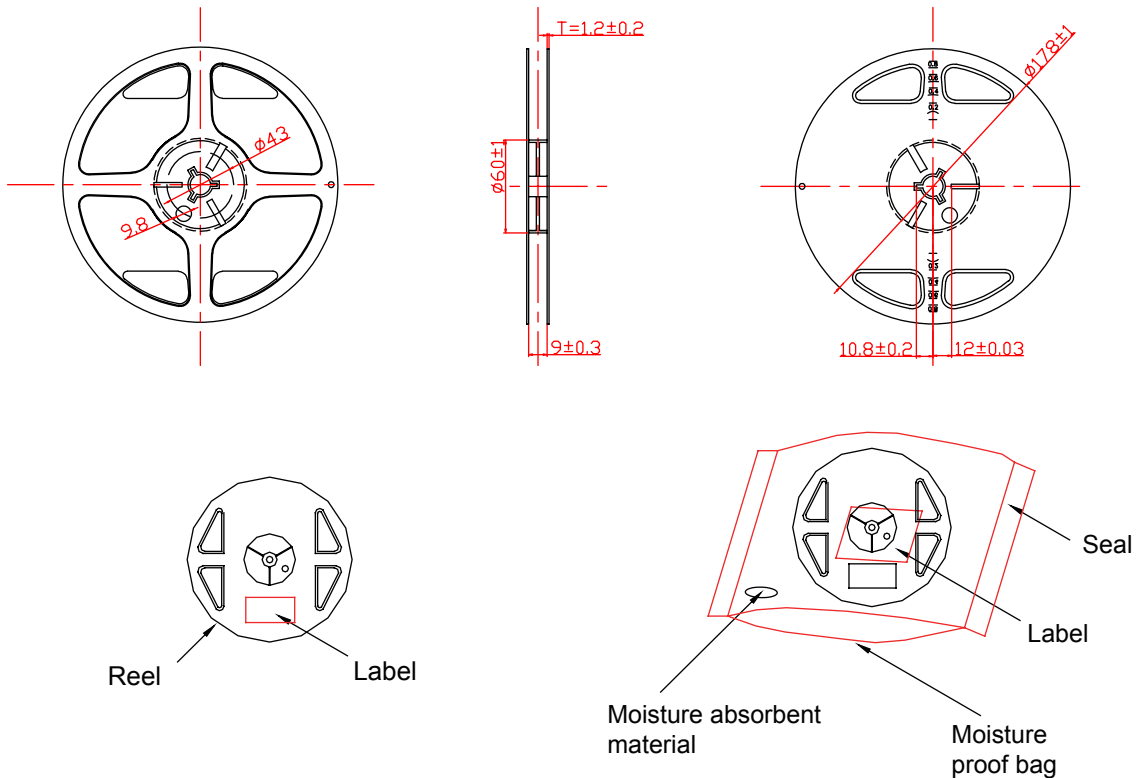

Item	Quantity	Total	Dimensions(mm)
Reel	4,000pcs	4,000pcs	R=178
Starting with 150pcs empty, and 150pcs empty at the last			

Revision History

Versions	Description	Release Date
1	Establish a Datasheet	2019/05/17

About Edison Opto

Edison Opto is a leading manufacturer of high power LED and a solution provider experienced in LDMS. LDMS is an integrated program derived from the four essential technologies in LED lighting applications- Thermal Management, Electrical Scheme, Mechanical Refinement, Optical Optimization, to provide customer with various LED components and modules. More Information about the company and our products can be found at www.edison-opto.com

Copyright©2019 Edison Opto. All rights reserved. No part of publication may be reproduced or transmitted in any form or by any means, electronic or mechanical, including photo copy, recording or any other information storage and retrieval system, without prior permission in writing from the publisher. The information in this publication are subject to change without notice.

www.edison-opto.com

For general assistance please contact:
service@edison-opto.com.tw

For technical assistance please contact:
LED.Detective@edison-opto.com.tw