



With BOS-Streamline, BOPLA is introducing a new handheld enclosure whose innovative technology and ergonomic lines create new opportunities for use in the field of mobile data recording and processing. The constructive design permits parallel or inclined arrangement of the half-shells as well as lengthways or crossways use. The enclosure can also be used for graphic-capable displays or as a membrane keypad model with continuous membrane keypad.

Depending on the design, ingress protection up to IP 65 is available. In addition to ensuring ingress protection IP 65, the BS ... DI-D decor seal – available as an accessory – also provides an anti-knock function.

If the customer does not require this decor seal, the IP 65 type with fitted round cord seal can be supplied.

Individual power supply is guaranteed for all 3 basic sizes by means of the type with a battery compartment. Of course, all BOS-Streamline designs can be adapted to customers' individual requirements by means of membrane keypads and displays as well as mechanical processing and printing.

As a system supplier, BOPLA offers this all-round service up to the assembly of complete enclosures including electronic components.

Enclosure material: ABS, decor seal BS...DI-D made of TPE. For technical data, see "the red book" main catalogue, pages 644-657.

Colour: Enclosure: graphite grey, similar to RAL 7024; light grey, similar to RAL 7035 and silver (coating process); special colours on request.

Ingress protection: Up to IP 65 / DIN EN 60529, depending on enclosure construction.

Enclosure dimensions (in mm):



Model	assembled parallel		
	L	W	H
BS 400 ...	119.3	64.9	26.5
BS 600 ...	159.4	77.9	33.5
BS 800 ...	209.3	98	34.8



Model	assembled inclined		
	L	W	H
BS 400 ...	118.9	64.9	36.5
BS 600 ...	158.9	77.9	46.9
BS 800 ...	207.8	98	52.5

Model	Max. possible display sizes (type with display lid)	Possible power supply (type with battery compartment)
BS 400 ...	Graphic display 1.8"	3 x micro (AAA)
BS 600 ...	Graphic display 2" and 2.2"	3 x mignon (AA)
BS 800 ...	Graphic display 3.5"	4 x mignon (AA)

All dimensions in mm.

Accessories (additional charge):

BS ... DI-D: Decor seal, signal yellow, similar to RAL 1003; signal red, similar to RAL 3001; signal blue, similar to RAL 5005; signal green, similar to RAL 6032; graphite grey, similar to RAL 7024; special colours on request.

BS SA-7024: Screw cover; graphite grey, similar to RAL 7024; PU = 20 pieces.

BS SA-7035: Screw cover; light grey, similar to RAL 7035; PU = 20 pieces.

Extension variants for BOS-Streamline :

Without battery compartment IP 40

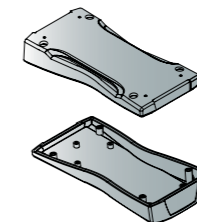

Without battery compartment IP 65

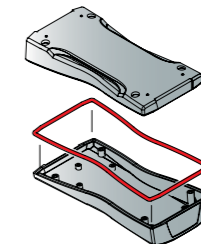

Without battery compartment, with decor seal IP 65

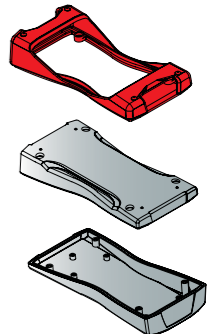

With battery compartment IP 40

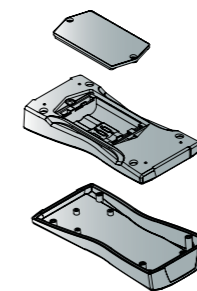

With battery compartment IP 65

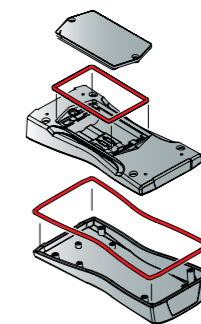

With battery compartment, with decor seal IP 65

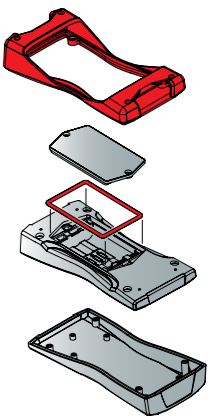

BOS-Streamline 400



BS 400 F-... / BS 402 F-...

Ergonomic hand-held enclosure with continuous membrane keypad surface. The half-shells can be assembled in parallel or inclined form. Areas for fitting different interfaces (e.g. Sub-D connectors etc.) are provided on the front. The symmetrical construction means that the hand-held enclosure can also be used crossways.



3 x AAA

BS 401 F-... / BS 403 F-... / BS 404 F-...

The integrated battery compartment holds 3 micro (AAA) batteries. The battery compartment lid can be fitted using two screws.

BS 400 / 402 F

Order designation

Model	Order no.	L	W	H	Protection	Design
BS 400 F-7024	82400124	119.3	64.9	26.5	IP 40/IP 65*	Continuous membrane surface, graphite grey, sim. to RAL 7024
BS 400 F-7035	82400135	119.3	64.9	26.5	IP 40/IP 65*	Continuous membrane surface, light grey, similar to RAL 7035
BS 400 F-S**	82400100	119.3	64.9	26.5	IP 40/IP 65*	Continuous membrane surface, silver
BS 402 F-7024	82402124	119.3	64.9	26.5	IP 65	Continuous membrane surface, fitted round cord seal, graphite grey, sim. to RAL 7024
BS 402 F-7035	82402135	119.3	64.9	26.5	IP 65	Continuous membrane surface, fitted round cord seal, light grey, similar to RAL 7035
BS 402 F-S**	82402100	119.3	64.9	26.5	IP 65	Continuous membrane surface, fitted round cord seal, silver

** Available on request – minimum order quantity: 100 pieces
* IP 65 and anti-knock protection when decor seal BS 400 DI-D... is used, see page 12

Scope of delivery:
Lid and base, 4 screws

Note:
Accessories and max. PCB dimensions, see page 13

BS 401 / 403 / 404 F

Order designation

Model	Order no.	L	W	H	Protection	Design
BS 401 F-7024	82401124	119.3	64.9	26.5	IP 40	Continuous membrane surface, battery cpmt 3x micro (AAA), graphite grey, sim. to RAL 7024
BS 401 F-7035	82401135	119.3	64.9	26.5	IP 40	Continuous membrane surface, battery cpmt 3x micro (AAA), light grey, similar to RAL 7035
BS 401 F-S**	82401100	119.3	64.9	26.5	IP 40	Continuous membrane surface, battery cpmt 3x micro (AAA), silver
BS 403 F-7024	82403124	119.3	64.9	26.5	IP 40/IP 65*	Continuous membrane surface, battery cpmt 3x micro (AAA), graphite grey, sim. to RAL 7024
BS 403 F-7035	82403135	119.3	64.9	26.5	IP 40/IP 65*	Continuous membrane surface, battery cpmt 3x Micro (AAA), light grey, similar to RAL 7035
BS 403 F-S**	82403100	119.3	64.9	26.5	IP 40/IP 65*	Continuous membrane surface, battery cpmt 3x micro (AAA), silver
BS 404 F-7024	82404124	119.3	64.9	26.5	IP 65	Continuous membrane surface, battery cpmt 3x micro (AAA), fitted round cord seal, graphite grey, sim. to RAL 7024
BS 404 F-7035	82404135	119.3	64.9	26.5	IP 65	Continuous membrane surface, battery cpmt 3x micro (AAA), fitted round cord seal, light grey, similar to RAL 7035
BS 404 F-S**	82404100	119.3	64.9	26.5	IP 65	Continuous membrane surface, battery cpmt 3x micro (AAA), fitted round cord seal, silver

** Available on request – minimum order quantity: 100 pieces
* IP 65 and anti-knock protection when decor seal BS 400 DI-D... is used, see page 12

Scope of delivery:
Lid and base, 4 screws, battery compartment lid incl. screws, battery contacts

Note:
Accessories and max. PCB dimensions, see page 13

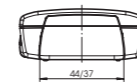

Lid - external view

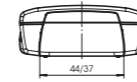
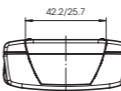
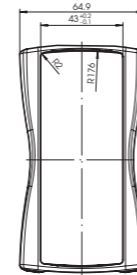

Base - external view

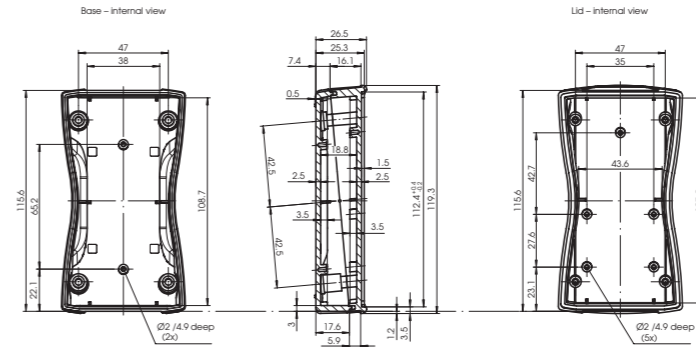
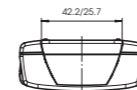
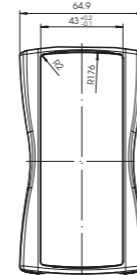

Assembled parallel



Base - external view

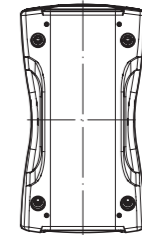

BS 400 / 402 F

Assembled inclined

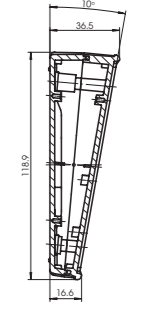
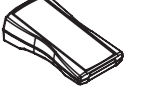

Z-2802679

BS 401 / 403 / 404 F

Assembled parallel

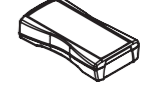

Base - external view

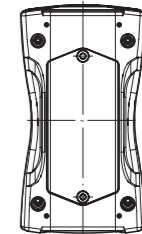

Assembled inclined

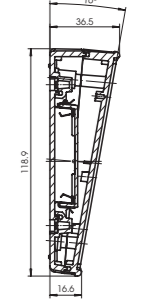

Z-2802681

BOS-Streamline 400



BS 400 DIS-... / BS 402 DIS-...

Ergonomic hand-held enclosure with display opening (graphic display 1.8") and membrane keypad surface. The half-shells can be assembled in parallel or inclined form. Areas for fitting different interfaces (e.g. Sub-D connectors etc.) are provided on the front.

The display window is not printed and can be glued into position by means of the adhesive film (included) which provides IP protection. Printing of the display window is required in order to cover the adhesive film. Display windows can be fitted and assembled on request.



3 x AAA

BS 401 DIS-... / BS 403 DIS-... / BS 404 DIS-...

The integrated battery compartment holds 3 micro (AAA) batteries. The battery compartment lid can be fitted using two screws.

BS 400 / 402 DIS

Order designation

Model	Order no.	L	W	H	Protection	Design
BS 400	82400224	119.3	64.9	26.5	IP 40/IP 65*	With display cut-out, graphite grey, sim. to RAL 7024
BS 400	82400235	119.3	64.9	26.5	IP 40/IP 65*	With display cut-out, light grey, similar to RAL 7035
BS 400	82400200	119.3	64.9	26.5	IP 40/IP 65*	With display cut-out, silver
BS 402	82402224	119.3	64.9	26.5	IP 65	With display cut-out, fitted round cord seal, graphite grey, sim. to RAL 7024
BS 402	82402235	119.3	64.9	26.5	IP 65	With display cut-out, fitted round cord seal, light grey, similar to RAL 7035
BS 402	82402200	119.3	64.9	26.5	IP 65	With display cut-out, fitted round cord seal, silver

** Available on request – minimum order quantity: 100 pieces
* IP 65 and anti-knock protection when decor seal BS 400 DI-D... is used, see page 12

Scope of delivery:

Lid and base, display window, adhesive film, 4 screws

Note:

Accessories and max. PCB dimensions, see page 13

BS 401 / 403 / 404 DIS

Order designation

Model	Order no.	L	W	H	Protection	Design
BS 401	82401224	119.3	64.9	26.5	IP 40	With display cut-out, battery cpmt 3x micro (AAA), graphite grey, sim. to RAL 7024
BS 401	82401235	119.3	64.9	26.5	IP 40	With display cut-out, battery cpmt 3x micro (AAA), light grey, similar to RAL 7035
BS 401	82401200	119.3	64.9	26.5	IP 40	With display cut-out, battery cpmt 3x micro (AAA), silver
BS 403	82403224	119.3	64.9	26.5	IP 40/IP 65*	With display cut-out, battery cpmt 3x micro (AAA), graphite grey, sim. to RAL 7024
BS 403	82403235	119.3	64.9	26.5	IP 40/IP 65*	With display cut-out, battery cpmt 3x micro (AAA), light grey, similar to RAL 7035
BS 403	82403200	119.3	64.9	26.5	IP 40/IP 65*	With display cut-out, battery cpmt 3x micro (AAA), silver
BS 404	82404224	119.3	64.9	26.5	IP 65	With display cut-out, battery cpmt 3x micro (AAA), fitted round cord seal, graphite grey, sim. to RAL 7024
BS 404	82404235	119.3	64.9	26.5	IP 65	With display cut-out, battery cpmt 3x micro (AAA), fitted round cord seal, light grey, similar to RAL 7035
BS 404	82404200	119.3	64.9	26.5	IP 65	With display cut-out, battery cpmt 3x micro (AAA), fitted round cord seal, silver

** Available on request – minimum order quantity: 100 pieces
* IP 65 and anti-knock protection when decor seal BS 400 DI-D... is used, see page 12

Scope of delivery:

Lid and base, display window, adhesive film, 4 screws, battery compartment lid incl. screws, battery contacts

Note:

Accessories and max. PCB dimensions, see page 13

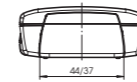

Lid - external view

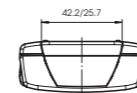
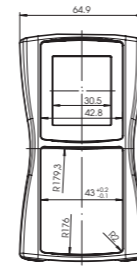

Lid - external view

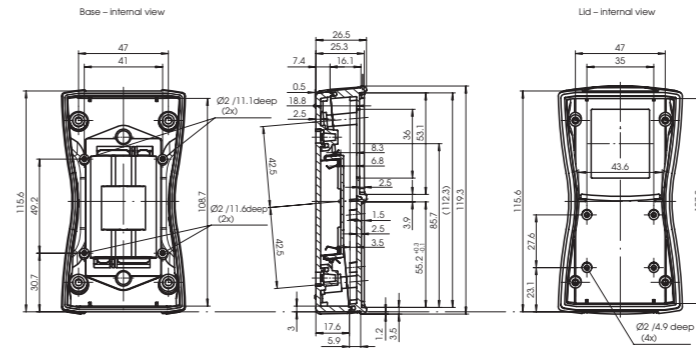
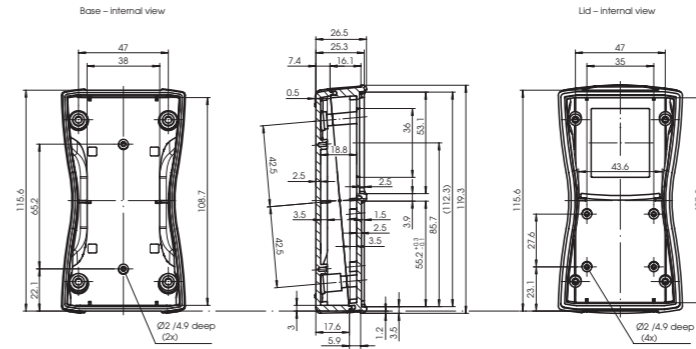
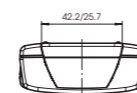
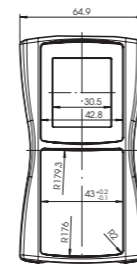

BS 400 / 402 DIS

Assembled parallel

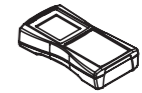

Base - external view

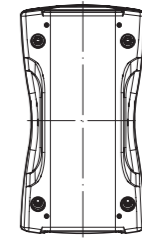

Assembled inclined

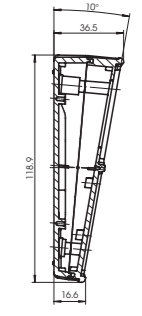
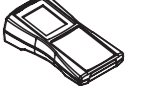

Z-2802680

BS 401 / 403 / 404 DIS

Assembled parallel

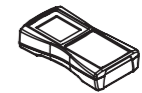

Base - external view

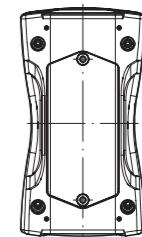

Assembled inclined

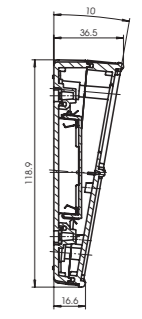
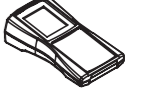

Z-2802682

Accessories for BOS-Streamline 400



Decor seal BS 400 DI-D

Order designation

Model	Order no.	L	W	H	Design
BS 400 DI-D-1003	82841003	121.9	69	23.7	Signal yellow, sim. to RAL 1003
BS 400 DI-D-3001	82843001	121.9	69	23.7	Signal red, sim. to RAL 3001
BS 400 DI-D-5005	82845005	121.9	69	23.7	Signal blue, sim. to RAL 5005
BS 400 DI-D-6032	82846032	121.9	69	23.7	Signal green, sim. to RAL 6032
BS 400 DI-D-7024	82847024	121.9	69	23.7	Graphite grey, sim. to RAL 7024

Scope of delivery:

Decor seal, 4 screws

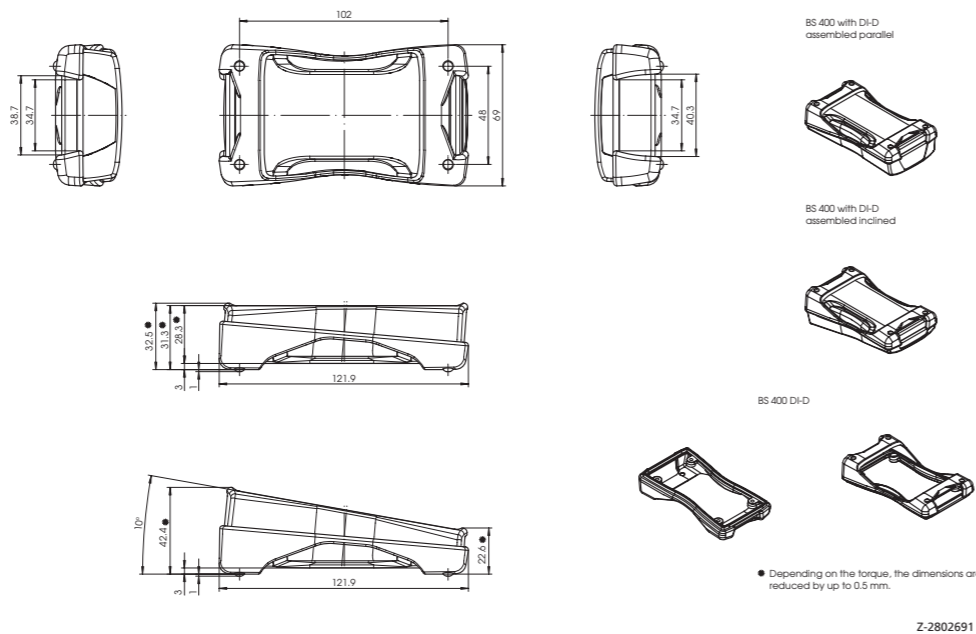

Screw cover BS SA-...

Order designation

Model	Order no.	Ø	H	Design
BS SA-7024	82800011	7.4	2.8	Screw covers, graphite grey, sim. to RAL 7024
BS SA-7035	82800010	7.4	2.8	Screw covers, light grey, similar to RAL 7035

Scope of delivery:

20 screw covers for enclosure screwing.

Note:

The screw covers are not required if decor seal DI-D is used.

BS 400 ...
max. PCB dimensions

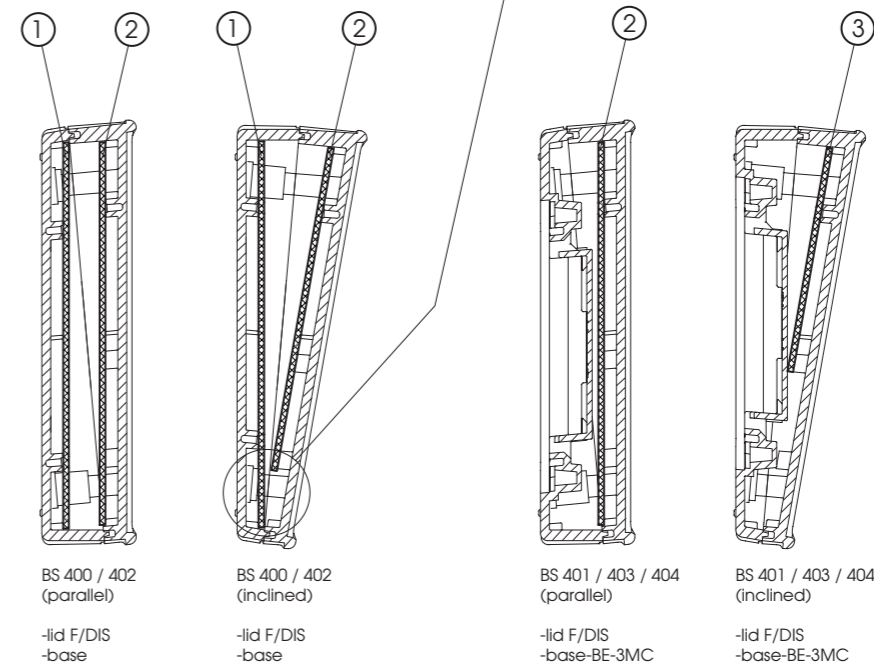
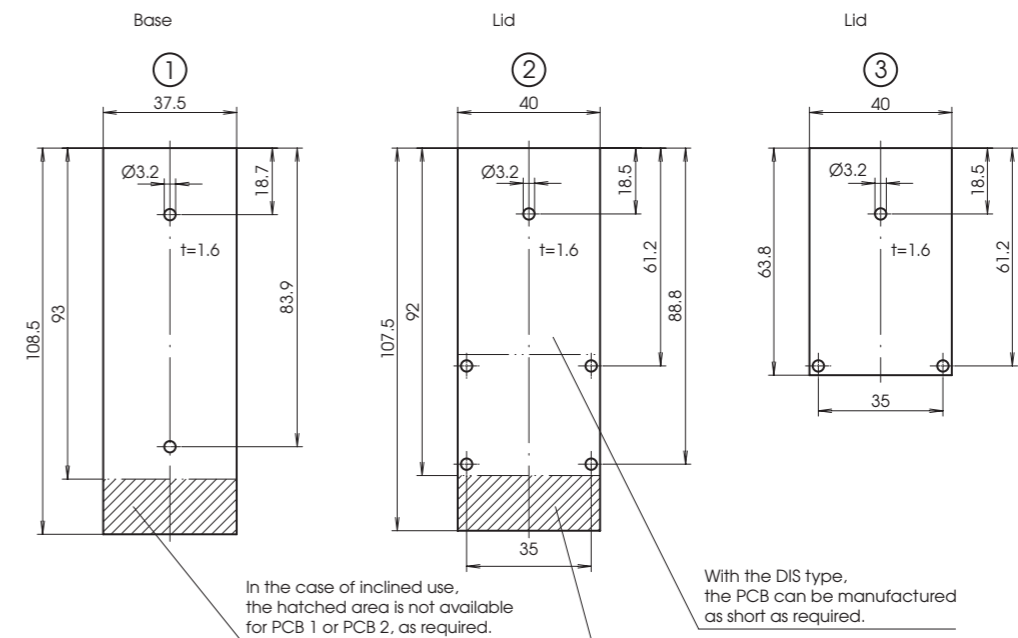

Decor seal to achieve ingress protection IP 65 coupled with anti-knock function. The decor seal has a hardness level of 40 Shore and can easily be pulled from the rear over the base. Depending on tightening torque, the decor seal increases the height of the enclosure by approx. 5.5 mm and the internal height of the enclosure by approx. 2.5 mm. Even when the decor seal is used, the lids can still be fitted in parallel or in inclined form. The enclosure screws are covered by the decor seal.



Screw covers are available in the following colours: graphite grey (similar to RAL 7024), light grey (similar to RAL 7035).