

Rev	AWO #	Description	Date	Appr
-		RELEASED	10/3/13	

6 5 4 3 2 1

APPROVED: _____

DATE: _____ TITLE: _____

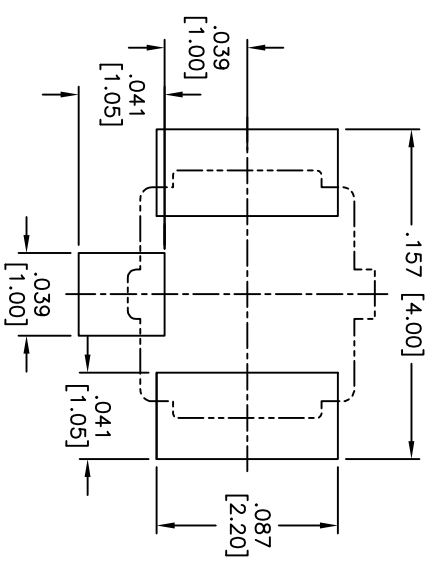
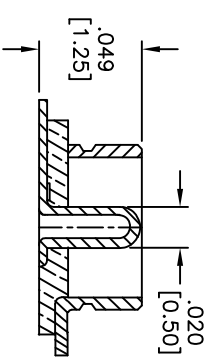
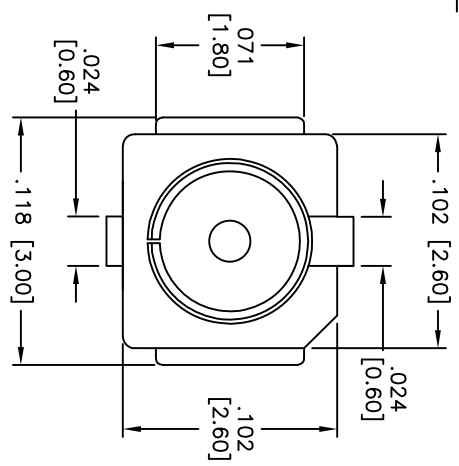

Recommended PCB Layout

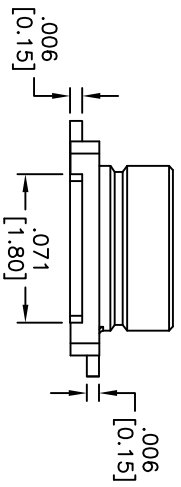
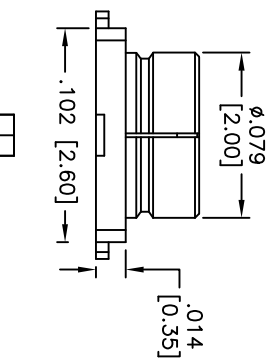
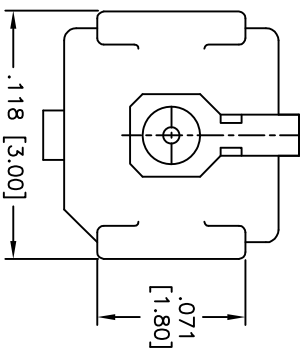

PACKAGED ON TAPE & REEL

ADAM TECH

909 Railway Avenue, Union, NJ 07083
 Phone: 908-687-5000 Fax: 908-687-5710

TITLE: RF CONNECTOR, TYPE U.F.L, 50 OHMS
 VERTICAL, TAPE & REEL PACKAGING

SPECIFICATIONS:
 Material: Insulator: Hi-temp thermoplastic, rated UL 94V-0
 Insulator color: Ivory
 Ground Pad: Metal Shell, Copper Alloy, Gold/Bright Gold plated
 Contacts: Copper Alloy, Gold/Bright Gold plated
 Electrical: Nominal Impedance: 50 ohms.
 Environmental: Lead free, RoHS compliant. 

UNLESS OTHERWISE SPECIFIED ALL DIMENSIONS ARE INCHES [MM]	
TOLERANCES: EXCEPT AS NOTED	
INCHES	HOLDS
.X ± .10	ØXX ± .10
.XX ± .020	ØXXX ± .015
.XXX ± .015	ØXXXX ± .010
APPROVALS	DATE
DRAWN AY	10/3/13
CHECKED GC	10/3/13
APPROVED	

SIZE	PART NO.
X	RF28-03-L-00-50-G-T/R
REF:	S00243T
SCALE:	NIS

REV.	SHEET 1 OF 1
------	--------------

6 5 4 3 2 1