

Data sheet | Item number: 890-202

Socket; 2-pole; Cod. A; 1,50 mm²; black

www.wago.com/890-202

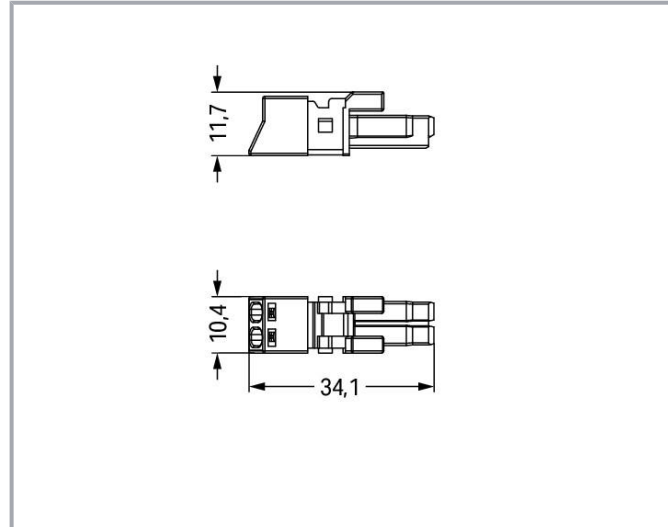
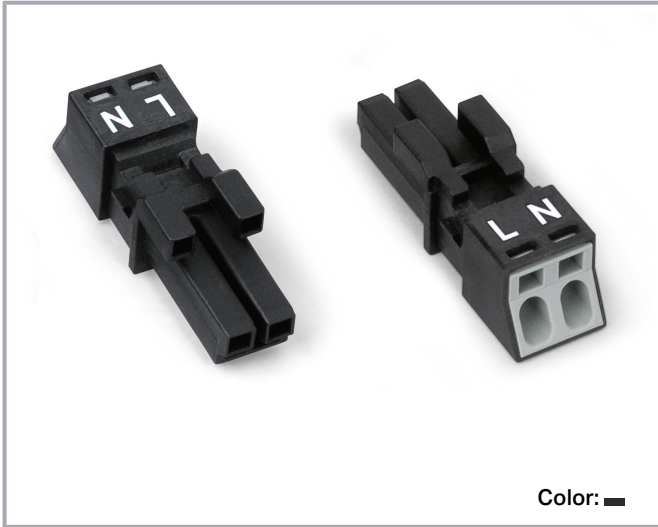

Item description

- Protected against mismatching and maintenance-free
- Push-in CAGE CLAMP® spring pressure connection technology allows solid conductors to be simply pushed into a unit.
- Low profile with 4.4 mm pole spacing
- When assembled, the installation connectors comply with IP40 and are suitable for easily accessible areas.

Data

Electrical data

Note on contact resistance

approx. 1 mΩ of contact resistance approx. 0.25 mΩ contact transition plug/socket

Ratings per IEC/EN

Ratings per	IEC/EN 60664-1
Nominal voltage (III/3)	250 V
Rated surge voltage (III/3)	4 kV
Rated current	16 A
Legend (ratings)	(III / 3) ≙ Overvoltage category III / Pollution degree 3

Subject to changes. Please also observe the further product documentation!

WAGO Kontakttechnik GmbH & Co. KG
Hansastr. 27
32423 Minden
Phone: +49571 887-0 | Fax: +49571 887-169
Email: info.de@wago.com | Web: www.wago.com

Do you have any questions about our products?
We are always happy to take your call at +49 (571) 887-44222.



Ratings per UL

Hinweis für den amerikanischen Markt	Application note for the U.S. market (USR): Some versions may also be used for current interruption in accordance with the UL certificate in select applications with currents below 5 A and voltages up to 600 V. For further information, please contact your local sales office.
Rated voltage UL 1977	600 V
Rated current UL 1977	14 A

Connection data

Connection technology	Push-in CAGE CLAMP®
Actuation type	Operating tool Push-in
Nominal cross-section	1.5 mm ²
Solid conductor	0.25 ... 1.5 mm ² / 22 ... 16 AWG
Solid conductor; push-in termination	0.75 ... 1.5 mm ² / 20 ... 16 AWG
Stranded conductor	0.25 ... 1 mm ² / 22 ... 18 AWG
Fine-stranded conductor	0.25 ... 1.5 mm ² / 22 ... 16 AWG
Fine-stranded conductor; with insulated ferrule	0.25 ... 0.75 mm ² / 22 ... 20 AWG
Fine-stranded conductor; with uninsulated ferrule	0.25 ... 0.75 mm ² / 22 ... 20 AWG
Fine-stranded conductor; with ferrule; push-in termination	0.75 mm ² / 20 AWG
Strip length	9 mm / 0.35 inch
Note (strip length)	see also packaging or instructions
Pole No.	2
Total number of connection points	2
Total number of potentials	2
Conductor entry direction to mating direction	0°

Physical data

Pin spacing	4.4 mm / 0.173 inch
Width	10.4 mm / 0.409 inch
Height	11.7 mm / 0.461 inch
Depth	34.1 mm / 1.343 inch

Mechanical data

Application	General mains applications
Coding	A

Subject to changes. Please also observe the further product documentation!



Marking	L N
Potential marking	L N
Mating force of a plug-in connection	approx. 20 ... 70 N (depending on pole number)
Retention force of a plug-in connection	Locked: > 80 N
Unmating force of a plug-in connection	Unlocked: approx. 20 ... 70 N (depending on pole number)
Number of mating cycles	200, without resistive load
Protection type	IP20
Note on protection type	IP40 with strain relief housing

Plug-in connection

Contact type (pluggable connector)	Female connector/socket
Connector (connection type)	for conductor
Mismating protection	Yes
Note on mismating protection	All WINSTA [®] components are 100% protected against mismating when: a.) plugging different numbers of poles b.) plugging while rotated 180 c.) plugging while laterally staggered d.) plugging one pole
Locking lever	Can be retrofitted
Locking of plug-in connection	locking lever
Hinweis zur Verriegelung	All connectors for mounted installations (snap-in versions for lighting fixtures or devices, all types of PCB and distribution connectors) are factory-equipped with locking levers to ensure plugs and sockets are securely locked. Additional locking levers are only required for flying leads (plug/socket).

Material data

Color	black
Insulation material	Polyamide (PA66)
Clamping spring material	Chrome nickel spring steel (CrNi)
Contact material	Copper or copper alloy (surface-treated)
Fire load	0.01 MJ
Weight	2.7 g

Environmental requirements

Processing temperature	-5 ... +40 °C
Continuous operating temperature	-35 ... +85 °C
Note on continuous operating temperature	Insulating parts for temperatures ≤ 105 °C

Subject to changes. Please also observe the further product documentation!

WAGO Kontakttechnik GmbH & Co. KG
 Hansastr. 27
 32423 Minden
 Phone: +49571 887-0 | Fax: +49571 887-169
 Email: info.de@wago.com | Web: www.wago.com

Do you have any questions about our products?
 We are always happy to take your call at +49 (571) 887-44222.

Commercial data



Product Group	20 (WINSTA)
Packaging type	BOX
Country of origin	PL
GTIN	4055143548458
Customs tariff number	85366990990

Approvals / Certificates

Country specific Approvals

Logo	Approval	Additional Approval Text	Certificate name
	CCA DEKRA Certification B.V.	EN 61535	71-11299
	CCA DEKRA Certification B.V.	IEC 61535	NL-64352

Ship Approvals













Logo	Approval	Additional Approval Text	Certificate name
	ABS American Bureau of Shipping	Steel Vessel Rules	19- HG1869855- PDA
	DNV GL Det Norske Veritas, Germanischer Lloyd	-	TAE00001Z6
	LR Lloyds Register	EN 61535	08/20047 (E2)

UL-Approvals

Logo	Approval	Additional Approval Text	Certificate name
	cURus Underwriters Laboratories Inc.	UL 1977	E45171



Subject to changes. Please also observe the further product documentation!

Counterpart

	Item no.890-112 Plug; with strain relief housing; 2-pole; 1,50 mm ² ; black	www.wago.com/890-112
	Item no.890-1606 T-distribution connector; 2-pole; Cod. A; 1 input; 2 outputs; 2 locking levers; black	www.wago.com/890-1606
	Item no.890-1615 T-distribution connector; 2-pole; Cod. A; 1 input; 2 outputs; 3 locking levers; for flying leads; black	www.wago.com/890-1615
	Item no.890-1634 h-distribution connector; 2-pole; Cod. A; 1 input; 2 outputs; outputs on one side; 2 locking levers; black	www.wago.com/890-1634
	Item no.890-212 Plug; 2-pole; 1,50 mm ² ; black	www.wago.com/890-212
	Item no.890-212/342-000 Plug; with strain relief housing; 2-pole; 1,50 mm ² ; black	www.wago.com/890-212/342-000
	Item no.890-1636 h-distribution connector; 2-pole; Cod. A; 1 input; 2 outputs; outputs on one side; 3 locking levers; for flying leads; black	www.wago.com/890-1636
	Item no.890-712 Snap-in plug; 2-pole; Cod. A; 1,50 mm ² ; black	www.wago.com/890-712
	Item no.890-812 Plug for PCBs; straight; 2-pole; Cod. A; black	www.wago.com/890-812
	Item no.890-812/011-000 Plug for PCBs; angled; 2-pole; Cod. A; black	www.wago.com/890-812/011-000
	Item no.891-8992/005-101 pre-assembled interconnecting cable; Eca; Socket/plug; 2-pole; Cod. A; H05VV-F 2 x 1.0 mm ² ; 1 m; 1,00 mm ² ; black	www.wago.com/891-8992/005-101
	Item no.891-8992/205-101 pre-assembled connecting cable; Eca; Plug/open-ended; 2-pole; Cod. A; H05VV-F 2 x 1.0 mm ² ; 1 m; 1,00 mm ² ; black	www.wago.com/891-8992/205-101

Required accessories

Strain relief plate

	Item no.: 890-502 Strain relief housing; 2-pole; with locking clip; for 1 cable; 3.8 ... 8.2 mm; 30 mm; black	www.wago.com/890-502
	Item no.: 890-502/342-000 Strain relief housing; 2-pole; with locking clip; for 1 cable; 3.8 ... 8.2 mm; 17.5 mm; black	www.wago.com/890-502/342-000
	Item no.: 890-512	

Subject to changes. Please also observe the further product documentation!

 Strain relief housing; 2-pole; with locking clip; for 1 cable; 3.8 ... 8.2 mm; 30 mm; white www.wago.com/890-512

 **Item no.: 890-512/342-000**
Strain relief housing; 2-pole; with locking clip; for 1 cable; 3.8 ... 8.2 mm; 17.5 mm; white www.wago.com/890-512/342-000

tools

 **Item no.: 890-382**
Operating tool; 2-way; green www.wago.com/890-382

Locking lever

 **Item no.: 890-101**
Locking lever; for manual operation; black www.wago.com/890-101

 **Item no.: 890-111**
Locking lever; for flying leads; for tool operation; black www.wago.com/890-111

 **Item no.: 890-121**
Locking lever; for manual operation; white www.wago.com/890-121

 **Item no.: 890-131**
Locking lever; for flying leads; for tool operation; white www.wago.com/890-131

assembling

 **Item no.: 890-310**
Mounting carrier; 2- to 5-pole; for flying leads; black www.wago.com/890-310

 **Item no.: 890-311**
Mounting carrier; 2- to 5-pole; for flying leads; white www.wago.com/890-311

Compatible products

protection

 **Item no.: 897-2001**
Protective cap; Type1; for sockets and plugs; PVC; red www.wago.com/897-2001

tools

 **Item no.: 210-719**
Operating tool; Blade: 2.5 x 0.4 mm; with a partially insulated shaft www.wago.com/210-719

Downloads

Documentation

Bid Text

Item no.	Date	File name	Size	Action
890-202	Feb 19, 2019	X81 - Datei	xml 3.0 kB	Download

890-202

Subject to changes. Please also observe the further product documentation!



doc - Datei

Jun 8, 2015

doc
23.6 kB

[Download](#)

CAD/CAE-Data

CAE data

EPLAN Data Portal 890-202

[URL](#)

[Download](#)

WSCAD Universe 890-202

[URL](#)

[Download](#)

ZUKEN Portal 890-202

[URL](#)

[Download](#)

CAD data

2D/3D Models 890-202

[URL](#)

[Download](#)

Environmental Product Compliance

Compliance Search

Environmental Product Compliance 890-202

[URL](#)

[Download](#)

Socket; 2-pole; Cod. A; 1,50 mm²; black

Installation Notes

Subject to changes. Please also observe the further product documentation!

WAGO Kontakttechnik GmbH & Co. KG
Hansastr. 27
32423 Minden
Phone: +49571 887-0 | Fax: +49571 887-169
Email: info.de@wago.com | Web: www.wago.com

Do you have any questions about our products?
We are always happy to take your call at +49 (571) 887-44222.

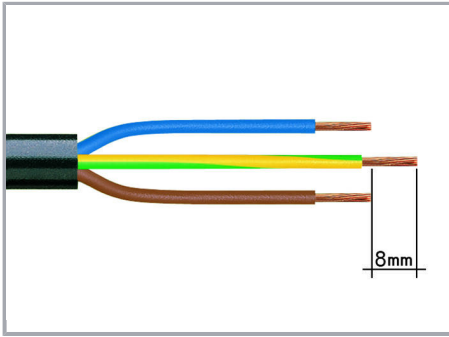

1. Strip length, outer insulation = 30 mm (2-pole), 37 mm (3-pole), 45 mm (4- and 5-pole)
2. Strip length = 9 mm
3. Extended ground conductor = 8 mm

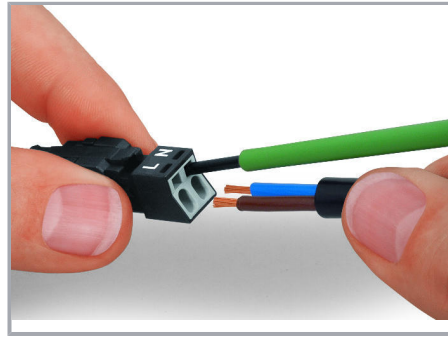

To terminate fine-stranded conductors, open the clamping unit via screwdriver – 2.5 mm blade width – and insert a stripped conductor until it hits the backstop. Terminate solid conductors by simply pushing them in.

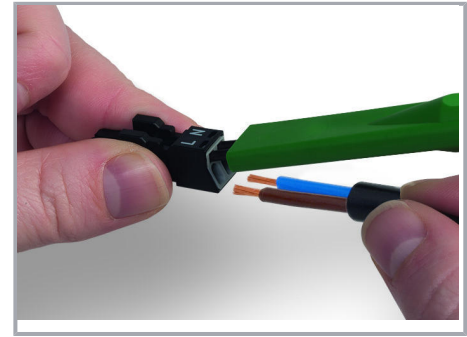

To terminate fine-stranded conductors, open clamping units via operating tool (890-382) and insert stripped conductors until they hit backstop.

Terminate solid conductors by simply pushing them in.

Subject to changes. Please also observe the further product documentation!

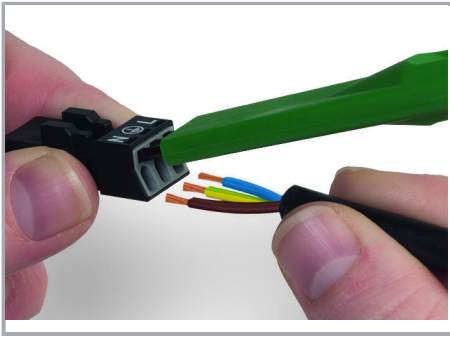

To terminate fine-stranded conductors, open clamping units via operating tool (890-383) and insert stripped conductors until they hit backstop.

Terminate solid conductors by simply pushing them in.

Installation

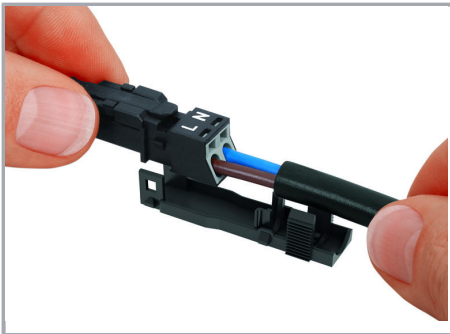

Latch the wired connector into the base of the strain relief housing.

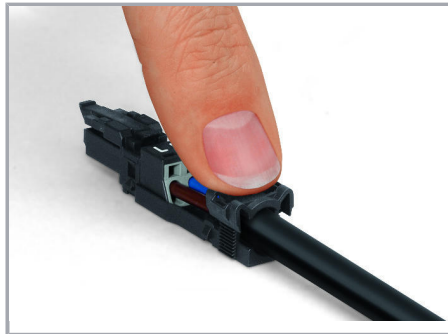

Push down strain relief clamp by hand.



Push down strain relief clamp with 2.5 mm screwdriver alternately on both sides.

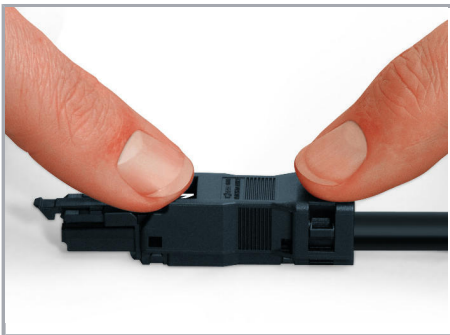

Latch the top of the strain relief housing.

Subject to changes. Please also observe the further product documentation!



The printed marking of the connector is clearly visible in the openings of the strain relief housing.

Product family

WINSTA® MINI

[Show all products from the family](#)

Subject to changes. Please also observe the further product documentation!