

Data sheet | Item number: 770-114

Plug; with strain relief housing; 4-pole; Cod. A; 4,00 mm²; black

www.wago.com/770-114

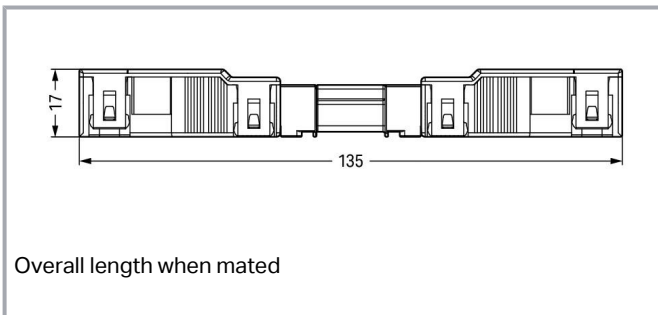
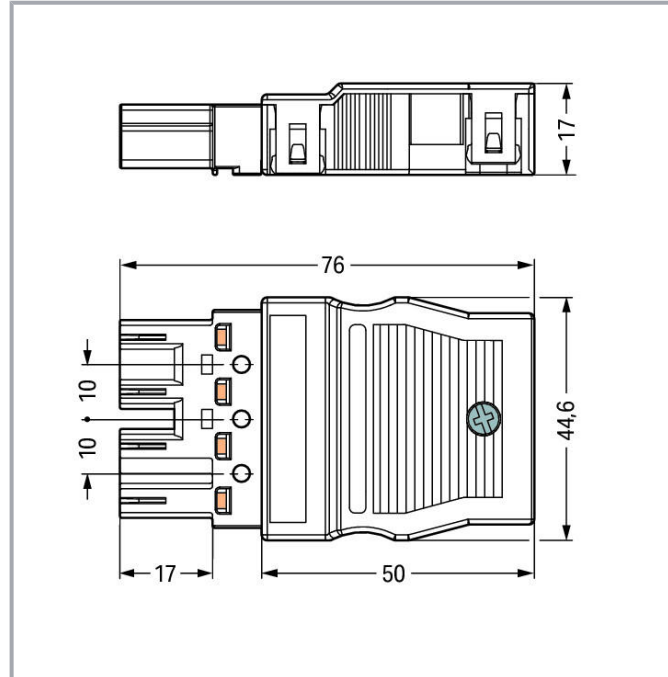

Item description

- Set: Plug 770-214 and strain relief housing 770-504
- Protected against mismatching and maintenance-free
- Push-in CAGE CLAMP® spring pressure connection technology allows solid conductors to be simply pushed into a unit
- Two-wire connection per pole for loops or bridges
- Additional variable coding is possible

Subject to changes. Please also observe the further product documentation!

WAGO Kontakttechnik GmbH & Co. KG
Hansastr. 27
32423 Minden
Phone: +49571 887-0 | Fax: +49571 887-169
Email: info.de@wago.com | Web: www.wago.com

Do you have any questions about our products?
We are always happy to take your call at +49 (571) 887-44222.



Data

Electrical data

Note on contact resistance	approx. 1 mΩ of contact resistance approx. 0.25 mΩ contact transition plug/socket
----------------------------	---

Ratings per IEC/EN

Ratings per	IEC/EN 60664-1
Nominal voltage (III/3)	400 V
Rated surge voltage (III/3)	6 kV
Rated current	25 A
Legend (ratings)	(III / 3) ≙ Overvoltage category III / Pollution degree 3

Ratings per UL

Hinweis für den amerikanischen Markt	Application note for the U.S. market (USR): Some versions may also be used for current interruption in accordance with the UL certificate in select applications with currents below 16 A and voltages up to 600 V. For further information, please contact your local sales office.
Rated voltage UL 1977	600 V
Rated current UL 1977	23 A

Connection data

Connection technology	Push-in CAGE CLAMP®
Actuation type	Operating tool Push-in
Nominal cross-section	4 mm ²
Solid conductor	0.5 ... 4 mm ² / 20 ... 12 AWG
Solid conductor; push-in termination	1.5 ... 4 mm ² / 16 ... 12 AWG
Stranded conductor	0.5 ... 2.5 mm ² / 20 ... 14 AWG
Fine-stranded conductor	0.5 ... 4 mm ² / 20 ... 12 AWG
Fine-stranded conductor; with insulated ferrule	0.25 ... 1.5 mm ² / 20 ... 16 AWG
Fine-stranded conductor; with uninsulated ferrule	0.25 ... 2.5 mm ² / 20 ... 14 AWG
Fine-stranded conductor; with ferrule; push-in termination	1.5 mm ² / 16 AWG
Strip length	9 mm / 0.35 inch
Note (strip length)	see also packaging or instructions
Pole No.	4
Total number of connection points	8

Subject to changes. Please also observe the further product documentation!



Total number of potentials	4
Ground function	with preceding ground contact
Connectable sheathed cable diameter	9 ... 13 mm
Conductor entry direction to mating direction	0°
Strip length (outer insulation)	55 mm

Physical data

Pin spacing	10 mm / 0.394 inch
Width	44.6 mm / 1.756 inch
Height	17 mm / 0.669 inch
Depth	75.9 mm / 2.988 inch

Mechanical data

Application	General mains applications
Coding	A
Marking	N 2/L 1/L'
Potential marking	N 2/L 1/L'
Mating force of a plug-in connection	approx. 20 ... 70 N (depending on pole number)
Retention force of a plug-in connection	Locked: > 80 N
Unmating force of a plug-in connection	Unlocked: approx. 20 ... 70 N (depending on pole number)
Number of mating cycles	200, without resistive load
Protection type	IP20
Note on protection type	When mated and secured with a strain relief housing: IP2xC (These compact connectors are not designed for use in open, easily accessible areas!)

Plug-in connection

Contact type (pluggable connector)	Male connector/plug
Connector (connection type)	for conductor
Mismating protection	Yes
Note on mismating protection	All WINSTA [®] components are 100% protected against mismating when: a.) plugging different numbers of poles b.) plugging while rotated 180 c.) plugging while laterally staggered d.) plugging one pole
Locking lever	Can be retrofitted
Locking of plug-in connection	locking lever
Hinweis zur Verriegelung	All connectors for mounted installations (snap-in versions for lighting fixtures or devices, all types of PCB and distribution

Subject to changes. Please also observe the further product documentation!



connectors) are factory-equipped with locking levers to ensure plugs and sockets are securely locked. Additional locking levers are only required for flying leads (plug/socket).

Strain relief	strain relief housing
---------------	-----------------------

Material data

Color	black
Insulation material	Polyamide (PA66)
Clamping spring material	Chrome nickel spring steel (CrNi)
Contact material	Copper or copper alloy (surface-treated)
Fire load	0.574 MJ
Weight	24.9 g

Environmental requirements



Processing temperature	-5 ... +40 °C
Continuous operating temperature	-35 ... +85 °C
Note on continuous operating temperature	Insulating parts for temperatures ≤ 105 °C

Commercial data

Product Group	20 (WINSTA)
Packaging type	BOX
Country of origin	DE
GTIN	4044918254410
Customs tariff number	85366990990

Approvals / Certificates

Country specific Approvals



Logo	Approval	Additional Approval Text	Certificate name
	CCA DEKRA Certification B.V.	EN 61535	2173495.02
	CCA DEKRA Certification B.V.	IEC 61535	NL-32105
	VDE VDE Prüf- und Zertifizierungsinstitut	EN 61535	40029808

Subject to changes. Please also observe the further product documentation!

WAGO Kontakttechnik GmbH & Co. KG
Hansastr. 27
32423 Minden
Phone: +49571 887-0 | Fax: +49571 887-169
Email: info.de@wago.com | Web: www.wago.com

Do you have any questions about our products?
We are always happy to take your call at +49 (571) 887-44222.







Ship Approvals

Logo	Approval	Additional Approval Text	Certificate name
	ABS American Bureau of Shipping	-	19- HG1868589- PDA
	DNV GL Det Norske Veritas, Germanischer Lloyd	-	TAE00001Z6
	LR Lloyds Register	IEC 61984	02/20050 (E6)







UL-Approvals

Logo	Approval	Additional Approval Text	Certificate name
	cURus Underwriters Laboratories Inc.	UL 1977	E45171 Sec. 9

Counterpart



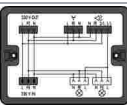
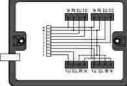

	Item no.770-104 Socket; with strain relief housing; 4-pole; Cod. A; 4,00 mm ² ; black	www.wago.com/770-104
	Item no.770-204 Socket; 4-pole; Cod. A; 4,00 mm ² ; black	www.wago.com/770-204
	Item no.770-626 T-distribution connector; 4-pole; Cod. A; 1 input; 2 outputs; 2 locking levers; black	www.wago.com/770-626
	Item no.770-627 T-distribution connector; 4-pole; Cod. A; 1 input; 2 outputs; 3 locking levers; for flying leads; black	www.wago.com/770-627
	Item no.770-704 Snap-in socket; 4-pole; Cod. A; 4,00 mm ² ; black	www.wago.com/770-704
	Item no.770-704/009-000 Snap-in socket; with protruding mating face; 4-pole; Cod. A; 4,00 mm ² ; black	www.wago.com/770-704/009-000

Subject to changes. Please also observe the further product documentation!

	Item no.770-804 Socket for PCBs; straight; 4-pole; Cod. A; black	www.wago.com/770-804
	Item no.770-944 h-distribution connector; 4-pole; Cod. A; 1 input; 2 outputs; outputs on one side; 2 locking levers; black	www.wago.com/770-944
	Item no.770-804/011-000 Socket for PCBs; angled; 4-pole; Cod. A; black	www.wago.com/770-804/011-000
	Item no.771-9994/006-101 pre-assembled interconnecting cable; Eca; Socket/plug; 4-pole; Cod. A; H05VV-F 4G 1.5 mm ² ; 1 m; 1,50 mm ² ; black	www.wago.com/771-9994/006-101
	Item no.770-945 h-distribution connector; 4-pole; Cod. A; 1 input; 2 outputs; outputs on one side; 3 locking levers; for flying leads; black	www.wago.com/770-945
	Item no.771-9994/106-101 pre-assembled connecting cable; Eca; Socket/open-ended; 4-pole; Cod. A; H05VV-F 4G 1.5 mm ² ; 1 m; 1,50 mm ² ; black	www.wago.com/771-9994/106-101
	Item no.899-631/180-000 Distribution box; Motion/presence detector; 1 input; 5 outputs; Cod. A; MIDI; black	www.wago.com/899-631/180-000
	Item no.899-631/453-000 Distribution box; supply cable entry; 4 outputs; Cod. A; MIDI; black	www.wago.com/899-631/453-000

Required accessories

Locking lever

	Item no.: 770-101 Locking lever; for flying leads; for manual operation; black	www.wago.com/770-101
	Item no.: 770-111 Locking lever; for flying leads; for tool operation; black	www.wago.com/770-111
	Item no.: 770-121 Locking lever; for flying leads; for manual operation; white	www.wago.com/770-121
	Item no.: 770-131 Locking lever; for flying leads; for tool operation; white	www.wago.com/770-131

protection

	Item no.: 770-360 Lockout cap; for plugs; 5-pole; separable; yellow	www.wago.com/770-360
--	---	--





Compatible products

protection

Subject to changes. Please also observe the further product documentation!

	Item no.: 897-2005 Protective cap; Type4; for sockets and plugs; PVC; red	www.wago.com/897-2005
---	---	--

Marking accessories

	Item no.: 770-450 Marker card; Plastic; white	www.wago.com/770-450
	Item no.: 770-450/000-001 Marker card; Plastic; green	www.wago.com/770-450/000-001
	Item no.: 770-450/000-002 Marker card; Plastic; yellow	www.wago.com/770-450/000-002
	Item no.: 770-450/000-005 Marker card; Plastic; red	www.wago.com/770-450/000-005
	Item no.: 770-450/000-006 Marker card; Plastic; blue	www.wago.com/770-450/000-006
	Item no.: 770-450/000-012 Marker card; Plastic; orange	www.wago.com/770-450/000-012

tools

	Item no.: 210-719 Operating tool; Blade: 2.5 x 0.4 mm; with a partially insulated shaft	www.wago.com/210-719
--	---	--

Downloads

Documentation

Bid Text

770-114 doc - Datei	Jun 8, 2015	doc 24.1 kB	Download
770-114 X81 - Datei	Feb 19, 2019	xml 3.1 kB	Download

CAD/CAE-Data

CAD data

2D/3D Models 770-114	URL	Download
----------------------	-----	----------

Subject to changes. Please also observe the further product documentation!

CAE data

EPLAN Data Portal 770-114	URL	Download
WSCAD Universe 770-114	URL	Download
ZUKEN Portal 770-114	URL	Download

Environmental Product Compliance

Compliance Search

Environmental Product Compliance 770-114 Plug; with strain relief housing; 4-pole; Cod. A; 4,00 mm ² ; black	URL	Download
--	---------------------	--------------------------

Installation Notes

Conductor termination

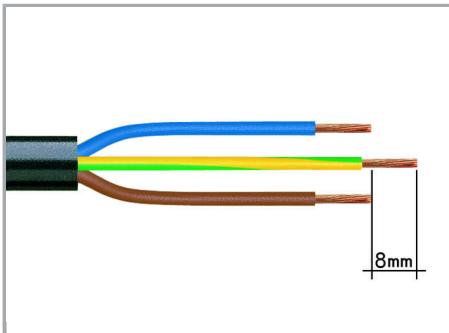

1. Strip length, outer insulation = 35 mm (2-pole), 55 mm (3- to 5-pole)

2. Strip length = 9 mm

3. Extended ground conductor = 8 mm

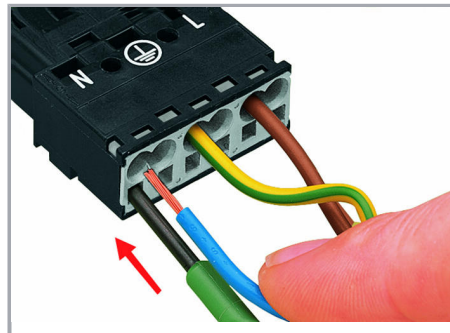

To terminate fine-stranded conductors, open the clamping unit via screwdriver (2.5 mm blade width) and insert a stripped conductor until it hits the backstop.

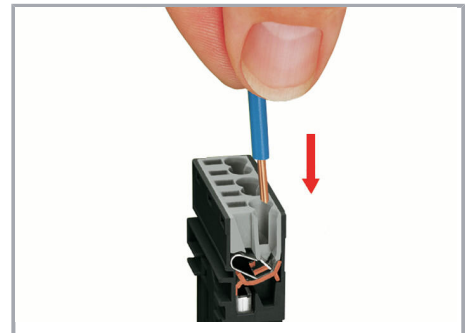

Insert the stripped solid conductor until it hits the backstop.

Subject to changes. Please also observe the further product documentation!

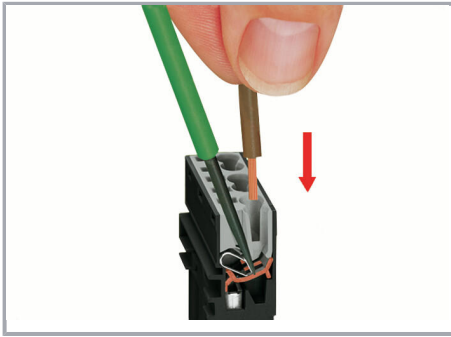

To terminate fine-stranded conductors, open the clamping unit via screwdriver (2.5 mm blade width) and insert a stripped conductor until it hits the backstop.

Conductor removal

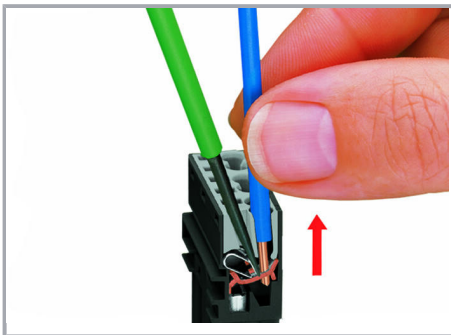

To remove the conductor, actuate the clamp via screwdriver (2.5 mm blade width) and pull out the conductor.

Installation

Subject to changes. Please also observe the further product documentation!

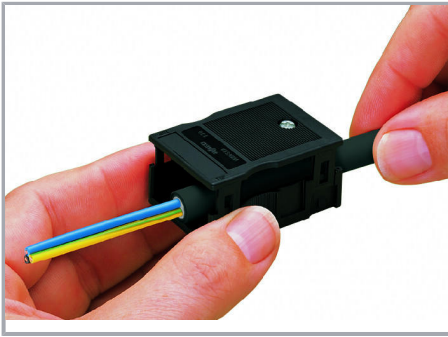

We recommend pulling the pre-latched strain relief housing over the cable prior to termination. However, the strain relief can be mounted at a later time as well.

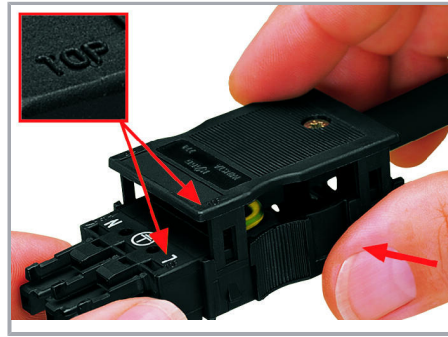

Latch the strain relief housing onto the plug /socket. Note the "TOP" inscription.

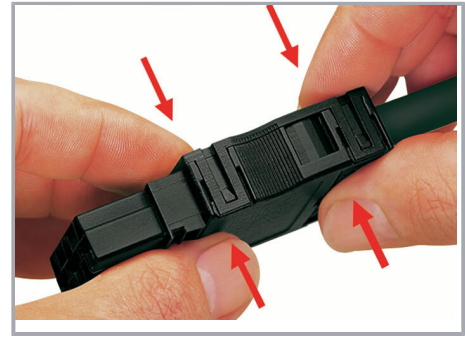

Prepare strain relief housing by snapping together upper and bottom part.



Tighten strain relief screw with screwdriver (2.5 mm blade width).

Product family

WINSTA® MIDI

[Show all products from the family](#)

Subject to changes. Please also observe the further product documentation!