



C250402 Conical Bent \varnothing 0.8 for AL250 & AP250

C250 cartridges have been specially designed to work with AL250 Auto-Feed iron and AP250 Solder Feed Iron.

These cartridges can be aligned using the anti-rotation screw incorporated on the tool. JBC Long Life Tips offer instant heat up, excellent heat transfer and great durability.

They last 5 times longer than other brands thanks to the JBC Most Efficient Soldering System and the Sleep & Hibernation features.

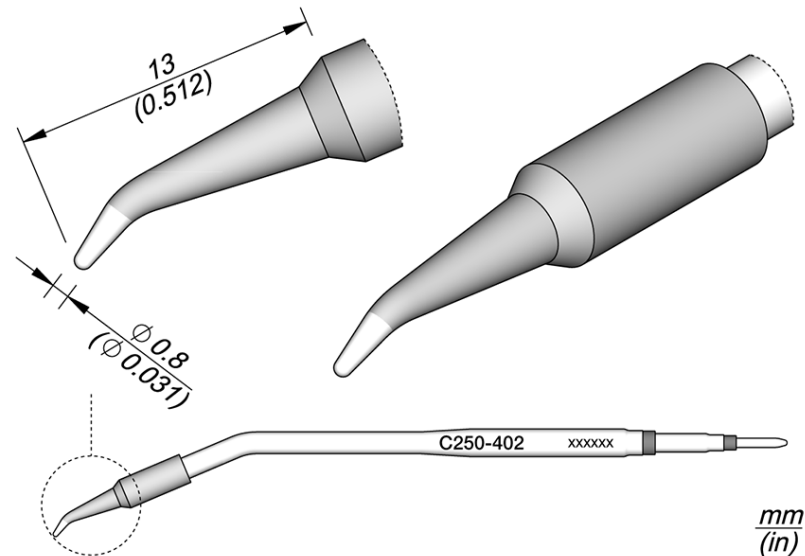

SPECIFICATIONS

Net weight	0,008 kg (0.02lb)
Package weight	15 gr (0.03 lb)
Package dimensions	127 x 31 x 31 mm

5.00 x 1.22 x 1.22 in

8 gr (0.02 lb)

CONNECTABLES

Compatible tools

Solder Feed Iron Auto-Feed Iron
AP250-A AL250-B

