

Z-POWER LED Series

Technical Datasheet for F50381

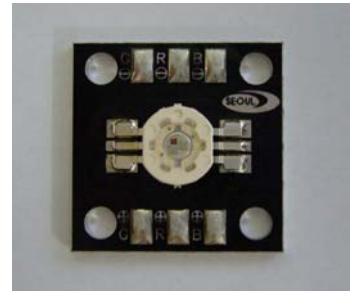

Z-Power series is designed for high current operation and high flux output applications.

Z-Power LED's thermal management perform exceeds other power LED solutions.

It incorporates state of the art SMD design and Thermal emission material.

Full color Z-Power LED is the first full color package, using 3 RGB power chips and rendering 7colors.

In case of the full color product used in architectural lighting or decoration, it emits 7colors in one package so that it can render a clear mixed color when it is mixed with other colors.

Features

- Super high Flux output and high Luminance
- Designed for high current operation
- Low thermal resistance
- SMT solderability
- Lead Free product
- RoHS compliant

Application

- Mobile phone flash
- Automotive interior / exterior lighting
- Automotive signal lighting
- Automotive forward lighting
- General Torch
- Architectural lighting
- LCD TV / Monitor Backlight
- Projector light source
- Traffic signals
- Task lighting
- Decorative / Pathway lighting
- Remote / Solar powered lighting
- Household appliances



Full Code of Z-Power LED Series

Full code form : $X_1 X_2 X_3 X_4 X_5 X_6 - X_7 X_8 - X_9 X_{10} X_{11} X_{12} X_{13} X_{14}$

1. Part Number

- X_1 : Color
- X_2 : Z-Power LED series number
- X_3 : LENS type
- X_4 : Chip quantity (or Power Dissipation)
- X_5 : Package outline size
- X_6 : Type of PCB

2. Internal Number

- X_7
- X_8

3. Code Labeling

- X_9 : Red Luminous flux
- X_{10} : Green Luminous flux
- X_{11} : Blue Luminous flux
- X_{12} : Red Dominant wavelength
- X_{13} : Green Dominant wavelength
- X_{14} : Blue Dominant wavelength

4. Sticker Diagram on Reel & Aluminum Vinyl Bag

PART NO. : $X_1 X_2 X_3 X_4 X_5 X_6 - X_7 X_8$
[Barcode]
QUANTITY : ###
[Barcode]
LOT NUMBER : #####
[Barcode]
BIN CODE : $X_9 X_{10} X_{11} X_{12} X_{13} X_{14}$
[Barcode]



Outline Dimensions

1. Emitter Type

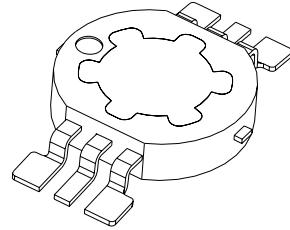
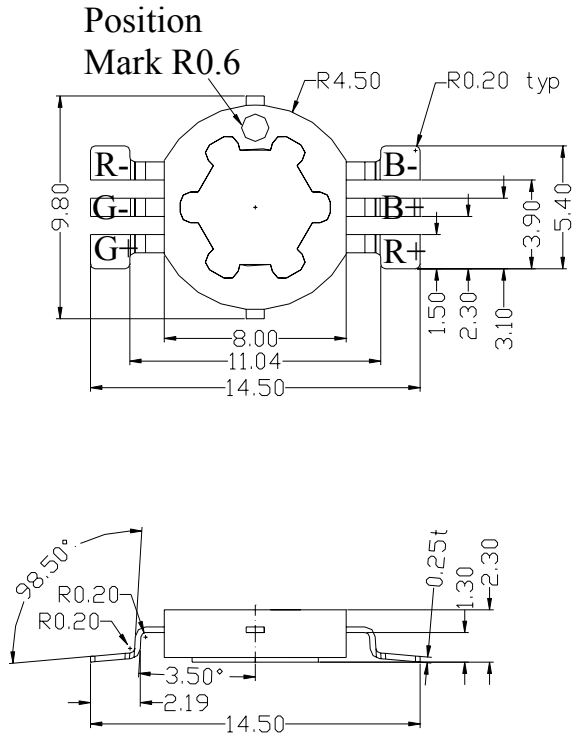

Isometric View

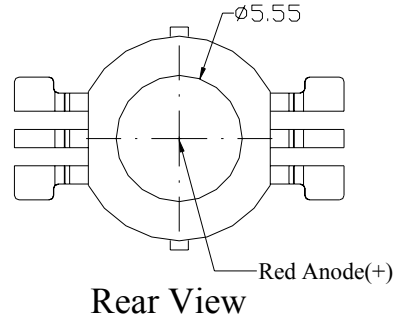

Rear View

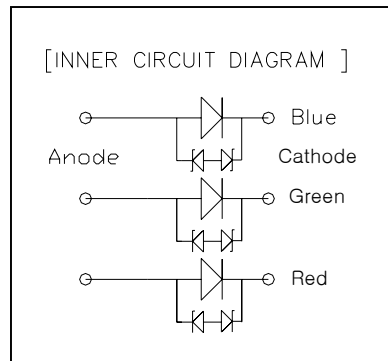

Notes :

1. All dimensions are in millimeters. (tolerance : ± 0.2)
2. Scale : none
3. Slug of package is connected to anode of Red.
4. Insulation voltage of Metal PCB is 6.5kVAC

*The appearance and specifications of the product may be changed for improvement without notice.



Outline Dimensions

2. PCB Type

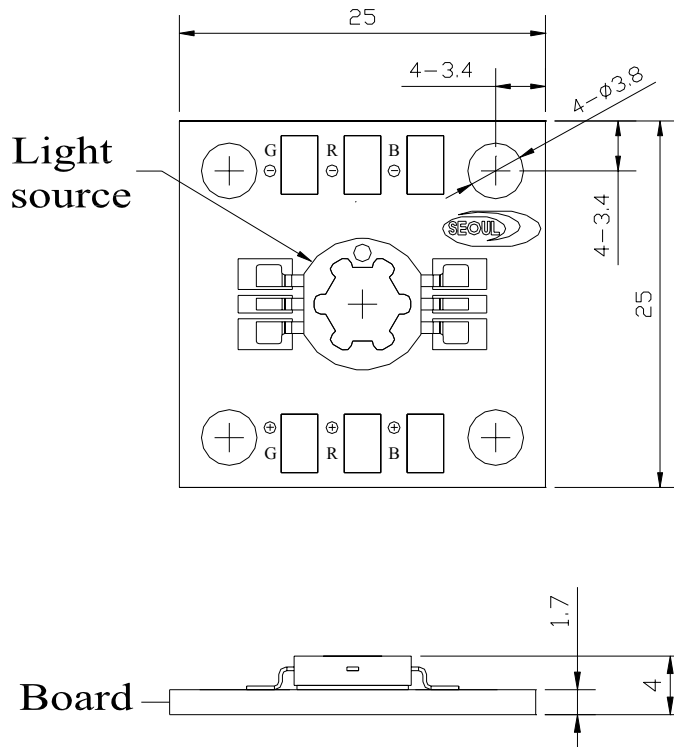

<Rectangular type>

Notes :

1. All dimensions are in millimeters. (tolerance : ± 0.2)
2. Scale : none
3. Slug of package is connected to anode of Red.

*The appearance and specifications of the product may be changed for improvement without notice.



Characteristics for Dome type Z-Power LED

1. Electro-Optical Characteristics(Red,Green and Blue All color in use)

1-1 Electro-Optical characteristics at $T_A=25^{\circ}\text{C}$

Parameter	Symbol	Value			Unit
		Min	Typ	Max	
Total Luminous Flux ^[1]	Φ_V ^[2]	41.5	78 (58) ^[3]	-	lm
Forward Voltage ^[4]	V_F	-	R:2.5 B:3.4 G:3.7	-	V
Forward Current	I_F	R,G,B:350			mA
View Angle ^[5]	2θ 1/2	130			deg.
Thermal resistance ^[6]	$R_{\theta_{J-B}}$	R: 30, G: 20, B: 19 @ R, G, B 350mA			$^{\circ}\text{C} / \text{W}$

1-2 Absolute Maximum Ratings

Parameter	Symbol	Value			Unit
		Red	Green	Blue	
Forward Current	I_F	0.4	0.4	0.4	A
Power Dissipation	P_D	1.2	1.6	1.6	W
Junction Temperature	T_j	100	125	125	$^{\circ}\text{C}$
Operating Temperature	T_{opr}	-30 ~ +85			$^{\circ}\text{C}$
Storage Temperature	T_{stg}	-40 ~ +120			$^{\circ}\text{C}$
ESD Sensitivity ^[7]	-	$\pm 10,000\text{V}$ HBM			-

*Notes :

[1] SSC maintains a tolerance of $\pm 10\%$ on flux and power measurements.

[2] Φ_V is the total luminous flux output as measured with an integrated sphere under 350 mA red, green and blue.

[3] Reference white balance current condition ($I_F = \text{R:170, G:370, B:150 mA}$)

[4] A tolerance of $\pm 0.1\text{V}$ on forward voltage measurements

[5] Viewing angle is the reference condition.

[6] $R_{\theta_{J-B}}$ is measured with a SSC metal core pcb. ($25^{\circ}\text{C} \leq T_j \leq 110^{\circ}\text{C}$)
Insulation voltage of Metal PCB is 6.5kVAC

[7] It is included the zener chip to protect the product from ESD.
(bidirectional zener diode, $V_b = 5.6\text{V}$)

* **Caution**

1. Please do not drive at rated current more than 5 sec. without proper heat sink



2. Blue

2-1 Electro-Optical characteristics at $I_F=350\text{mA}$, $T_A=25^\circ\text{C}$

Parameter	Symbol	Value			Unit
		Min	Typ	Max	
Total Luminous Flux [1]	Φ_V [2]	6.0	6.8	-	lm
Forward Voltage [4]	λ_D	455	460	467	nm
Forward Current	V_F	3.0	3.5	4.0	V
View Angle[5]	2θ 1/2	130			deg.
Thermal resistance[6]	$R_{\theta_{J-B}}$	12.5			$^\circ\text{C} / \text{W}$

2-2 Absolute Maximum Ratings

Parameter	Symbol	Value	Unit
Forward Current	I_F	0.4	A
Power Dissipation	P_D	1.6	W
Junction Temperature	T_j	125	$^\circ\text{C}$
Operating Temperature	T_{opr}	-30 ~ +85	$^\circ\text{C}$
Storage Temperature	T_{stg}	-40 ~ +120	$^\circ\text{C}$
ESD Sensitivity [7]	-	$\pm 10,000\text{V HBM}$	-

*Notes :

- [1] SSC maintains a tolerance of $\pm 10\%$ on flux and power measurements.
- [2] Φ_V is the total luminous flux output as measured with an integrated sphere.
- [3] Dominant wavelength is derived from the CIE 1931 Chromaticity diagram.
A tolerance of $\pm 1.0\text{nm}$ for dominant wavelength
- [4] A tolerance of $\pm 0.1\text{V}$ on forward voltage measurements
- [5] Viewing angle is the reference condition.
- [6] $R_{\theta_{J-B}}$ is measured with a SSC metal core pcb. ($25^\circ\text{C} \leq T_j \leq 110^\circ\text{C}$)
Insulation voltage of Metal PCB is 6.5kVAC
- [7] It is included the zener chip to protect the product from ESD.
(bidirectional zener diode, $V_b = 5.6\text{V}$)

* Caution

1. Please do not drive at rated current more than 5 sec. without proper heat sink
2. Blue power light sources represented here are IEC825 Class 2 for eye safety



3. Green

3-1 Electro-Optical characteristics at $I_F=350\text{mA}$, $T_A=25^\circ\text{C}$

Parameter	Symbol	Value			Unit
		Min	Typ	Max	
Luminous Flux [1]	Φ_V [2]	32	38	-	lm
Dominant Wavelength [3]	λ_D	523	533	540	nm
Forward Voltage [4]	V_F	3.0	3.5	4.0	V
View Angle [5]	2θ 1/2	130			deg.
Thermal Resistance [6]	$R\theta_{J-B}$	13			$^\circ\text{C} / \text{W}$

3-2 Absolute Maximum Ratings

Parameter	Symbol	Value	Unit
Forward Current	I_F	0.4	A
Power Dissipation	P_D	1.6	W
Junction Temperature	T_j	125	$^\circ\text{C}$
Operating Temperature	T_{opr}	-30 ~ +85	$^\circ\text{C}$
Storage Temperature	T_{stg}	-40 ~ +120	$^\circ\text{C}$
ESD Sensitivity [7]	-	$\pm 10,000\text{V}$ HBM	-

*Notes :

- [1] SSC maintains a tolerance of $\pm 10\%$ on flux and power measurements.
- [2] Φ_V is the total luminous flux output as measured with an integrated sphere.
- [3] Dominant wavelength is derived from the CIE 1931 Chromaticity diagram.
A tolerance of $\pm 1.0\text{nm}$ for dominant wavelength
- [4] A tolerance of $\pm 0.1\text{V}$ on forward voltage measurements
- [5] Viewing angle is the reference condition.
- [6] $R\theta_{J-B}$ is measured with a SSC metal core pcb. ($25^\circ\text{C} \leq T_j \leq 110^\circ\text{C}$)
Insulation voltage of Metal PCB is 6.5kVAC
- [7] It is included the zener chip to protect the product from ESD.
(bidirectional zener diode, $V_b = 5.6\text{V}$)

* Caution

1. Please do not drive at rated current more than 5 sec. without proper heat sink



4. Red

4-1 Electro-Optical characteristics at $I_F=350\text{mA}$, $T_A=25^\circ\text{C}$

Parameter	Symbol	Value			Unit
		Min	Typ	Max	
Luminous Flux [1]	Φ_V [2]	22	32	-	lm
Dominant Wavelength [3]	λ_D	617	622	629	nm
Forward Voltage [4]	V_F	2.0	2.5	3.0	V
View Angle [5]	2θ 1/2	130			deg.
Thermal Resistance [6]	$R\theta_{J-B}$	18			$^\circ\text{C}/\text{W}$

4-2 Absolute Maximum Ratings

Parameter	Symbol	Value	Unit
Forward Current	I_F	0.4	A
Power Dissipation	P_D	1.2	W
Junction Temperature	T_j	100	$^\circ\text{C}$
Operating Temperature	T_{opr}	-30 ~ +85	$^\circ\text{C}$
Storage Temperature	T_{stg}	-40 ~ +120	$^\circ\text{C}$
ESD Sensitivity [7]	-	$\pm 10,000\text{V}$ HBM	-

*Notes :

- [1] SSC maintains a tolerance of $\pm 10\%$ on flux and power measurements.
- [2] Φ_V is the total luminous flux output as measured with an integrated sphere.
- [3] Dominant wavelength is derived from the CIE 1931 Chromaticity diagram.
A tolerance of $\pm 1.0\text{nm}$ for dominant wavelength
- [4] A tolerance of $\pm 0.1\text{V}$ on forward voltage measurements
- [5] Viewing angle is the reference condition.
- [6] $R\theta_{J-B}$ is measured with a SSC metal core pcb. ($25^\circ\text{C} \leq T_j \leq 110^\circ\text{C}$)
Insulation voltage of Metal PCB is 6.5kVAC
- [7] It is included the zener chip to protect the product from ESD.
(bidirectional zener diode, $V_b = 5.6\text{V}$)

* Caution

1. Please do not drive at rated current more than 5 sec. without proper heat sink



1. White ($I_F=R:170, G:370, B:150$ mA for the reference condition)

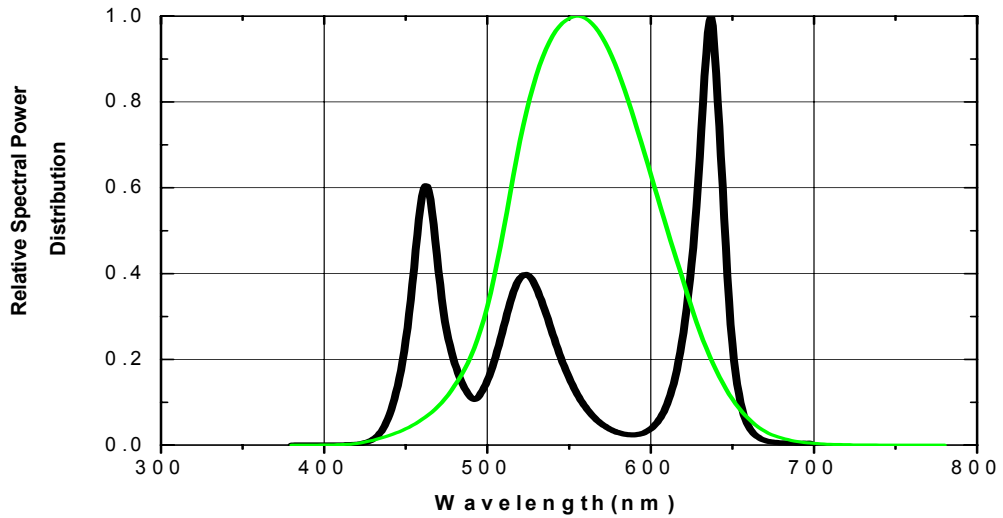

2. Blue ($I_F=350$ mA)

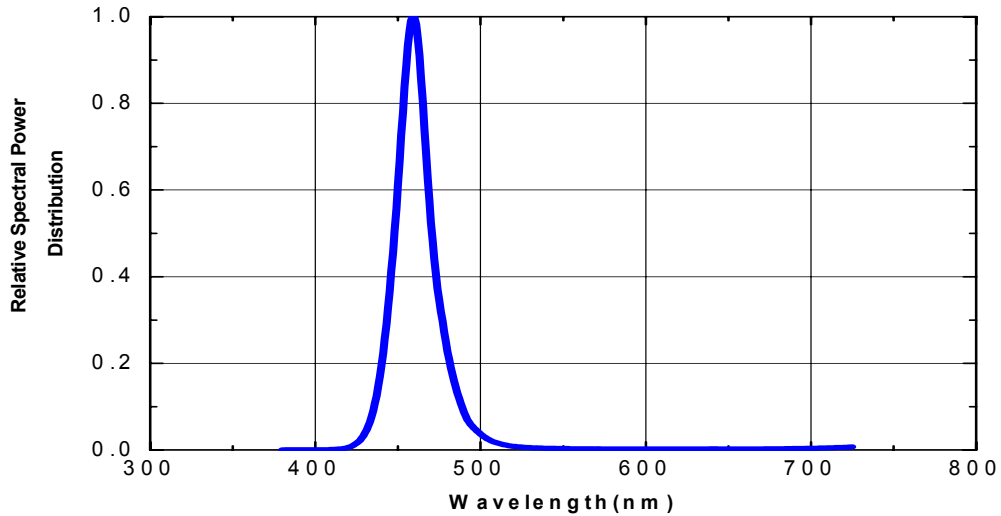

3. Green ($I_F=350\text{mA}$)

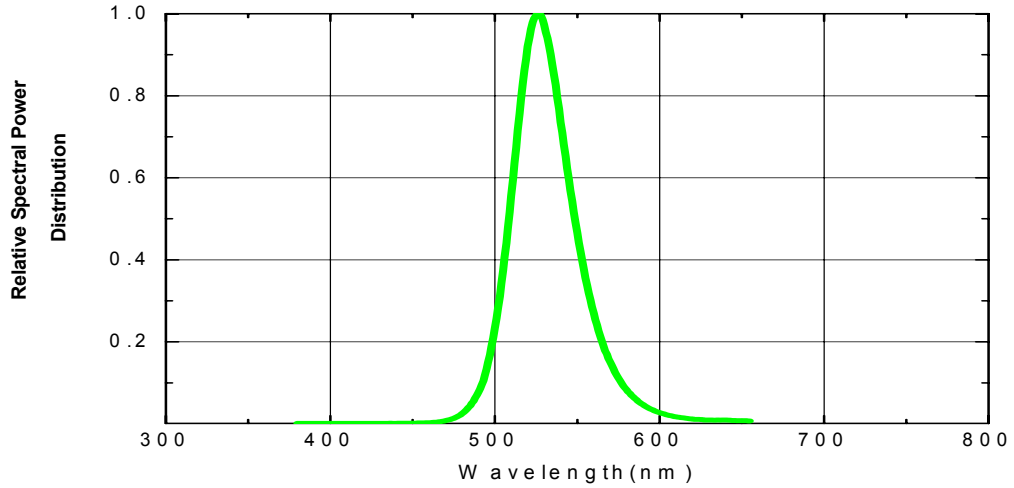

4. Red ($I_F=350\text{mA}$)

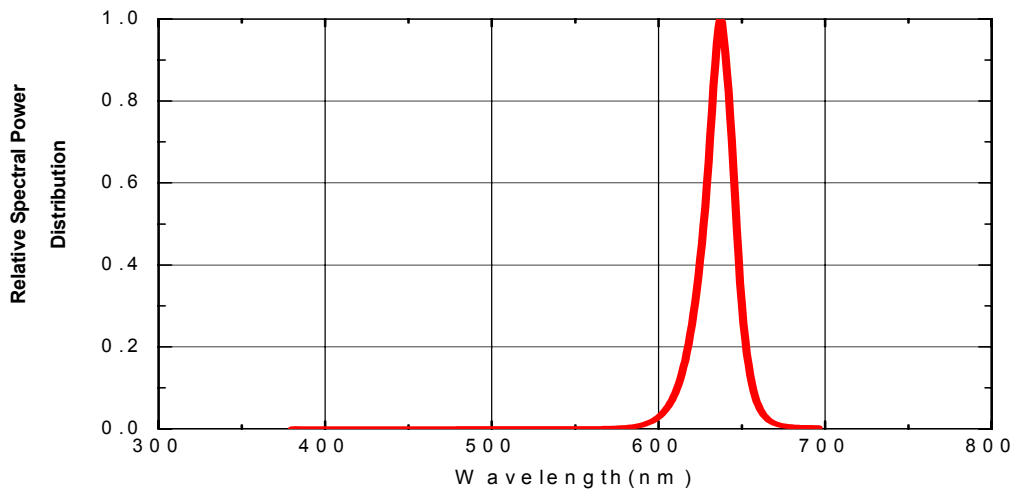

Light Output Characteristics

1. Relative Light Output vs. Junction Temperature at $I_F=350\text{mA}$, $T_A=25^\circ\text{C}$

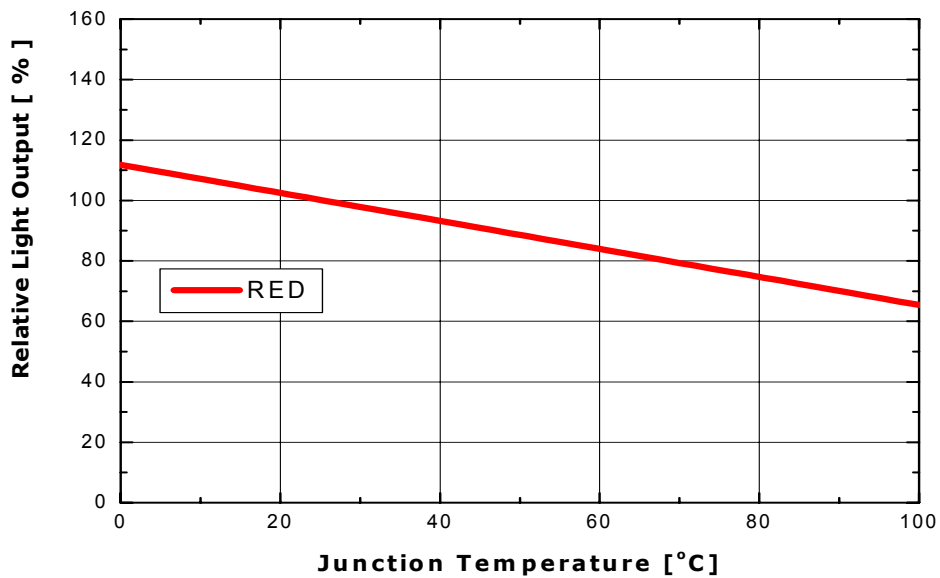
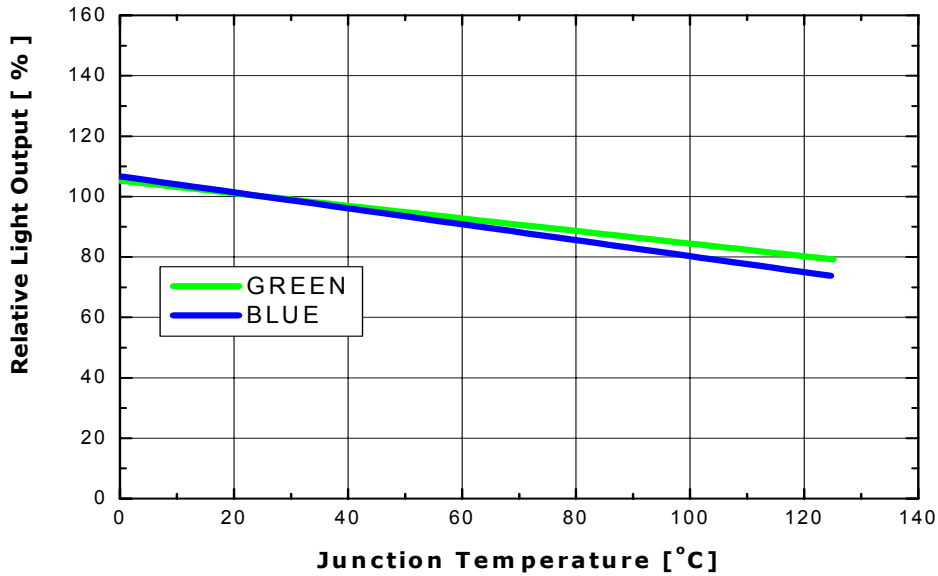

Forward Current Characteristics

1. Forward Voltage vs. Forward Current, $T_A=25^\circ\text{C}$

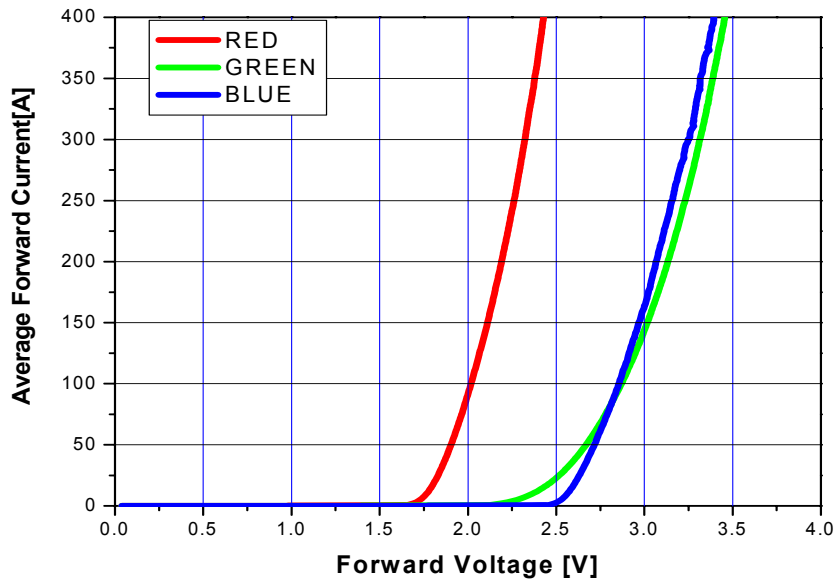

2. Forward Current vs. Normalized Relative Luminous Flux, $T_A=25^\circ\text{C}$

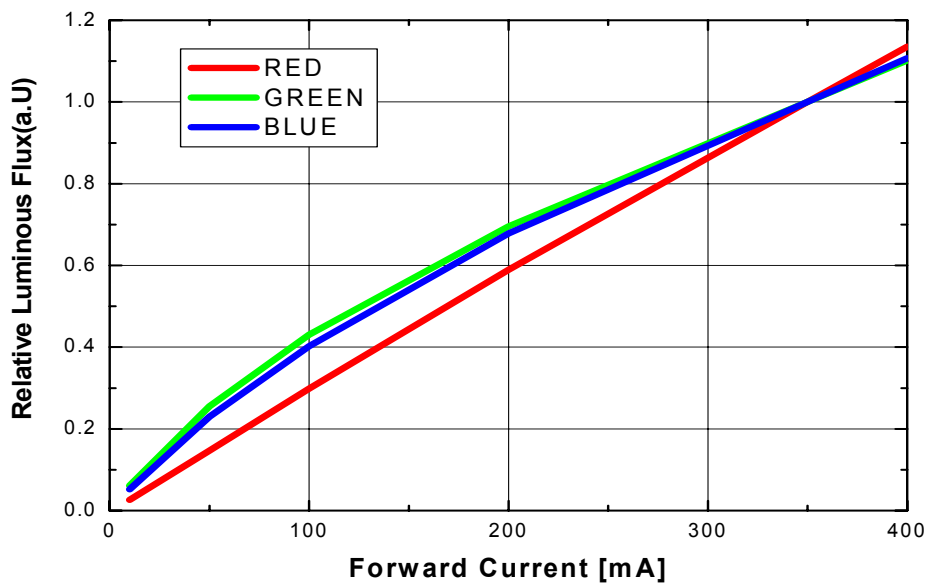

3. Forward Current Vs Wavelength shift, $T_A=25^\circ\text{C}$

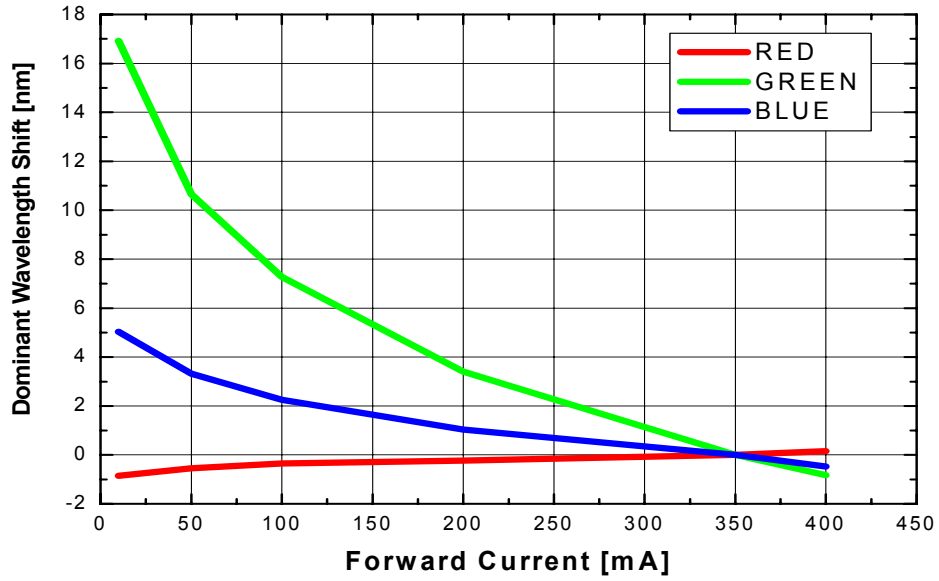

Ambient Temperature vs Allowable Forward Current

1. Blue, Green ($T_{JMAX} = 125\text{ }^{\circ}\text{C}$)

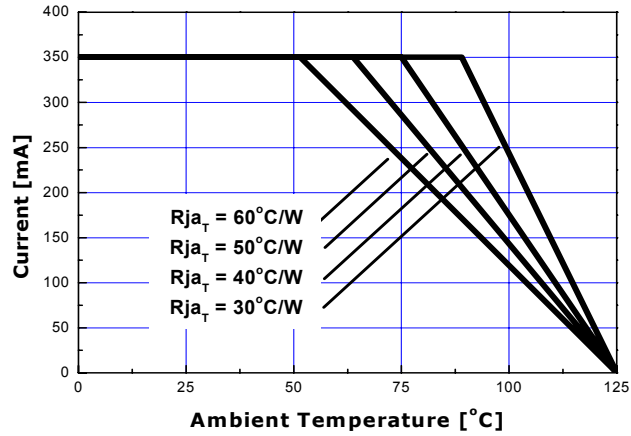

2. Red ($T_{JMAX} = 100\text{ }^{\circ}\text{C}$)

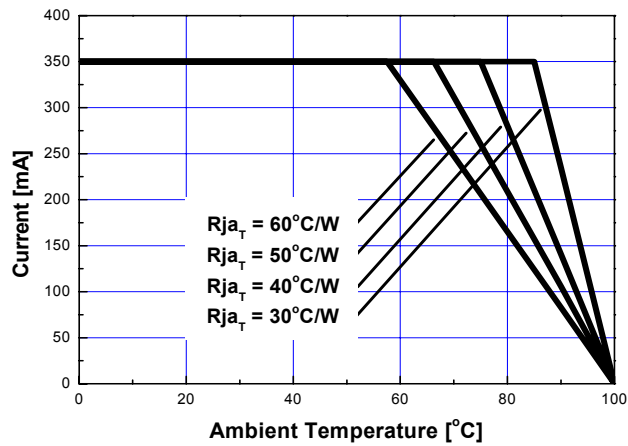

Typical Emitter Type Radiation pattern

1. White

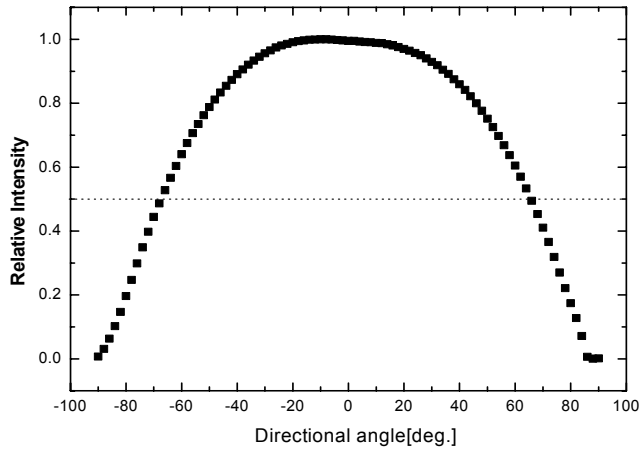

2. Blue, Red

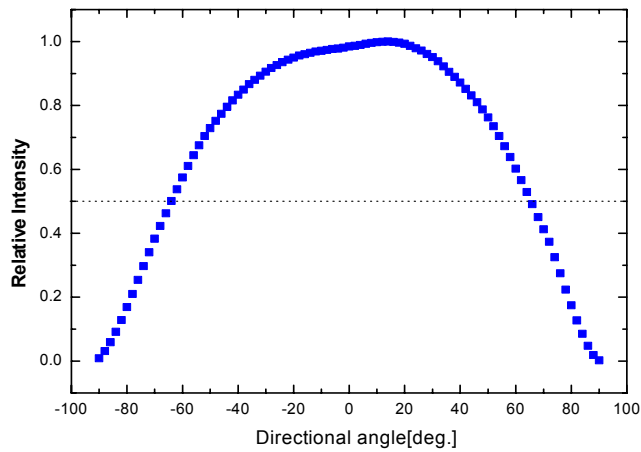

3. Green

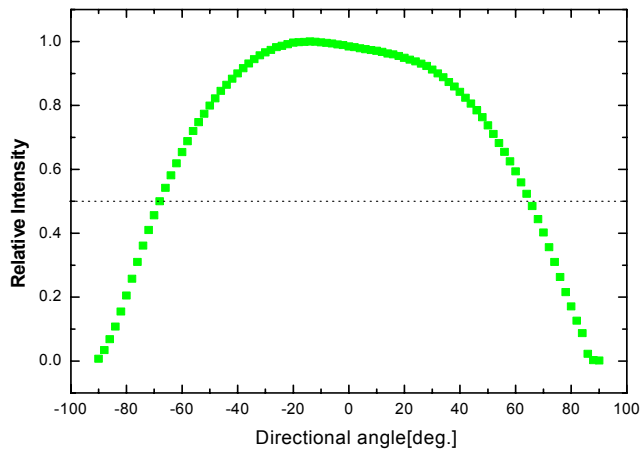

Rectangular Type Reel Packaging - Rectangular type

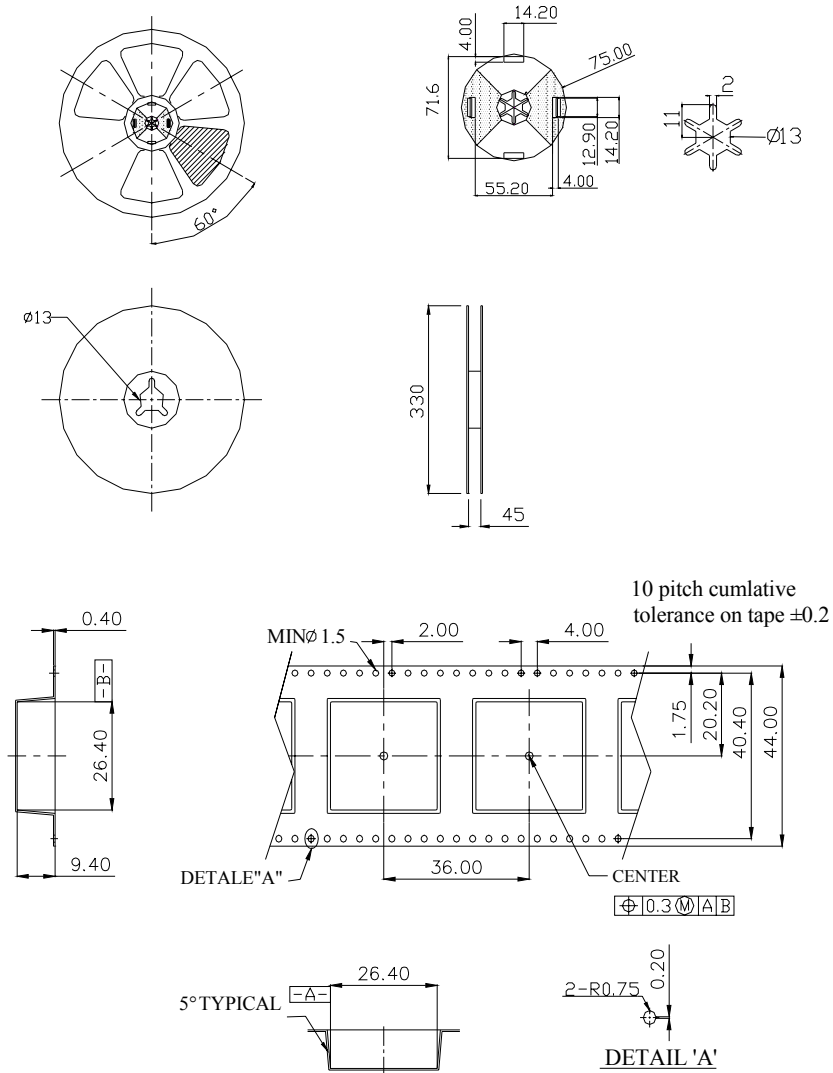

Note :

1. The number of loaded products in the reel is 100ea
2. All dimensions are in millimeters (tolerance : ± 0.2)
3. Scale none

*The appearance and specifications of the product may be changed for improvement without notice.

Precaution for use

- Storage
Avoid the absorption of moisture, we recommend to store Z Power LEDs in a dry box (or desiccators) with a desiccant . Otherwise, store them in the following environment:
Temperature : 5℃~30℃ Humidity : 50% max.
- Precaution after opening packaging
However LED is correspond SMD, when LED be soldered dip, interfacial separation may affect the light transmission efficiency, causing the light intensity to drop.
Attention in followed.
 - a. Soldering should be done right after opening the package(within 24Hrs).
 - b. Keeping of a fraction
 - Sealing
 - Temperature : 5 ~ 40℃ Humidity : less than 30%
 - c. If the package has been opened more than 1week or the color of desiccant changes, components should be dried for 10-12hr at 60±5℃
- Any mechanical force or any excess vibration shall not be accepted to apply during cooling process to normal temp. after soldering.
- Avoid quick cooling
- Components should not be mounted on warped direction of PCB.
- Anti radioactive ray design is not considered for the products listed here in.
- Gallium arsenide is used in some of the products listed in this publication. These products are dangerous if they are burned or smashed in the process of disposal. It is also dangerous to drink the liquid or inhale the gas generated by such products when chemically disposed.
- This device should not be used in any type of fluid such as water, oil, organic solvent and etc. When washing is required, IPA(Isopropyl Alcohol) should be used.
- When the LEDs are illuminating, operating current should be decided after considering the package maximum temperature.
- LEDs must be stored to maintain a clean atmosphere. If the LEDs are stored for 3 months or more after being shipped from SSC, a sealed container with a nitrogen atmosphere should be used for storage.
- The appearance and specifications of the product may be modified for improvement without notice.
- Long time exposure of sunlight or occasional UV exposure will cause reflector discoloration.
- Slug polarity is anode of Red chip.



Handling of Silicone resin LEDs

Z-Power LED is encapsulated by silicone resin for the highest flux efficiency.

Notes for handling of Silicone resin Z-Power LEDs

- Avoid touching silicone resin parts especially by sharp tools such as Pincette(Tweezers)
- Avoid leaving fingerprints on silicone resin parts.
- Since silicone resin is dust sensitive, Z POWER has to be stored on container with cover.
- When populating boards in SMT production, there are basically no restrictions regarding the form of the pick and place nozzle, except that mechanical pressure on the surface of the resin must be prevented.
- Covering silicone resin of Z POWER LED with other resin (epoxy, urethane, etc) is not recommended.

