

LTE MIMO Combination Antenna

JCG046LM

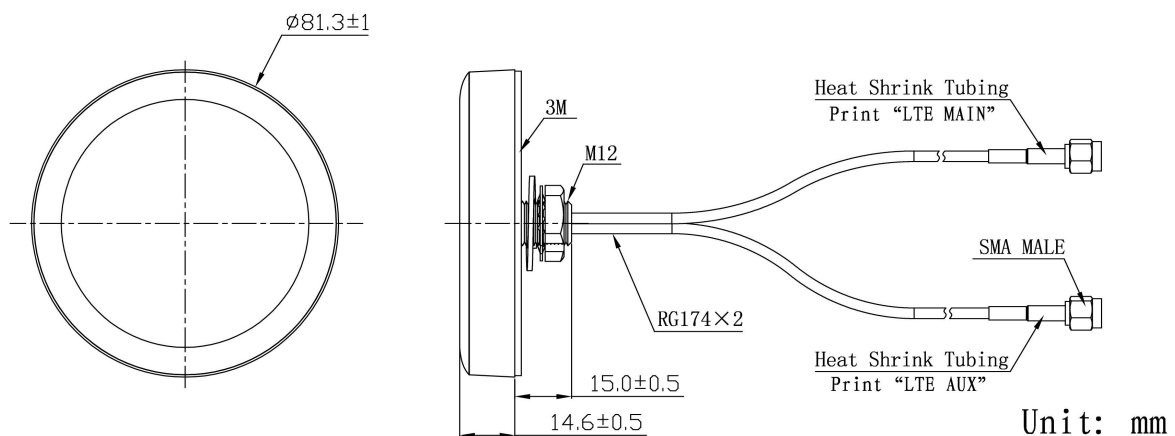

DIMENSIONS



JIAXING JINCHANG ELECTRONIC TECHNOLOGY CO.,LTD

Add: 398#, Zhenye Road, South Street, Jiaxing, Zhejiang, China

Http:// www.jinchanggps.com

E-mail: jcgps@vip.163.com

Tel: 86-0573-83692157/83692605/83958637 Fax: 86-0573-83958635

SPECIFICATIONS

Item	Specifications	
LTE Antenna MAIN	Frequency Range	698~960MHz/1710~2690MHz
	V.S.W.R	<3.0
	Polarization	Linear
	Gain	2.5dBi (Zenith)
	Impedance	50Ω
LTE Antenna AUX	Frequency Range	698~960MHz/1710~2690MHz
	V.S.W.R	<3.0
	Polarization	Linear
	Gain	2.0dBi (Zenith)
	Impedance	50Ω
Mechanical	Cable	RG174
	Connector	SMA or others
	Material	ABS
	Mounting Method	Screw
Environmental	Operating Temperature	-40℃~+85℃
	Relative Humidity	Up to 95%
	Ingress Protection	IP67(exclude cable outlet)
	Vibration	10 to 55Hz with 1.5mm amplitude 2hours
	Environmentally Friendly	ROHS Compliant

Radiation Pattern

LTE Antenna MAIN

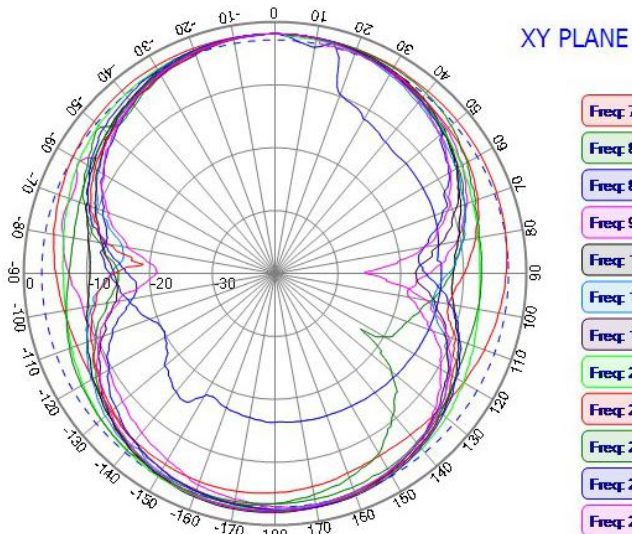

- Freq: 700
- Freq: 824
- Freq: 868
- Freq: 960
- Freq: 1710
- Freq: 1850
- Freq: 1990
- Freq: 2170
- Freq: 2300
- Freq: 2400
- Freq: 2500
- Freq: 2690

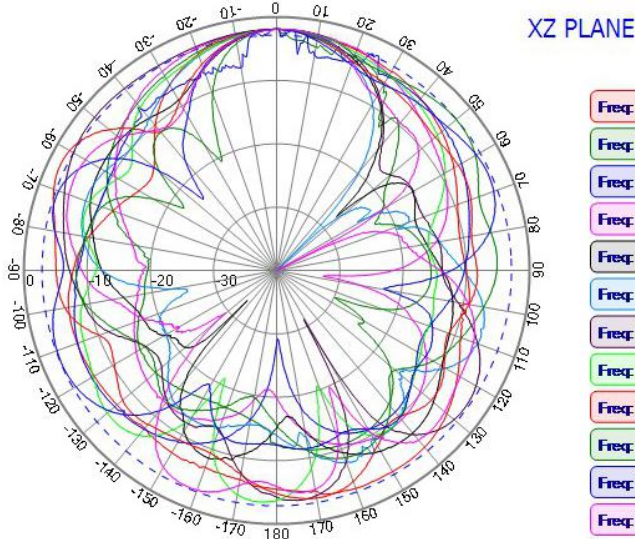

- Freq: 700
- Freq: 824
- Freq: 868
- Freq: 960
- Freq: 1710
- Freq: 1850
- Freq: 1990
- Freq: 2170
- Freq: 2300
- Freq: 2400
- Freq: 2500
- Freq: 2690

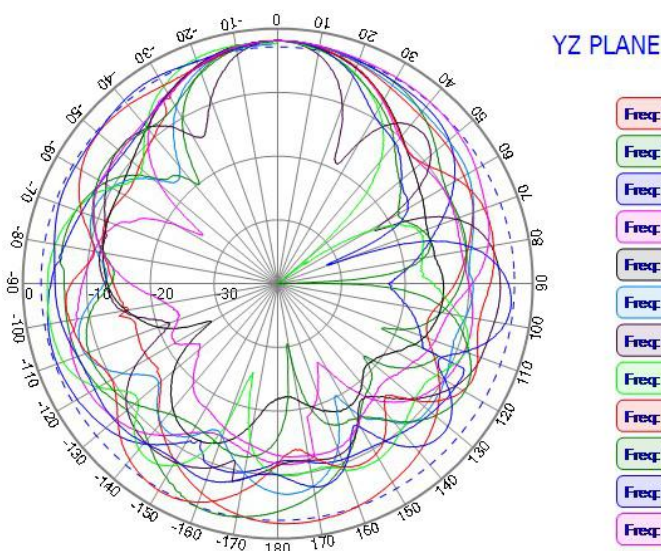

- Freq: 700
- Freq: 824
- Freq: 868
- Freq: 960
- Freq: 1710
- Freq: 1850
- Freq: 1990
- Freq: 2170
- Freq: 2300
- Freq: 2400
- Freq: 2500
- Freq: 2690

LTE Antenna AUX

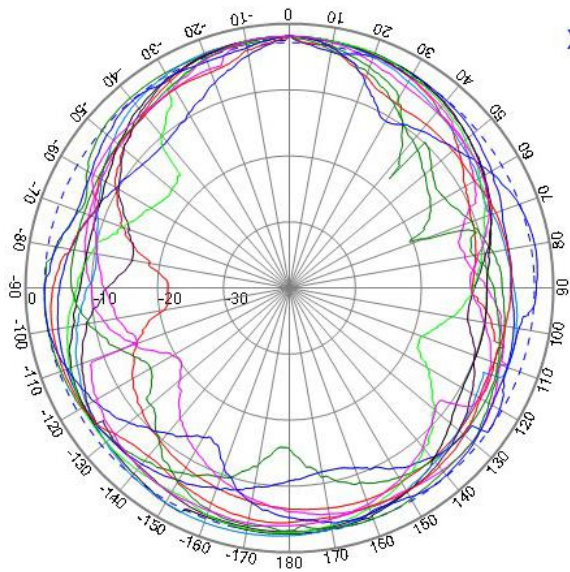

- Freq: 700
- Freq: 824
- Freq: 868
- Freq: 960
- Freq: 1710
- Freq: 1850
- Freq: 1990
- Freq: 2170
- Freq: 2300
- Freq: 2400
- Freq: 2500
- Freq: 2690

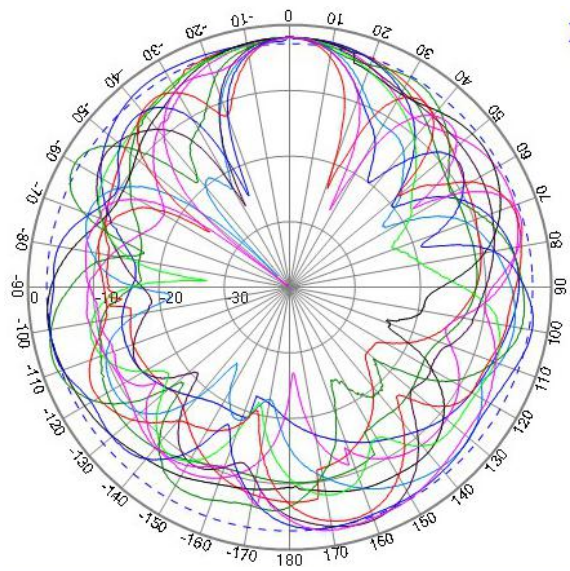

- Freq: 700
- Freq: 824
- Freq: 868
- Freq: 960
- Freq: 1710
- Freq: 1850
- Freq: 1990
- Freq: 2170
- Freq: 2300
- Freq: 2400
- Freq: 2500
- Freq: 2690

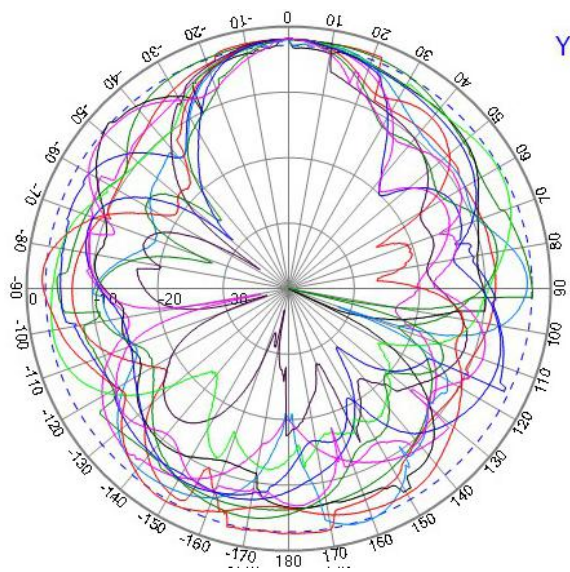

- Freq: 700
- Freq: 824
- Freq: 868
- Freq: 960
- Freq: 1710
- Freq: 1850
- Freq: 1990
- Freq: 2170
- Freq: 2300
- Freq: 2400
- Freq: 2500
- Freq: 2690