

Material:
* Insulation: Nylon 66, Color Nature

Ordering Code:

CP-01 ① ② ** ③ 0 ④ * ⑤ S ⑥

- ① Series No.
- ② Contact Type: 1= Receptacle
- ③ No of Circuits:
- ④ Plating Code: 0= Non plating
- ⑤ Variation: 1= UL 94V-2
3= UL 94V-0
- ⑥ Option: S= Single Row

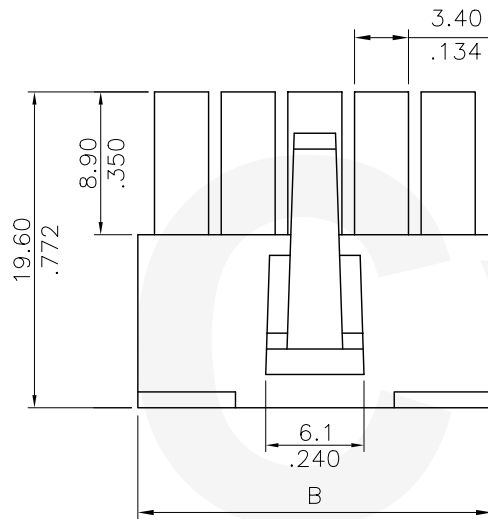

FOR 4 , 5 CIRCUITS

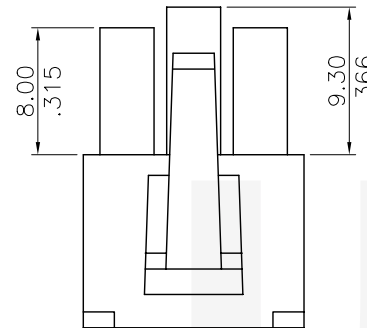
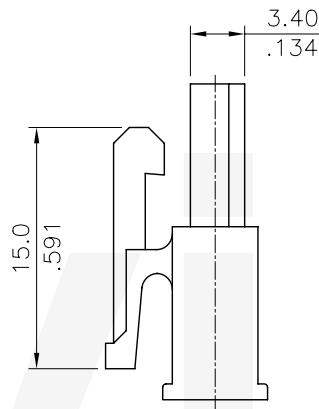

FOR 3 CIRCUITS

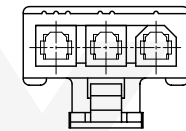

3 CIRCUITS

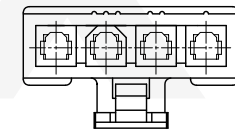

4 CIRCUITS

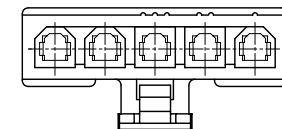

5 CIRCUITS

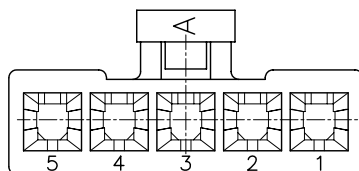

Circuits	Dimension	
	A	B
3	8.40(.331)	13.8(.543)
4	12.60(.496)	18.0(.709)
5	16.80(.661)	22.2(.874)

Halogen-Free

CIRCUIT PATTERN SCHEDULE

④					DATE	UNIT: mm / inch	TITLE: 4.20mm PICH RECEPTACLE CONN. (SINGLE ROW)
③					DRAWN BY: Eisley	04/07-03'	MATERIAL:
②					ENGINEER: David	04/07-03'	
①					CHECKED BY: David	04/07-03'	FINISH:
SYM	NAME	DATE	REVISIONS	APPROVED BY: Alex	04/07-03'		



DRAWING NO.	CP0178SA	PART NO.	CP-011**0*S
SCALE	2 / 1	SHEET	1 OF 1