

# CNY17-x

## Phototransistor Optocoupler High Collector-Emitter Voltage Type



### Data Sheet

#### Description

The CNY17 contains a light emitting diode optically coupled to a photo-transistor. It is packaged in a 6-pin DIP package and available in wide-lead spacing option and lead bend SMD option. Collector-emitter voltage is above 70 V. Response time,  $t_r$ , is typically 5  $\mu$ s and minimum CTR is 40% at input current of 10 mA.

#### Applications

- System appliances, measuring instruments
- Signal transmission between circuits of different potentials and impedances
- Feedback circuit in power supply

#### Functional Diagram



#### Features

- High collector-emitter voltage ( $V_{CE0} = 70$  V)
- High input-output isolation voltage ( $V_{iso} = 5000$  Vrms)
- Current Transfer Ratio (CTR: min. 40% at  $I_F = 10$  mA,  $V_{CE} = 5$  V)
- Response time ( $t_r$ : typ., 5  $\mu$ s at  $V_{CC} = 10$  V,  $I_C = 2$  mA,  $R_L = 100$   $\Omega$ )
- Dual-in-line package
- UL approved
- CSA approved
- IEC/EN/DIN EN 60747-5-2 approved
- Options available:
  - Leads with 0.4" (10.16 mm) spacing (W00)
  - Leads bend for surface mounting (300)
  - Tape and reel for SMD (500)
  - IEC/EN/DIN EN 60747-5-2 approvals (060)

#### Schematic



**CAUTION:** It is advised that normal static precautions be taken in handling and assembly of this component to prevent damage and/or degradation which may be induced by ESD.

**Ordering Information**

CNY17-x is UL Recognized with 5000 Vrms for 1 minute per UL1577 and is approved under CSA Component Acceptance Notice #5, File CA 88324.

| Part Number | RoHS Compliant Option |                |                 |                 | Package       | Surface Mount | Gull Wing | Tape & Reel | IEC/EN/DIN EN60747-5-2 | Quantity          |
|-------------|-----------------------|----------------|-----------------|-----------------|---------------|---------------|-----------|-------------|------------------------|-------------------|
|             | -1                    | -2             | -3              | -4              |               |               |           |             |                        |                   |
|             | 40% <CTR> 80%         | 63% <CTR> 125% | 100% <CTR> 200% | 160% <CTR> 320% |               |               |           |             |                        |                   |
| CNY17       | -000E                 | -000E          | -000E           | -000E           | 300 mil DIP-6 |               |           |             |                        | 65 pcs per tube   |
|             | -300E                 | -300E          | -300E           | -300E           | 300 mil DIP-6 | X             | X         |             |                        | 65 pcs per tube   |
|             | -500E                 | -500E          | -500E           | -500E           | 300 mil DIP-6 | X             | X         | X           |                        | 1000 pcs per reel |
|             | -060E                 | -060E          | -060E           | -060E           | 300 mil DIP-6 |               |           |             | X                      | 65 pcs per tube   |
|             | -360E                 | -360E          | -360E           | -360E           | 300 mil DIP-6 | X             | X         |             | X                      | 65 pcs per tube   |
|             | -560E                 | -560E          | -560E           | -560E           | 300 mil DIP-6 | X             | X         | X           | X                      | 1000 pcs per reel |
|             | -W00E                 | -W00E          | -W00E           | -W00E           | 400 mil DIP-6 |               |           |             |                        | 65 pcs per tube   |
|             | -W60E                 | -W60E          | -W60E           | -W60E           | 400 mil DIP-6 |               |           |             | X                      | 65 pcs per tube   |

To order, choose a part number from the part number column and combine with the desired option from the option column to form an order entry.

Example 1:

CNY17-1-360E to order product of 300 mil DIP-6 DC Gull Wing Surface Mount package in Tube packaging with 40%<CTR>80%, IEC/EN/DIN EN 60767-5-2 Safety Approval and RoHS compliant.

Example 2:

CNY17-2-W00E to order product of 400 mil DIP-6 DC in Tube packaging with 63%<CTR>125% and RoHS compliant.

Option datasheets are available. Contact your Avago sales representative or authorized distributor for information.

**Package Outline Drawings**  
**CNY17-X-000E**

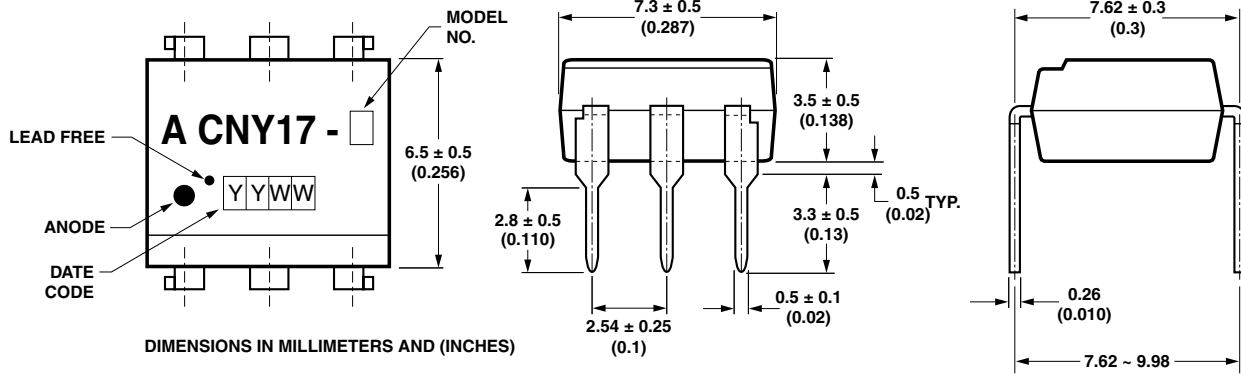

**CNY17-X-060E**

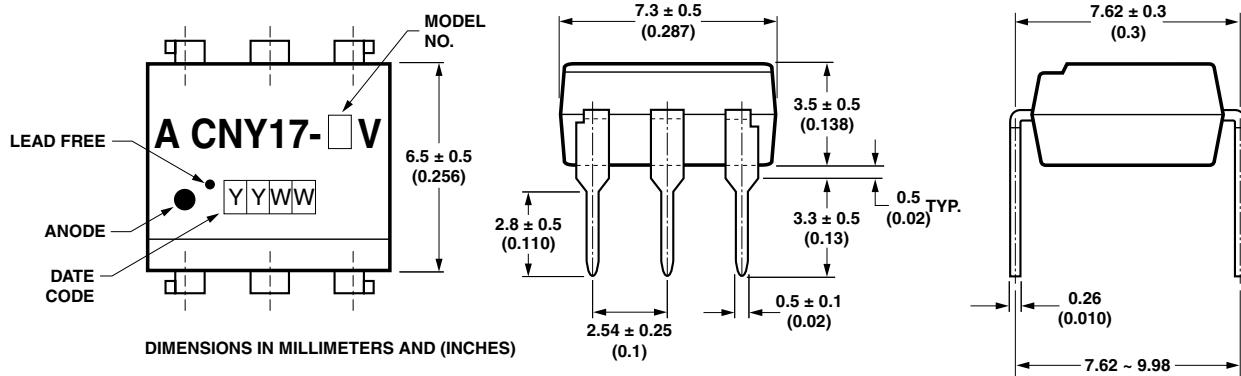

**CNY17-X-W00E**



**CNY17-X-300E**

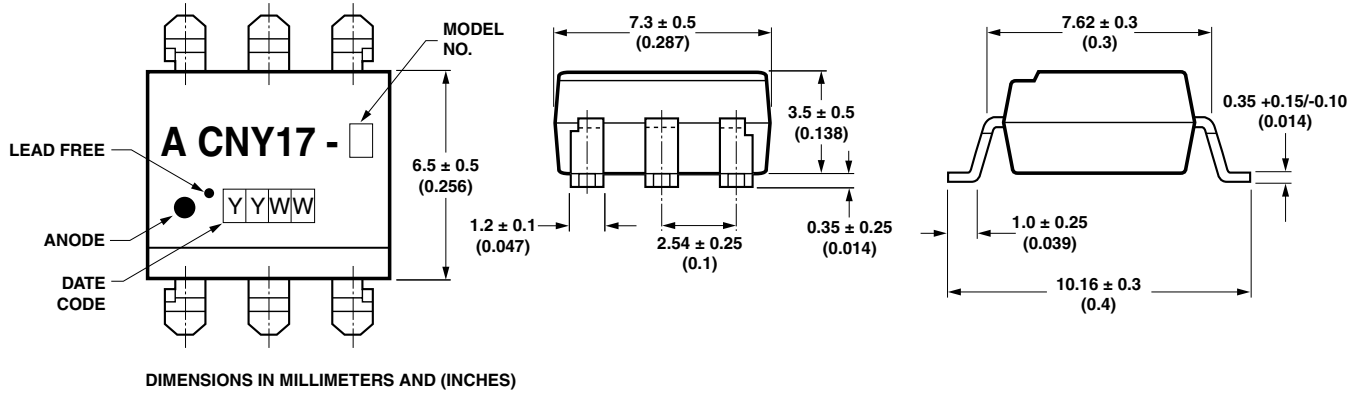

**Solder Reflow Temperature Profile**

- 1) One-time soldering reflow is recommended within the condition of temperature and time profile shown at right.
- 2) When using another soldering method such as infrared ray lamp, the temperature may rise partially in the mold of the device. Keep the temperature on the package of the device within the condition of (1) above.

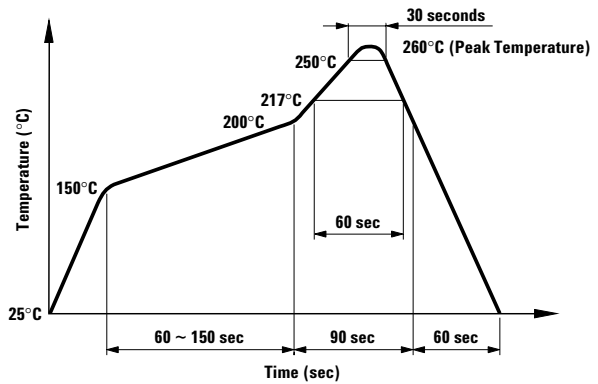

**Note: Non-halide flux should be used.**

**Absolute Maximum Ratings**

|  |                 |
|--|-----------------|
| Storage Temperature, $T_S$   | -55°C to +150°C |
| Operating Temperature, $T_A$                                       | -55°C to +100°C |
| Lead Solder Temperature, max.<br>(1.6 mm below seating plane)      | 260°C for 10 s  |
| Average Forward Current, $I_F$                                     | 60 mA           |
| Reverse Input Voltage, $V_R$                                       | 6 V             |
| Input Power Dissipation, $P_I$                                     | 100 mW          |
| Collector Current, $I_C$   | 150 mA          |
| Collector-Emitter Voltage, $V_{CE0}$                               | 70 V            |
| Emitter-Collector Voltage, $V_{EC0}$                               | 6 V             |
| Collector-Base Voltage, $V_{CB0}$                                  | 70 V            |
| Collector Power Dissipation  | 150 mW          |
| Total Power Dissipation  | 250 mW          |
| Isolation Voltage, $V_{ISO}$<br>(AC for 1 minute, R.H. = 40 ~ 60%) | 5000 Vrms       |

**Electrical Specifications (T<sub>A</sub> = 25°C)**

| Parameter                            | Symbol                                   | Min.                 | Typ.                   | Max.             | Units                   | Test Conditions                                 |
|--------------------------------------|--|----------------------|------------------------|------------------|-------------------------|---|
| Forward Voltage                      | V <sub>F</sub>                           | –                    | 1.4                    | 1.7              | V                       | I <sub>F</sub> = 60 mA                          |
| Reverse Current                      | I <sub>R</sub>                           | –                    | –                      | 10               | μA                      | V <sub>R</sub> = 6 V                            |
| Terminal Capacitance                 | C <sub>t</sub>                           | –                    | –                      | 100              | pF                      | V = 0, f = 1 MHz                                |
| Collector Dark Current               | I <sub>CEO</sub>                         | –                    | –                      | 50               | nA                      | V <sub>CE</sub> = 10 V                          |
| Collector-Emitter Breakdown Voltage  | BV <sub>CEO</sub>                        | 70                   | –                      | –                | V                       | I <sub>C</sub> = 0.1 mA, I <sub>F</sub> = 0     |
| Emitter-Collector Breakdown Voltage  | BV <sub>ECO</sub>                        | 6                    | –                      | –                | V                       | I <sub>E</sub> = 10 μA, I <sub>F</sub> = 0      |
| Collector-Base Breakdown Voltage     | BV <sub>CBO</sub>                        | 70                   | –                      | –                | V                       | I <sub>C</sub> = 0.1 mA, I <sub>F</sub> = 0     |
| Collector Current                    | I <sub>C</sub>                           | 4                    | –                      | 32               | mA                      | I <sub>F</sub> = 10 mA                          |
| *Current Transfer Ratio              | CNY17-1<br>CNY17-2<br>CNY17-3<br>CNY17-4 | CTR                  | 40<br>63<br>100<br>160 | –<br>–<br>–<br>– | 80<br>125<br>200<br>320 | %<br>V <sub>CE</sub> = 5 V                      |
| Collector-Emitter Saturation Voltage | V <sub>CE(sat)</sub>                     | –                    | –                      | 0.3              | V                       | I <sub>F</sub> = 10 mA, I <sub>C</sub> = 2.5 mA |
| Response Time (Rise)                 | t <sub>r</sub>                           | –                    | 5                      | 10               | μs                      | V <sub>CE</sub> = 5 V, I <sub>C</sub> = 10 mA   |
| Response Time (Fall)                 | t <sub>f</sub>                           | –                    | 5                      | 10               | μs                      | R <sub>L</sub> = 100 Ω                          |
| Isolation Resistance                 | R <sub>iso</sub>                         | 1 x 10 <sup>11</sup> | –                      | –                | Ω                       | DC 500 V<br>40 ~ 60% R.H.                       |
| Floating Capacitance                 | C <sub>f</sub>                           | –                    | –                      | 2                | pF                      | V = 0, f = 1 MHz                                |

\* CTR =  $\frac{I_C}{I_F} \times 100\%$



Figure 1. Forward current vs. temperature.

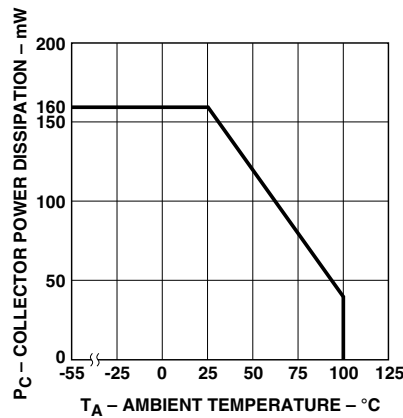

Figure 2. Collector power dissipation vs. temperature.

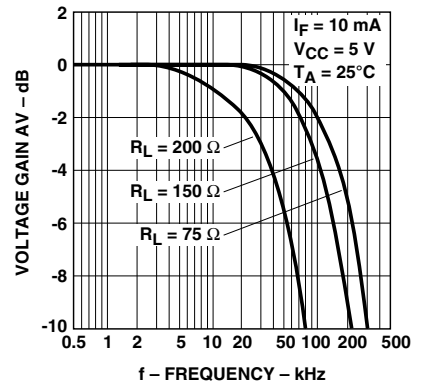

Figure 3. Frequency response.

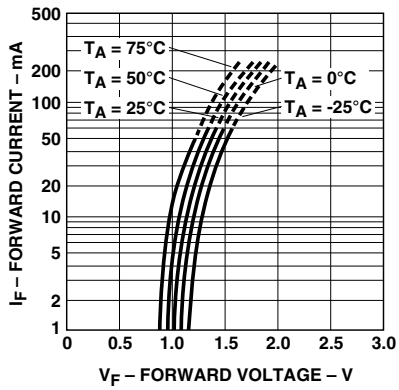

Figure 4. Forward current vs. forward voltage.

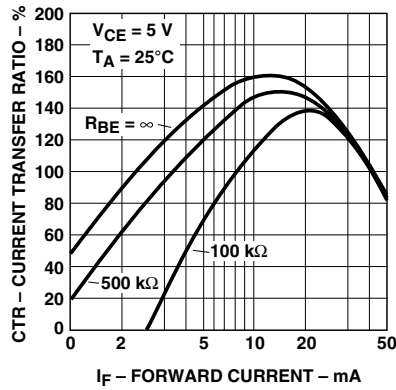

Figure 5. Current transfer ratio vs. forward current.

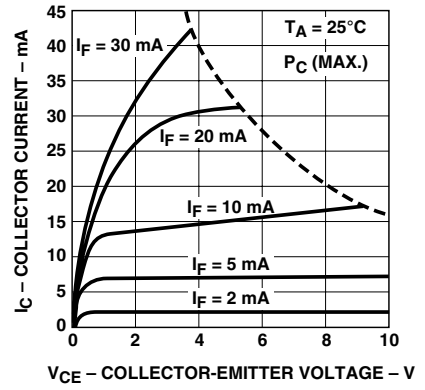

Figure 6. Collector current vs. collector-emitter voltage.

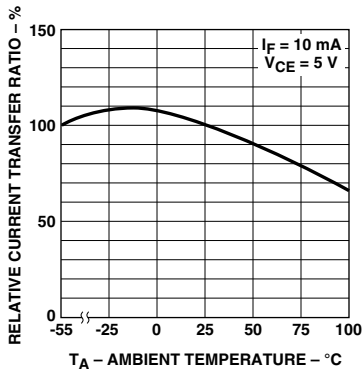

Figure 7. Relative current transfer ratio vs. temperature.

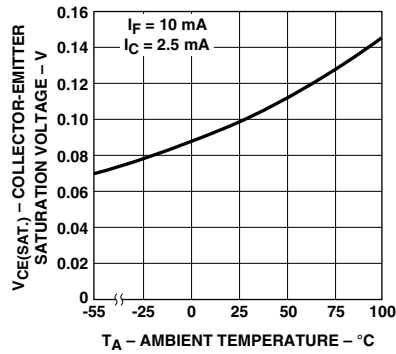

Figure 8. Collector-emitter saturation voltage vs. temperature.

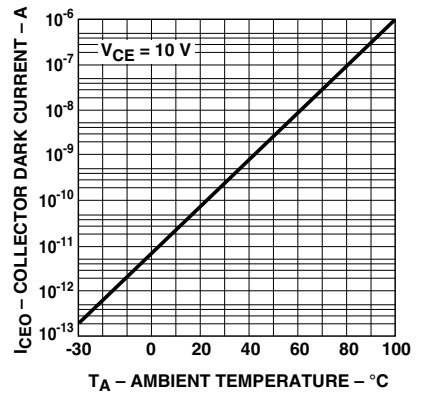

Figure 9. Collector dark current vs. temperature.

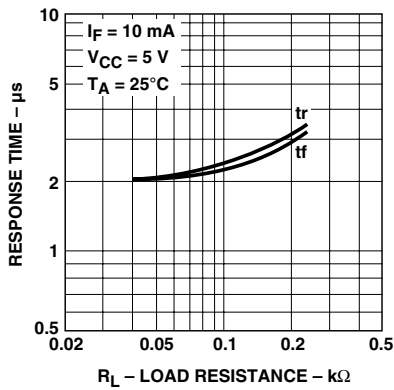

Figure 10. Response time vs. load resistance.

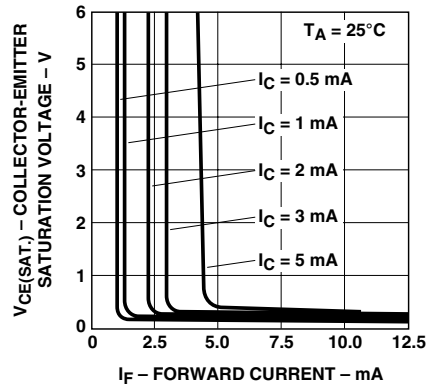
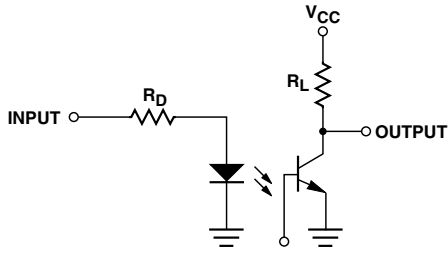
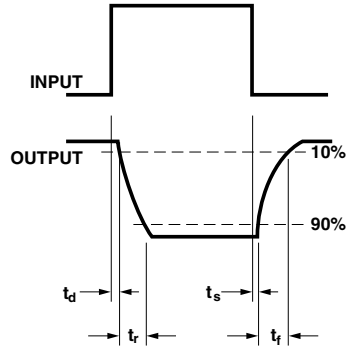
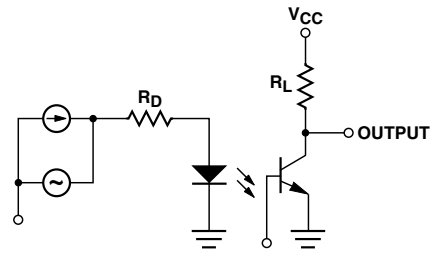

Figure 11. Collector-emitter saturation voltage vs. forward current.

### Test Circuit for Response Time



### Test Circuit for Frequency Response



For product information and a complete list of distributors, please go to our website: [www.avagotech.com](http://www.avagotech.com)

Avago, Avago Technologies, and the A logo are trademarks of Avago Technologies Limited in the United States and other countries. Data subject to change. Copyright © 2007 Avago Technologies Limited. All rights reserved. Obsoletes AV01-0536EN AV02-0772EN - October 18, 2007

