

Light is OSRAM

Slim Profile System

Slim Profile LF-LTS-2100

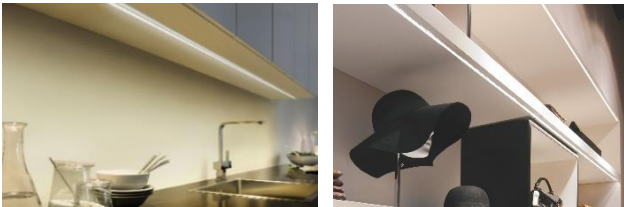

Features & Benefits

Powerful lighting in compact size. With reduced dimensions, this slim yet powerful profile is ideal for general illumination in confined spaces, such as coves.

Suitable for lighting up furniture, cabinets and shelves and for integration in plasterboards, for both decorative and general lighting solutions.

Application

- Architectural integration
- Cove lighting
- Shelves, Closets, Showcases, Cabinets Lighting
- Handrails and Stairs

Dimension & Available Covers



Slim profile LF-LTS-2100
Dimensions: W14.7 x H9.7 x L2100 mm

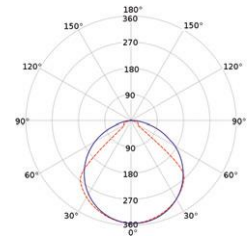
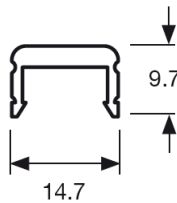

— C0-C180
— C90-C270
Profile without cover

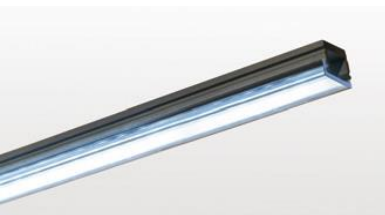

Clear cover LF-LTS-COVER-C
Dimensions: W17.7 x H5.3 x L2100 mm

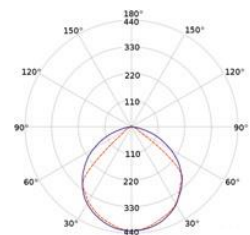
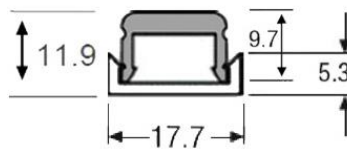

— C0-C180
— C90-C270
Clear cover



Diffuse cover LF-LTS-COVER-S
Dimensions: W17.7 x H10.5 x L2100 mm

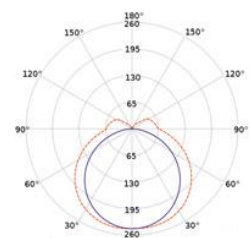
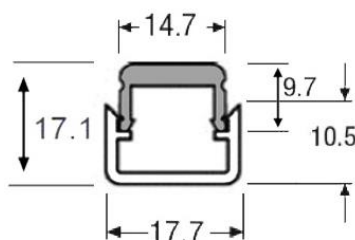

— C0-C180
— C90-C270
Diffuse cover S



Diffuse cover LF-LTS-COVER-D
Dimensions: W17.7 x H24 x L2100 mm

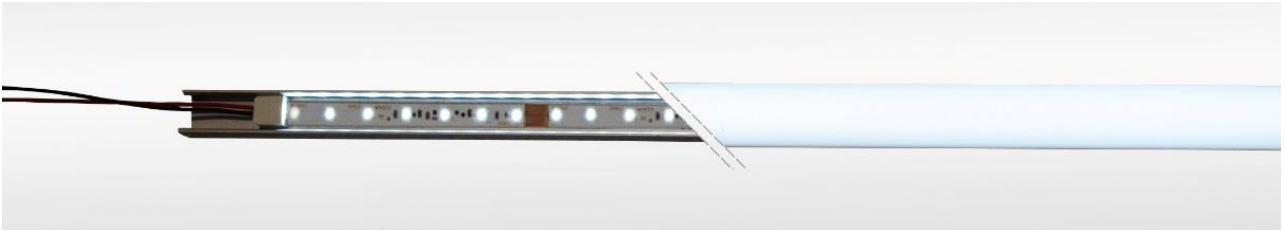
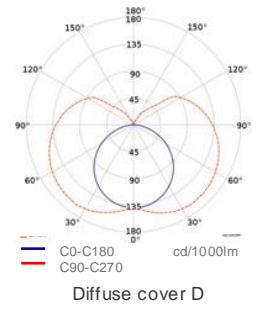
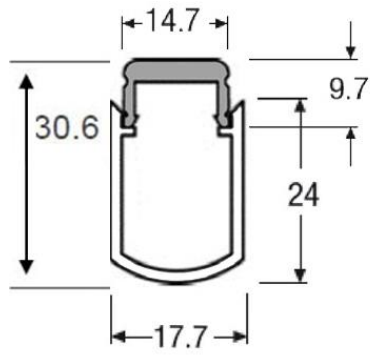

Slim Profile and strip LF1200 with and without diffuse cover D.

Electrical & Output data

Profile & LED Strip Compatibility									
LED Strip White IP00				LF500	LF800S	LF1200	LF2000	LF3000	LF4000
Color Temperature				Luminous Flux (lm/m) ¹					
●	820	2000 K	White	-	-	850	1402	2125	-
●	822	2200 K	White	374	629	-	-	-	-
●	824	2400 K	White	-	-	1020	1700	2550	-
●	825	2500 K	White	408	680	-	-	-	-
●	827	2700 K	White	408	680	1020	1700	2550	3187
●	830	3000 K	White	442	680	1020	1700	2550	3187
●	835	3500 K	White	442	680	-	-	-	-
○	840	4000 K	White	442	680	1020	1700	2550	3272
○	850	5000 K	White	-	-	1020	1700	2550	3272
○	865	6500 K	White	442	680	1020	1700	2550	3272
●	CRI 90 922	2200 K	White	306	467	-	-	-	-
●	CRI 90 927	2700 K	White	340	527	935	1530	2295	-
●	CRI 90 930	3000 K	White	340	527	1020	1700	2550	-
●	CRI 90 935	3500 K	White	374	578	-	-	-	-
○	CRI 90 940	4000 K	White	374	578	1020	1700	2550	-
○	CRI 90 965	6500 K	White	374	578	-	-	-	-

LED Strip Special White IP00				LF1200 SW	LF1200 TW	LF2000 SW	LF2000 TW	LF3000 SW	LF3000 TW**	LF3000 TWW
Color Temperature				Luminous Flux (lm/m) ¹						
●	CRI 90 930	3000 K	White	1020	-	1700	-	2550	-	-
○	CRI 90 940	4000 K	White	1020	-	1700	-	2550	-	-
●	TW	2700 - 6500 K	Dynamic White	-	1020	-	1700	-	2550	-
●	TWW	2200/2500-6500 K	Dynamic White	-	-	-	-	-	-	2550

LED Strip Color IP00				LF05A2	LF200C	LF05CE	LF05CA2	LF700RGBW	LF71300RGBW
Color Wave length				Luminous Flux (lm/m) ¹					
●	R	625	Red	102	-	-	-	-	-
●	G	525	Green	153	-	-	-	-	-
●	B	467	Blue	68	-	-	-	-	-
●	Y	587	Yellow	93	-	-	-	-	-
●	O	602	Orange	110	-	-	-	-	-
●	RGB	RGB	RGB	-	178	153	399	-	-
●	RGBW	RGBW	RGBW	-	-	-	-	592*	1099*

*Both channels RGB and White on

Profile & LED Strip Compatibility												
LED Strip White IP67				LFP500	LFP800S	LFP800	LFP1200	LFP1200 SW	LFP2000	LFP2000 SW	LFP3000**	LFP3000 SW**
Color Temperature				Luminous Flux (lm/m) ¹								
●	824	2400 K	White	-	-	680	935	-	1530	-	2380	-
●	827	2700 K	White	374	629	680	977	-	1615	-	2550	-
●	830	3000 K	White	408	680	-	1020	-	1615	-	2550	-
●	835	3500 K	White	408	680	-	-	-	-	-	-	-
○	840	4000 K	White	442	680	-	1020	-	1615	-	2550	-
○	860	6000 K	White	-	-	-	935	-	1530	-	2380	-
○	865	6500 K	White	442	680	-	-	-	-	-	-	-
●	CRI 90 927	2700 K	White	306	467	-	-	-	-	-	-	-
●	CRI 90 930	3000 K	White	-	-	-	935	-	1530	-	2422	-
●	CRI 90 935	3500 K	White	340	527	-	-	-	-	-	-	-
○	CRI 90 940	4000 K	White	340	527	-	1020	1020	1615	1530	2550	2380
○	CRI 90 960	5800 K	White	-	-	-	1020	-	1615	-	2550	-
○	CRI 90 965	6500 K	White	340	578	-	-	-	-	-	-	-



LED Strip Color IP67				LF05A-B3-P	LFP200C	LF05CE-P	LF05CA-P
Color Wave length				Luminous Flux (lm/m) ¹			
●	B	467	Blue	68	-	-	-
●	RGB	RGB	RGB	-	178	153	399

¹ Luminous flux comprehensive of the track's efficiency without cover (Light Output Ratio 85%).

Note: -10 % with clear cover, -45% with diffuse cover S, -38% with diffuse cover D.

** Only surface mounting allowed.

Thermal compatibility

IP00 LED strip	White & Special White					Tunable White				Color		
	LF500 LF800S	LF1200 LF1200 SW	LF2000 LF2000 SW	LF3000 LF3000 SW	LF4000	LF1200 TW	LF2000 TW	LF3000 TW	LF3000 TWW	LF05A2 LF05CA2 LF05CE LF200C	LF700 RGBW	LF1300 RGBW
Mounting condition	Maximum Ambient Temperature °C											
 Surface mounting	50	50	50	30	30	50	50	30	30	50	50	45
 Recessed mounting	50	50	37	27	27	50	35	-	25	50	50	40

IP67 LED strip	White & Special White				Color	
	LFP500 LFP800S	LFP800 LFP1200 LFP1200SW	LFP2000 LFP2000SW	LFP3000 LFP3000SW	LF05A-P LF05CE-P LFP200C	LF05CA-P
Mounting condition	Maximum Ambient Temperature °C					
 Surface mounting	50	50	40	27	50	40
 Recessed mounting	50	50	35	-	50	35





The tables report the maximum recommended ambient temperature for the Slim Profile in combination with IP00 and IP67 LED strips in case of surface or recessed mounting condition. In these conditions the expected Tc of LED strip is the maximum allowed.

Note: the table is for application evaluation only; always ensure that Tc do not exceed the maximum allowed value.

For further information contact our support service at flex-support@osram.com

Visibility of LED spots

IP00 LED strip	White & Special White				Tunable White		Color	
	LF500	LF800S	LF1200 LF2000 LF3000	LF1200SW LF2000SW LF3000SW	LF1200TW LF2000TW LF3000TW LF3000TWW	LF05A2 LF05CA2 LF05CE LF200C	LF700RGBW	LF1300RGBW
Covers	Maximum Ambient Temperature °C							
Clear cover LF-LTS-COVER-C	●	●	●	●	●	●	●	●
Diffuse Cover S LF-LTS-COVER-S	●					●	●	
Diffuse Cover D LF-LTS-COVER-D								

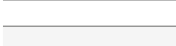
IP67 LED strip	White & Special White				Color		  
	LFP500	LFP800S	LFP1200 LFP2000 LFP3000	LFP1200SW LFP2000SW LFP3000SW	LF05CA-P LF05CE-P LFP200C	LF05A-P	
Covers	Maximum Ambient Temperature °C						
Clear cover LF-LTS-COVER-C	●	●	●	●	●	●	
Diffuse Cover S LF-LTS-COVER-S	●				●	●	
Diffuse Cover D LF-LTS-COVER-D							

LINEARlight FLEX® LED strips in system combination with profiles and covers – Visibility of LED spots.

Front view from observing point < 1.5m, size: not to scale

Technical drawings

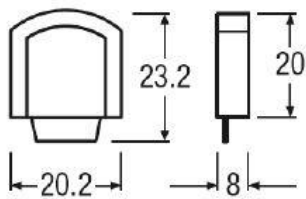
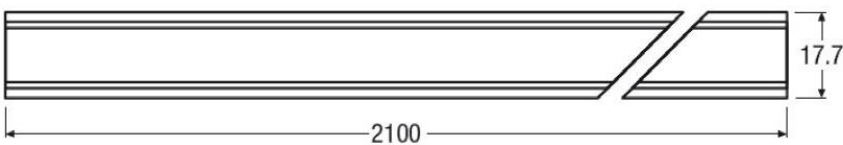
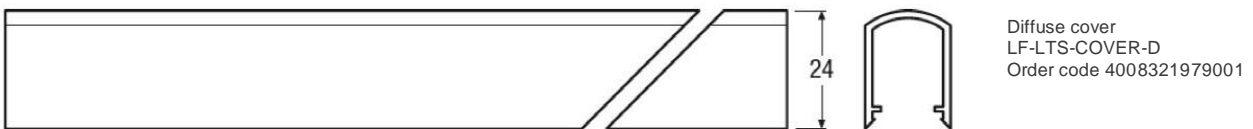
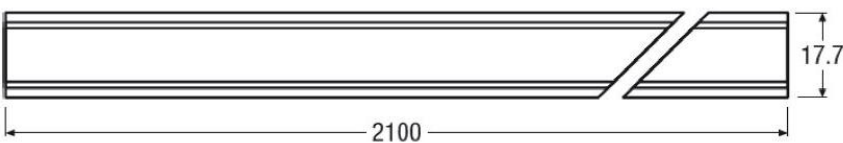
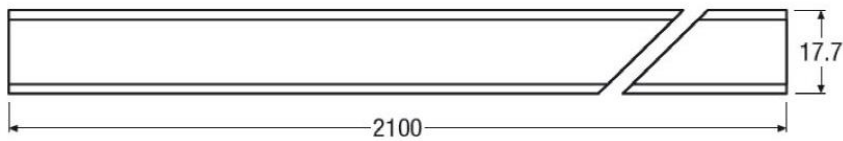
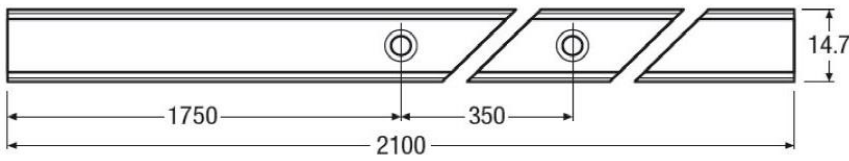

Silicon end cap for LF-LTS-COVER-D
LF-LTS-ENDCAP
Order code 4052899387591

Clear cover
LF-LTS-COVER-C

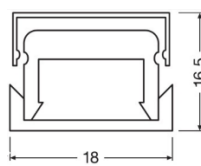

Diffuse cover
LF-LTS-COVER-S

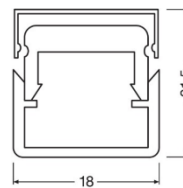

Diffuse cover
LF-LTS-COVER-D

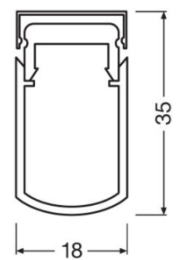

Plastic mounting bracket
LF-LTS-MB
Order code 4008321979025

Track System Order Code

Product Code	Description	Product number (EAN10)	Dimensions (length x width x height)	EAN Package content
LF-LTS-2100	Slim Track	4008321978981	2100 x 14.6 x 9.2 mm	40x Profile
LF-LTS-COVER-C	Clear Cover	4008321790187	2100 x 17.7 x 5.3 mm	40x Cover
LF-LTS-COVER-S	Diffuse Cover S	4008321790200	2100 x 17.7 x 10.5 mm	40x Cover
LF-LTS-COVER-D	Diffuse Cover D	4008321979001	2100 x 17.7 x 24 mm	40x Cover
LF-LTS-ENDCAP	Endcap for LF-LTS-COVER-D	4052899387591	20 x 20 x 8 mm	35x End cap
LF-LTS-MB	Mounting bracket	4008321979025	35 x 16 x 4.4 mm	20x Mounting bracket

Complete System Example

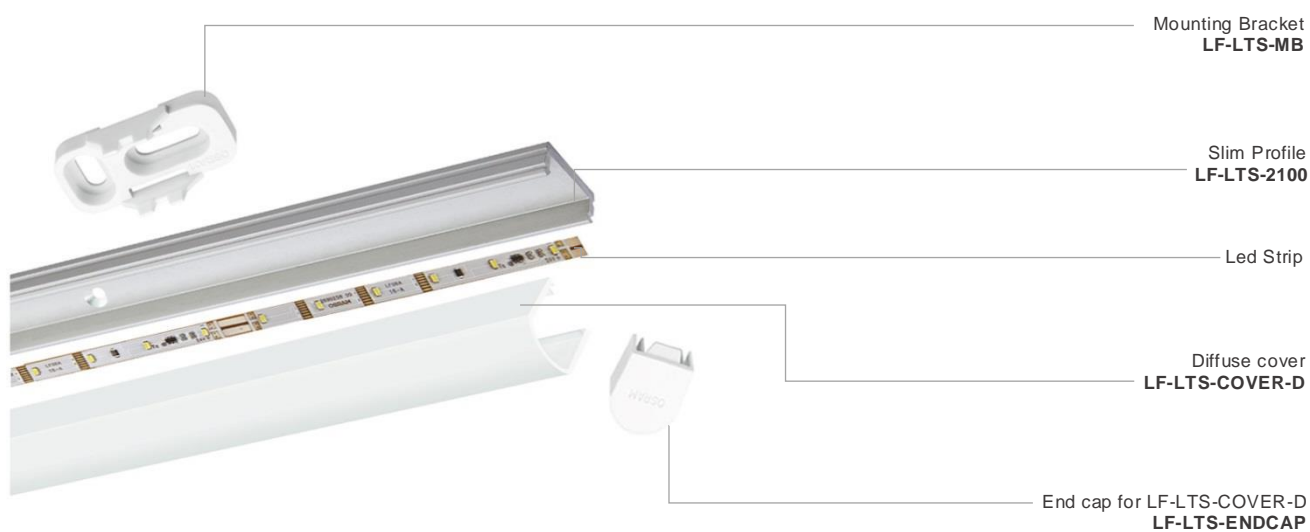

For further information please write to flex-support@osram.com or consult our Flex Configurator at www.osram.com/flex-configurator

Disclaimer

Subject to change without notice. Errors and omission excepted. Always make sure to use the most recent release.

OSRAM GmbH

Head Office:

Marcel-Breuer-Strasse 6
 80807 Munich, Germany
 Phone +49 89 6213-0
 Fax +49 89 6213-2020
www.osram.com

