

ATTEN

GT-2010 USB Soldering Iron User Manual

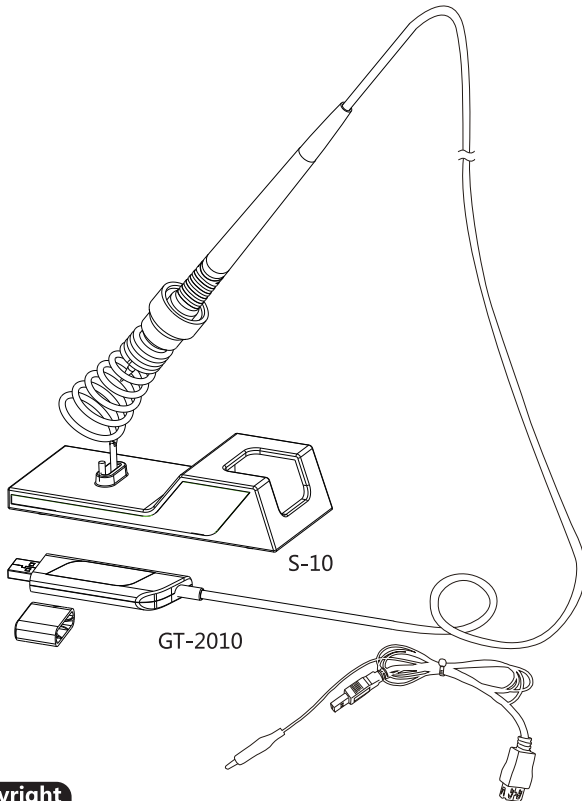

Copyright

The design of this product (including internal software) and the accessories are protected by relevant laws of China. Any violation of relevant rights of our company will be subject to legal sanction. Please abide by relevant national laws when you use this product.

Essentials

User should have basic knowledge of life and basic electrical operation before using the product. Underage user can only use this product under the guidance of a professional or guardian.

[Note] In order to avoid damage to the machine and keep the operating environment safe: Please read this Manual carefully before using this product, and keep it properly for future reference.

Safety Cautions

You must observe the following basic measures while using this machine to avoid electric shock, bodily injury, fire or other hazards. In order to ensure personal safety, only the parts and accessories accepted or recommended by the original manufacturer can be used, otherwise it will lead to serious consequences! Rework can only be carried out by qualified electrician or personnel designated by the factory!

[Note] This product uses low-voltage 5V DC power supply. In order to ensure electrical safety and normal use of the product, please abide by the technical specification of the product, and make sure that the maximum input voltage must not be greater than 5.5V DC.

[WARNING] The tip of soldering iron can reach a high temperature to 150-450°C when the product and original soldering iron accessories are working. Since the unreasonable operation may cause burn injury to the user or lead to a fire, please strictly observe the following issues:

- Do not touch the soldering tip and surrounding metal parts until the tip is completely cooled.
- DO not use this product near flammable substances.
- Please turn off the power switch when it is temporarily not in use or when stop the operation.
- When replacing the components and soldering tip, turn off the power. You can only operate when the equipment is completely cooled.
- When the operator has no experience or necessary knowledge, or when the preparation is insufficient, the operator shall not use this product in the absence of relevant personnel guidance.
- Keep this product away from children.
- Please exhaust the fume generated during welding process properly;
- Do not place the product or its components into water or operate with wet hands.
- Do not play when using this equipment. Such behavior is prone to cause damage to others or yourself.

Product Overview:

GT2010 USB Soldering Iron is especially suitable for precision soldering, which can disassemble small components flexibly. It's applicable to universities, research institutes, enterprise laboratories and other fields.

Features:

- Contact temperature sensor design, making its temperature more sensitive and accurate.
- 3 sets of shortcut temperature for option, making it work more convenient.
- Automatic detection of working status and auto sleep function can help to save energy.
- Its handle wire was made of silica gel, which has high temperature resistance and winding preventing.
- Exchangeable integrated heater with multiple sizes for option.

Specification:

Rated Power:	10W (5V Input)
Rated Voltage:	DC 5V±10%
Temperature range:	150°C~450°C (302°F~842°F)
Temperature accuracy :	±8°C(Room temperature 25°C)
Setting mode:	Button operate
Heater:	10W T10Integrated heater
Host Dimensions:	93.7 (L) ×26 (W) ×10.4 (H) mm
N.W.:	About 20g
Operative tips :	T10 Series soldering tips

Disclaimer

The company assumes no liability for personal injury or property loss arising from failure to follow relevant instructions, natural disasters and other force majeure or personal failures or other failures other than product nonconformity. This Manual is collated, compiled and issued by ATTEN according to the latest product features. The product and this Manual may be subject to subsequent updating without prior notice.

Packing

GT-2010 Soldering Iron	1pc
S-10 Soldering iron stand	1pc
User Manual	1 copy
C of C	1 copy
USB transfer cable	1pc

Interface description

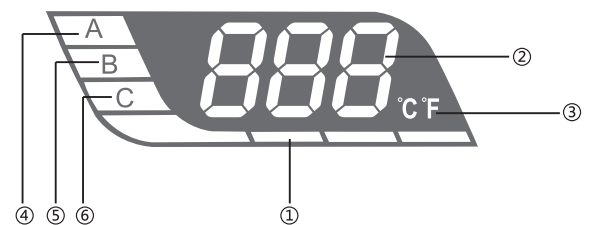

- ① Heating power bar indicates the heating status.
- ② When the temperature display area is working normally, it displays current real-time temperature.
- ③ Temperature unit
- ④ A indicates quick setting temperature A (factory default value is 300 °C)
- ⑤ B indicates quick setting temperature B (factory default value is 350 °C)
- ⑥ C indicates quick setting temperature C (factory default value is 400 °C)

Main interface

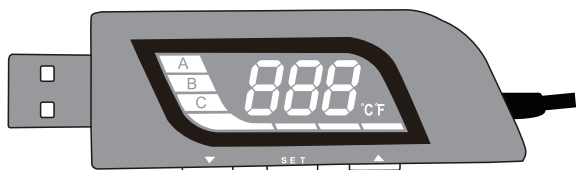

The interface will be fully displayed (about 1s)

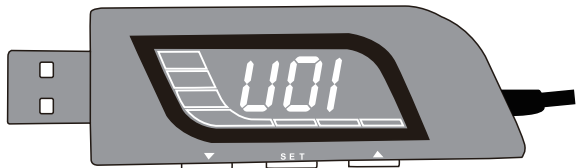

Firmware version number interface Start up, after display the firmware version number interface (about 1s), it will turn to normal operation condition which means that the Auto sleep function is not on.

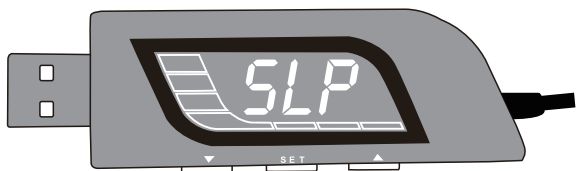

SLP Auto sleep function Start up, after display the firmware version number interface (about 1s), it will show SLP which means that the Auto sleep function is on.

Normal operation status

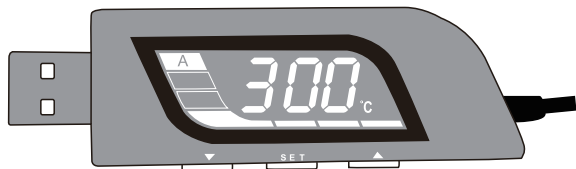

Normal work mode
(Enable the A/B/C short-cut temperature setting)

Setting temperature

There are two methods optional to change the setting temperature in normal working mode.

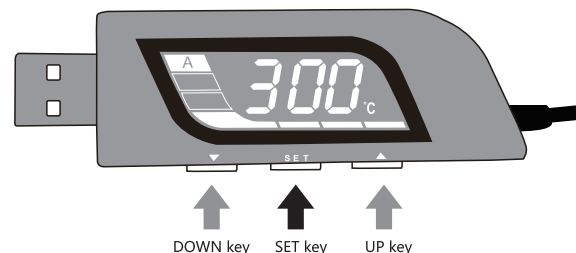

1 Enable to change the storage temperature with SET key; short press the SET key.

A/B/C quick temperature values will be called in turn. In addition, the group tag A/B/C will flash to show current storage group.

2 Set the temperature with the UP/DOWN key:
Short press the UP/DOWN key to decrease or increase a temperature unit.
Long press the UP/DOWN key to decrease or increase 10 temperature units.

The currently used shortcut group tag A/B/C will flash.

If no key is pressed in three seconds, the current short-cut temperature will be set as the setting temperature, and will be recorded. This parameter will be directly enabled when it is started up next time.

Note] Temperature setting range is 150-450 °C. The adjusting key will be invalid out of the range.

Change the temperature unit

Press the SET key and power on the equipment once more to switch between C and F.

User compensation the temperature

Under normal working status, long press SET key for 3S to enter user temperature calibration status (Short prompt displays CAL for about 1s). Under this circumstance, A/B/C storage temperature group number will disappear, and only display user temperature compensation value and power bar. User temperature compensation range: 50 °C ~ -50 °C (90 °F ~ -90 °F).

After adjusting the temperature compensation value, press the SET key to exit the user temperature compensation status. If this key is not pressed in 30 seconds, you will exit the user temperature compensation status. The new temperature compensation parameters will be recorded and will be enabled immediately.

For example: If the temperature of soldering iron is set and stabilized to around 350 °C, and the actual temperature measured with a thermometer is a 345 °C, the gap +5 °C shall be compensated. It means that the compensation value is calculated by subtracting the actual temperature value measured with a thermometer from the value displayed on soldering iron.

Auto sleep

When the soldering iron is powered on, the last setting temperature will be automatically enabled. If the soldering iron detects that the soldering iron is not used or no key is pressed within consecutive 10min., the soldering iron will shut down automatically. It will display OFF, and the background light will be off. If any vibration of the keys or soldering iron is detected, the operation will be automatically recovered.

Sleep On/Off

Press the "▼" key. Power on the equipment once more which can realize Sleep On/Off function.

Abnormal display

Failure symptom	Failure cause detection
E-1	Heating element failure or use model error
E-2	1. Heating element should be replaced if it is damaged. 2. In case of open circuit of sensor lead wire, check the lead wire of soldering iron.
E-6	The supply voltage is too low or too high.

USB transfer cable use

When using the two pin adapter, due to the different designs of the adapters of various manufacturers, a higher voltage may be generated at the USB output port. In order to ensure the safety of soldering, it is necessary to use the standard USB transfer cable alone to ground.

Product warranty card

This product is guaranteed for two years from the date of purchase. If any quality problem is found within the guarantee period, we will response for the maintenance free of charge on presentation of this card and the receipt. We will repair and return the repaired equipment to the customer within 2 working days of the receipt date.

Note: This warranty card must be attached when this product is returned to the factory for maintenance, otherwise free maintenance will not be accepted. Thank you for your cooperation!

Product Certification

Product Model: _____ Product No.: _____

Inspector: _____ Ex-factory date: _____

Salesperson: _____ Sold Date: _____

SHENZHEN ATTEN TECHNOLOGY CO., LTD.

Add: Floor 8, Building 2, Senyang High-tech Park, 7 West Road High-tech Park, Guangming New district, Shenzhen 518132, China

Tel: +86-755-2697 6387

ax: +86-755-8602 1337

Web: www.atten.com.cn(CN)

www.atten.com(EN)

Email: sales@atten.com.cn

Engineer's partner

All Copyright Reserved
MADE IN CHINA

CBN029957 (A)

联系售后

电话: (+86) 0755-8602 1266