

OTe 10/220...240/700 PC

OPTOTRONIC Phase-cut OTE | Compact constant current LED driver – Dimmable



Product family features

- Dimmable via leading edge/trailing edge
- Type of protection: IP20

Product family benefits

- Compact housing for mounting in very tight spaces
- Compatible with the most common leading-edge and trailing-edge phase dimmers

Areas of application

- Optional cable clamp E-style for independent mounting
- Suitable for indoor installations
- Suitable for indoor SELV installations



Technical data

Electrical data

Nominal input voltage	220...240 V
Mains frequency	50/60 Hz
Input voltage AC	198...264 V ¹⁾
Total harmonic distortion	< 20 %
Power factor λ	0.95/0.90 ²⁾
ECG efficiency	79 % ³⁾
Device power loss	2.8 W ⁴⁾
Inrush current	5 A ⁵⁾
Max. ECG no. on circuit breaker 10 A (B)	101
Max. ECG no. on circuit breaker 16 A (B)	160
Max. ECG no. on circuit breaker 25 A (B)	-
Surge capability (L/N-Ground)	1 kV
Surge capability (L-N)	1 kV
Nominal output voltage	7...14 V
U-OUT (working voltage)	25 V
Nominal output current	700 mA ⁶⁾
Output current tolerance	±10 %
Output ripple current (100 Hz)	35 % ⁷⁾
Output PSTLM	≤1
Output SVM	≤1.0
Nominal output power	10 W ⁸⁾
Galvanic isolation	SELV

¹⁾ Permitted voltage range

²⁾ Full load at 230 V/Minimum load at 230 V

³⁾ At full load and 230 V

⁴⁾ Maximum

⁵⁾ $t_{width} = 100 \mu s$ (measured at 50 % I_{peak})

⁶⁾ ±10%

⁷⁾ Typical

⁸⁾ Partial load 5...10 W

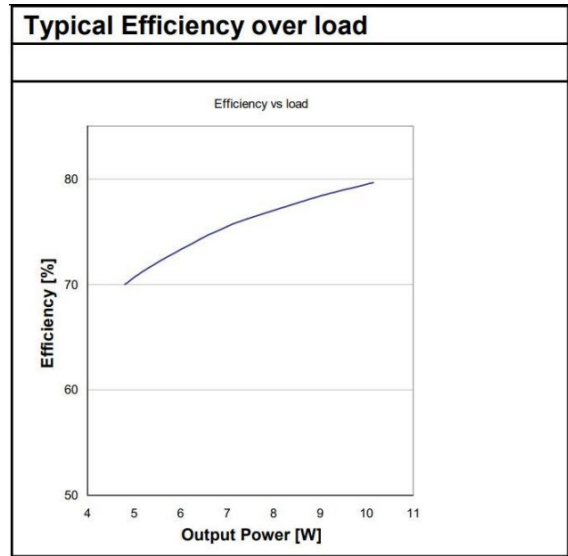
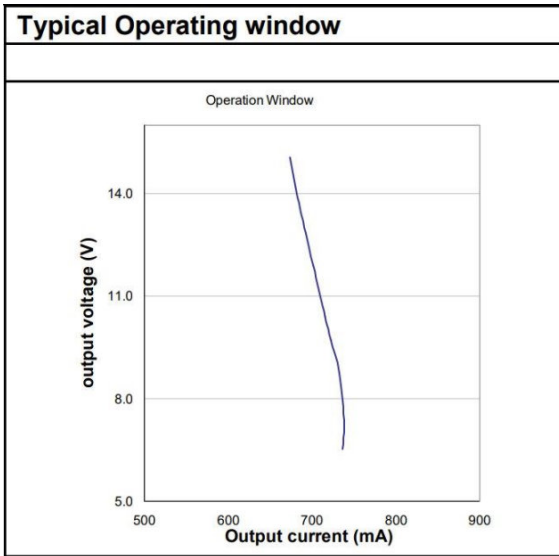

OTE 10220-240700 PC Operating Window

OTE 10220-240700 PC Typical Efficiency vs. Load (230 V 50 Hz)

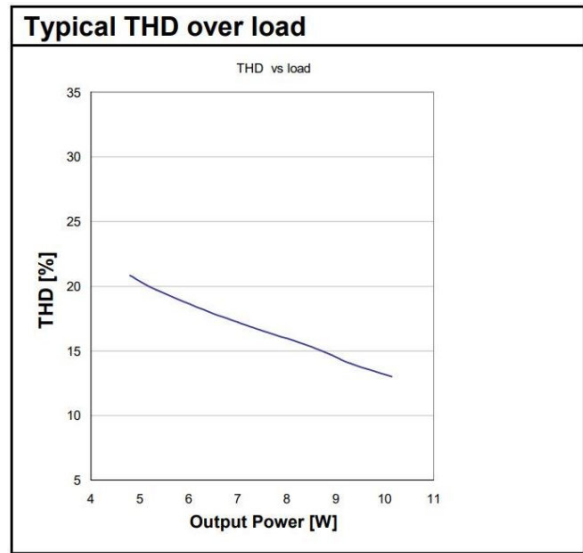
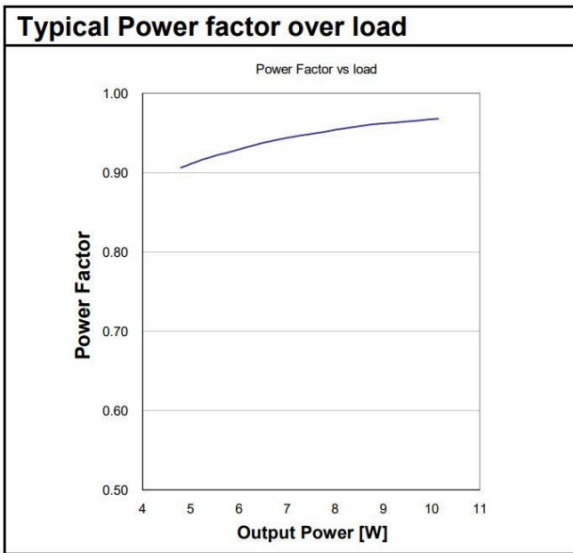

OTE 10220-240700 PC Typical Power Factor vs. Load

OTE 10220-240700 PC Typical THD Vs Load

Dimensions & weight

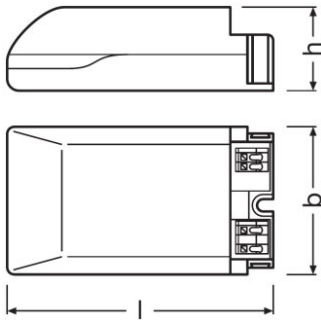

Mounting hole spacing, length	-
Mounting hole spacing, width	-
Product weight	81.00 g
Cable cross-section, input side	0.75...1.5 mm ² ¹⁾
Cable cross-section, output side	0.5...1.5 mm ² ¹⁾
Wire preparation length, input side	8.0...9.0 mm
Wire preparation length, output side	8.0...9.0 mm
Length	95.0 mm
Width	53.0 mm
Height	25.0 mm

¹⁾ Flexible / Solid leads

Colors & materials

Casing material	Plastic
-----------------	---------

Temperatures & operating conditions

Ambient temperature range	-20...+55 °C
Maximum temperature at tc test point	80 °C ¹⁾
Max.housing temperature in case of fault	110 °C
Temperature range at storage	-25...75 °C
Permitted rel. humidity during operation	5...85 % ²⁾

¹⁾ Maximum at the T_c-point

²⁾ Maximum 56 days/year at 85 %

Lifespan

ECG lifetime	50000 h ¹⁾
--------------	-----------------------

¹⁾ At $T_{case} = 70^{\circ}C$ at T_c point / 10% failure rate

Product datasheet

Capabilities

Dimmable	Yes
Dimming interface	Phase Cut ¹⁾
Dimming range	10...100 %
Dimming method	Amplitude Modulation
Overheating protection	Automatic reversible
Overload protection	Automatic reversible
Short-circuit protection	Automatic reversible
No-load proof	Yes
Max. cable length to lamp/LED module	2.0 m
Suitable for fixtures with prot. class	I / II
Type of connection, output side	Push terminal

¹⁾ Trailing edge / Leading edge







Certificates & standards

Approval marks – approval	CE / ENEC 10 / VDE / CB
Standards	Acc. to IEC 61347-1/Acc. to IEC 61347-2-13/Acc. to IEC 62384/Acc. to CISPR 15/Acc. to IEC 61000-3-2/Acc. to IEC 61000-3-3/Acc. to IEC 61547
Protection class	II
Type of protection	IP20





Logistical data

Commodity code	850440829000
-----------------------	--------------

Download Data

File	
	Product Datasheet 496532_OT Technical DS OTe 10 700 PC
	Certificates OT EMC 40038482 220421
	Certificates OT ENEC 40038447 210721
	Certificates 496535_CB report OTe 10 700 PC and OTe 13 350 PC
	Declarations of conformity OTe PC UK DoC 4281102 180221
	Declarations of conformity OTE PC CE 3365230 180221

Product datasheet

	Installation/Operation notice OT PC dimmer list (EN)
	Installation guide 501498_OTe 10220-240700 PC
	CAD data 3-dim 377012_OTe 10-13 PC -cable clamp
	CAD data 3-dim 377013_OTe 10-13 PC -housing
	CAD data 3-dim 377014_OTe 10-13 PC -housing with cable clamp

Logistical Data

Product code	Product description	Packaging unit (Pieces/Unit)	Dimensions (length x width x height)	Volume	Gross weight
4052899105300	OTe 10/220...240/700 PC	Shipping carton box 20	284 mm x 207 mm x 96 mm	5.64 dm ³	1890.00 g

The mentioned product code describes the smallest quantity unit which can be ordered. One shipping unit can contain one or more single products. When placing an order, for the quantity please enter single or multiples of a shipping unit.

Accessories Optional

Product description	Accessory name	Accessory code
OTe 10/220...240/700 PC	OT CABLE CLAMP E-STYLE	▶ 4052899167896

Disclaimer

Subject to change without notice. Errors and omission excepted. Always make sure to use the most recent release.