

"Schutzvermerk nach DIN ISO 16016 beachten" "Please pay attention to copyright note DIN ISO 16016"

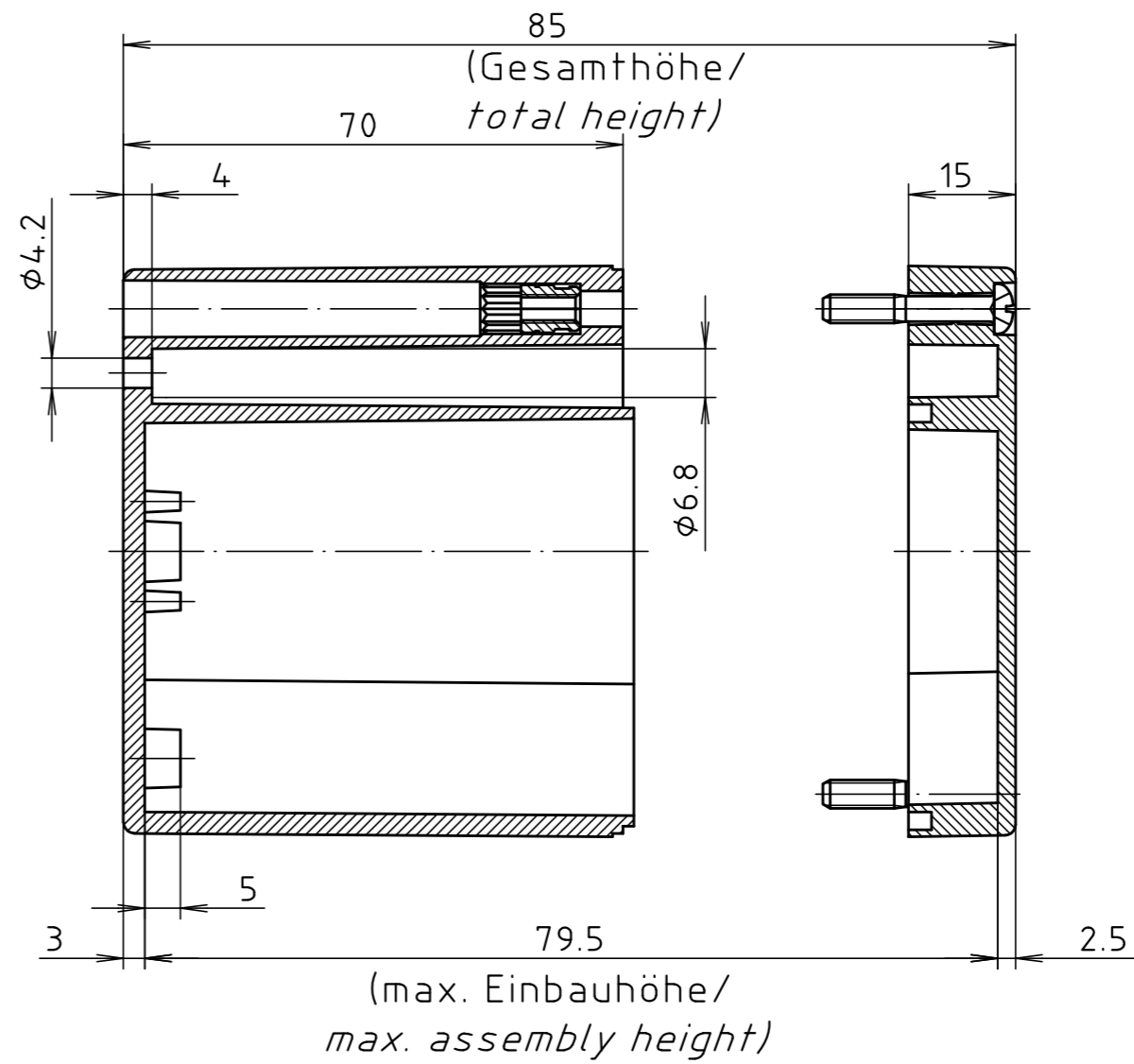
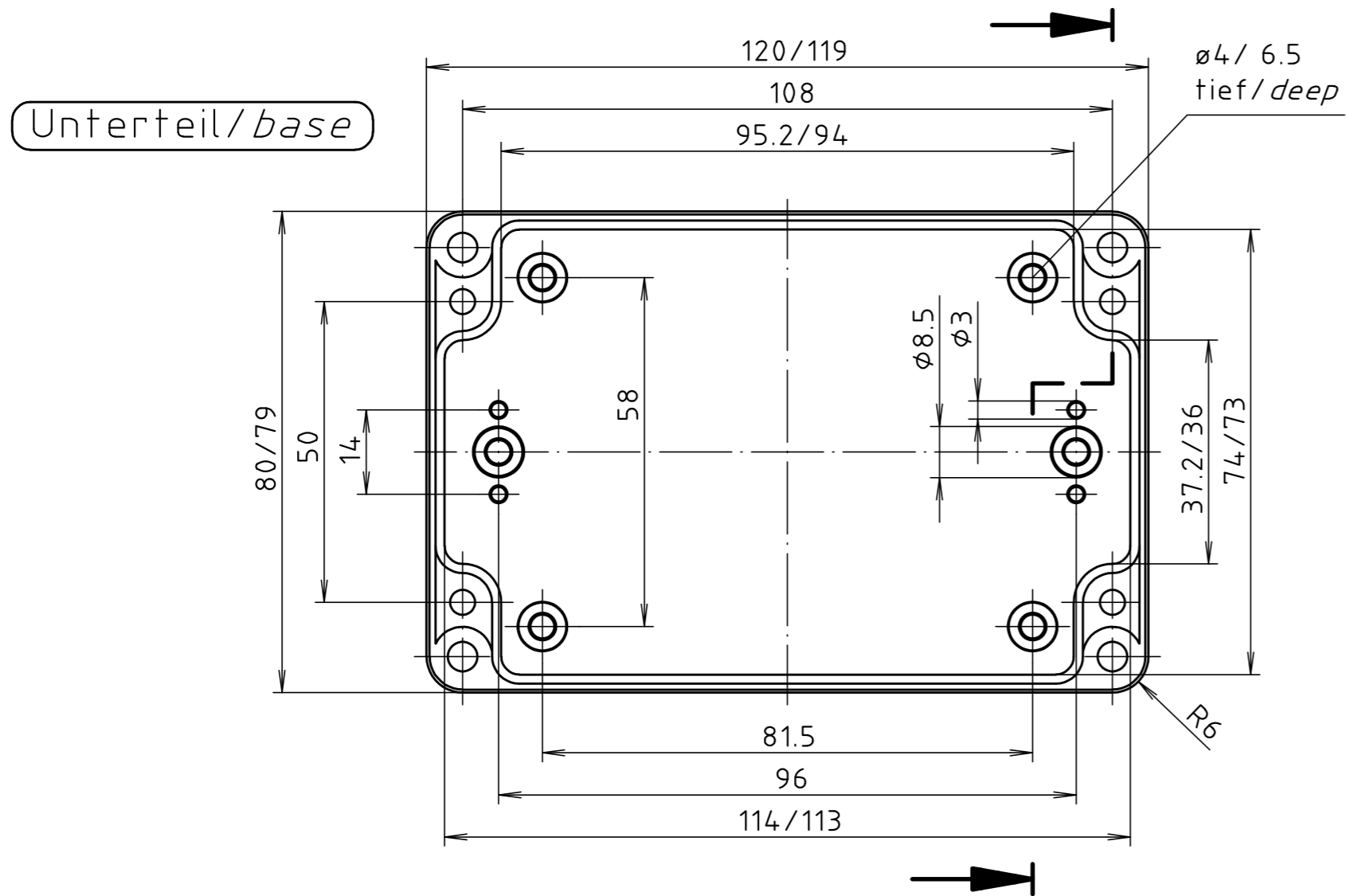
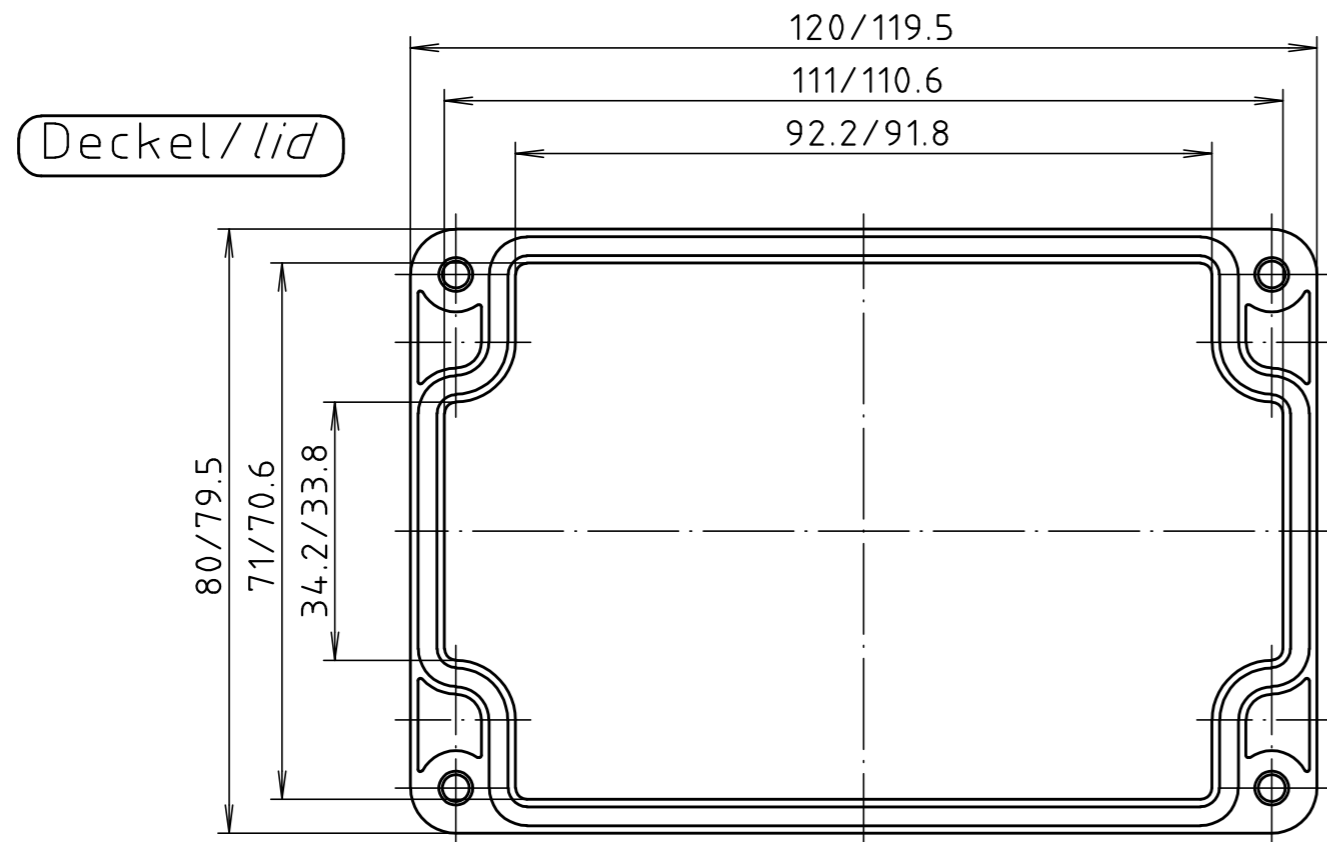

		Allgemein- toleranzen DIN .		Maßstab 1:1	Gewicht .
				Werkstoff ABS	Rohteil-Nr. .
		Datum	Name	Benennung	
		Bearb. 28.01.20	ES	ABS 320600 5U Gehäuse/ Enclosure	
		Gepr. .		Zchnng.-Nr.	Blatt
		Norm .		5U320600	Bl.
Zust.	Anderung	Datum	Name	Urspr.:	Ers.für: . Ers.durch: .