

"Schutzvermerk nach DIN ISO 16016 beachten" "Please pay attention to copyright note DIN ISO 16016"

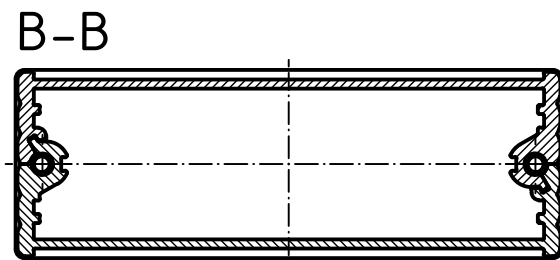

Maßstab/ Scale: 1:1

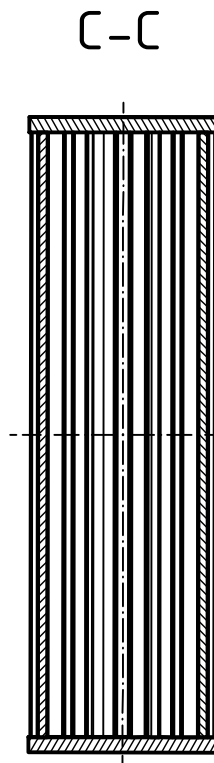
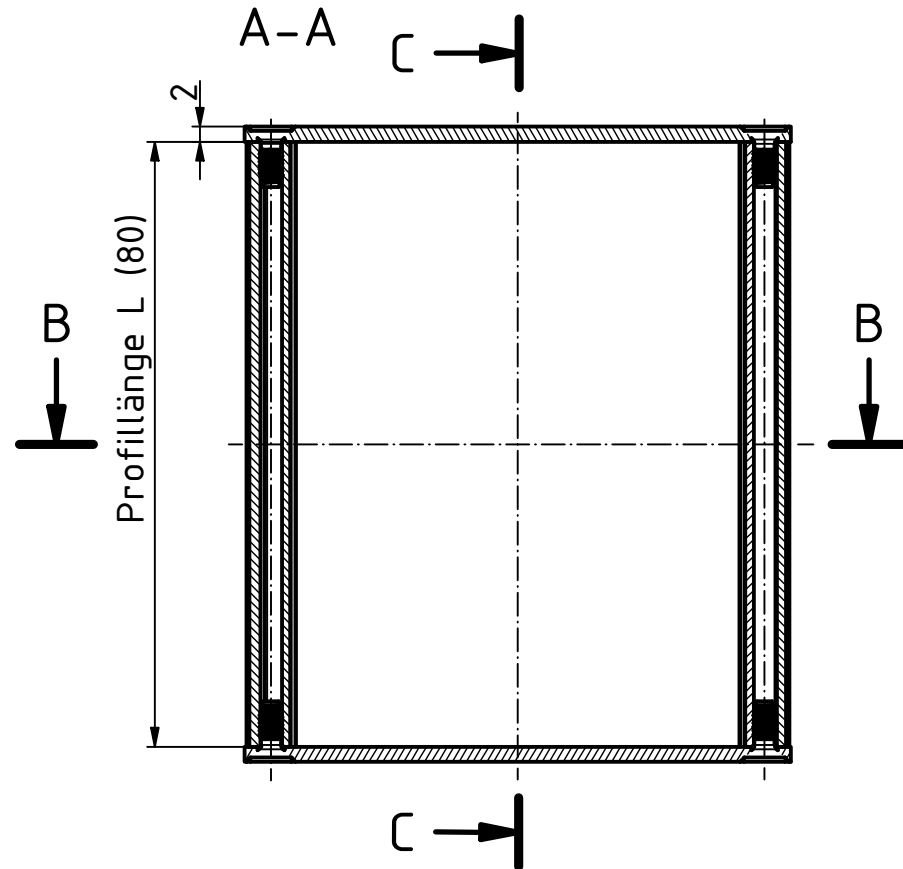
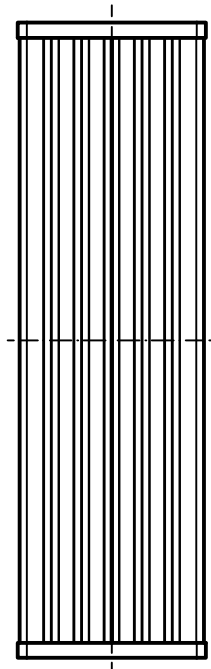
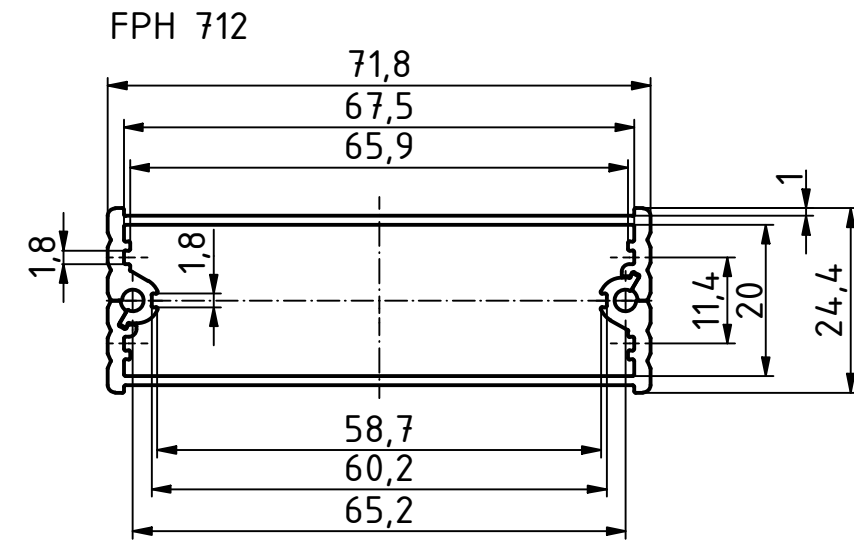
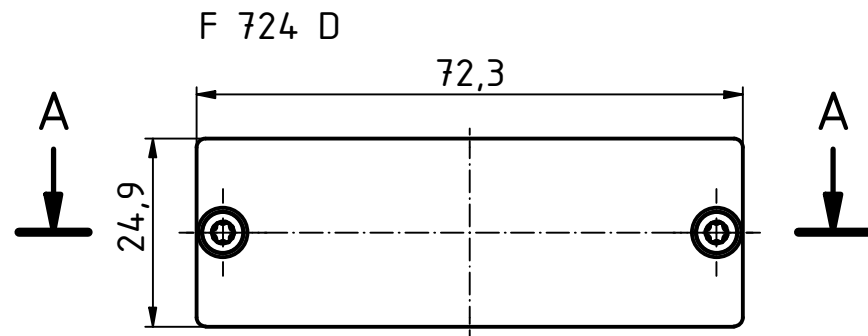
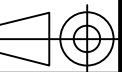

Zeichnungs-Nr. / Drawing-No.:

Artikel / Article:
 FiloTec m. Deckel
 FPH 712 + F 720 D
 Katalogzeichnung

Ä.Nr / Alt.No:

Datum / Date:



DISK: FPH 712-80 + F 724 D.idw
 Datum/Date: 19.09.2019 AH