

CUTE-3-W

~40° wide beam with 1.5 mm high location pins

SPECIFICATION:

Dimensions	Ø 35.0 mm
Height	15 mm
Fastening	glue, pin
ROHS compliant	yes ⓘ



MATERIALS:

Component	Type	Material	Colour	Finish	Length
CUTE-3-W	Multi-lens	PMMA	clear		35.0

ORDERING INFORMATION:

Component	Qty in box	MOQ	MPQ	Box weight (kg)
C10756_CUTE-3-W » Box size: 480 x 280 x 300 mm	630	90	45	7.0

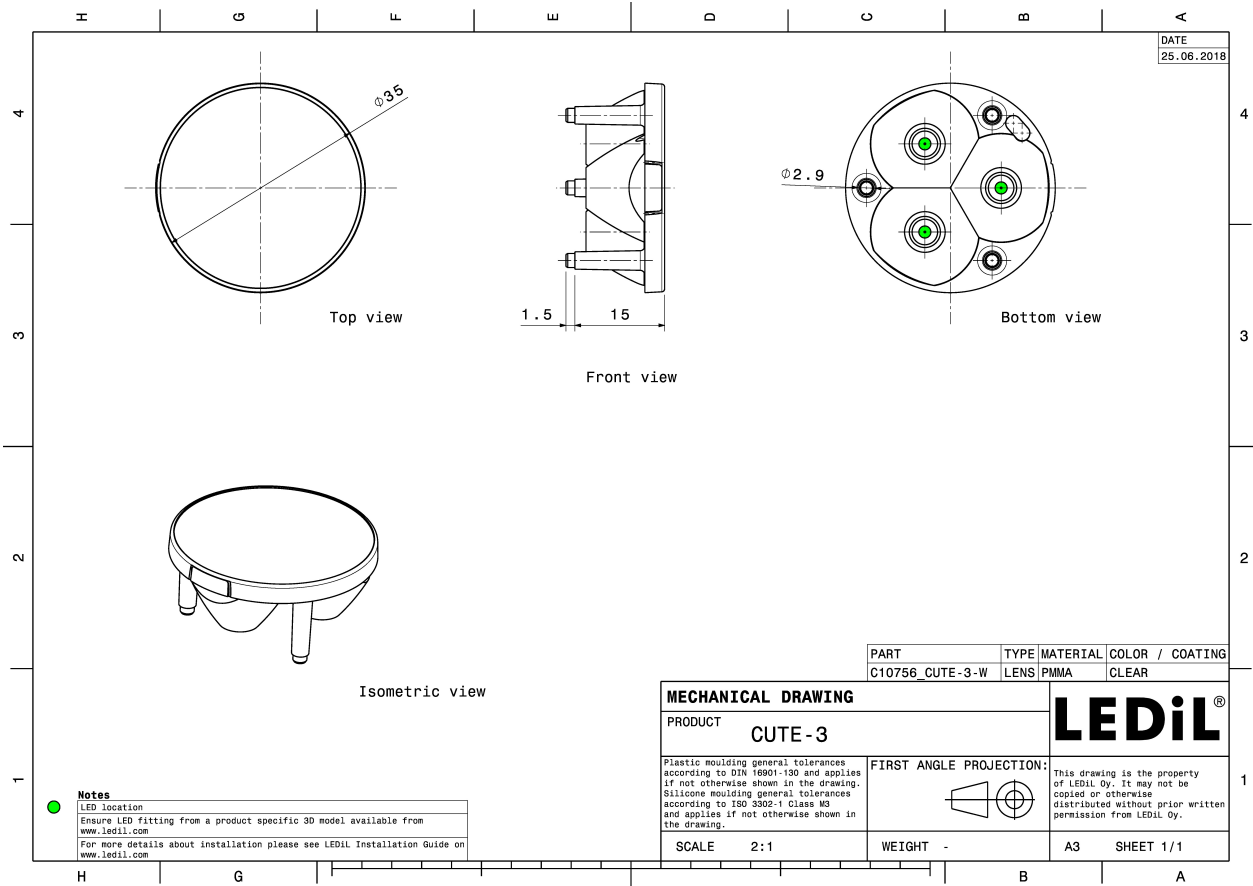

See also our general installation guide: www.ledil.com/installation_guide

OPTICAL RESULTS (MEASURED):



LED XP-E
FWHM / FWTM 40.0° / 70.0°
Efficiency 90 %
Peak intensity 1.5 cd/lm
LEDs/each optic 1
Light colour/type White
Required components:

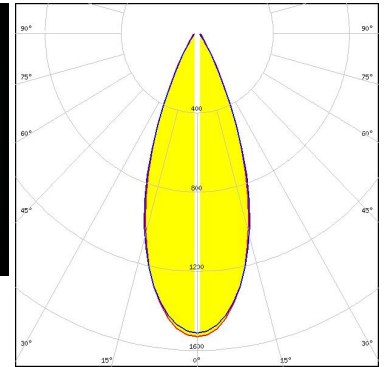
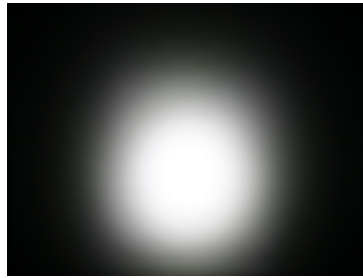

Light distribution files



LED XP-G
FWHM / FWTM 40.0° / 68.0°
Efficiency 90 %
Peak intensity 1.4 cd/lm
LEDs/each optic 1
Light colour/type White
Required components:

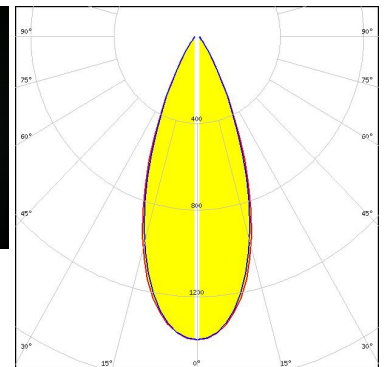
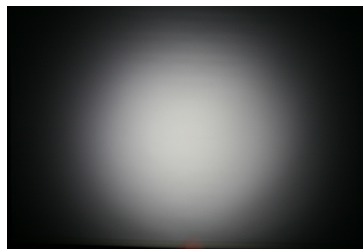

Light distribution files



LED XP-G2
FWHM / FWTM 40.0° / 68.0°
Efficiency 87 %
Peak intensity 1.8 cd/lm
LEDs/each optic 1
Light colour/type White
Required components:

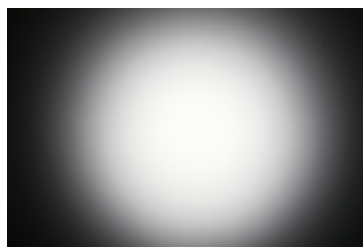

Light distribution files

OPTICAL RESULTS (MEASURED):



LED XP-L HD
FWHM / FWTM 46.0° / 76.0°
Efficiency 84 %
Peak intensity 1.4 cd/lm
LEDs/each optic 1
Light colour/type White
Required components:

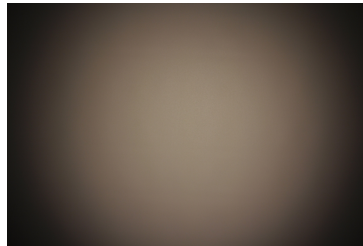

[Light distribution files](#)



LED XT-E
FWHM / FWTM 39.0° / 68.0°
Efficiency %
Peak intensity 1.7 cd/lm
LEDs/each optic 1
Light colour/type White
Required components:

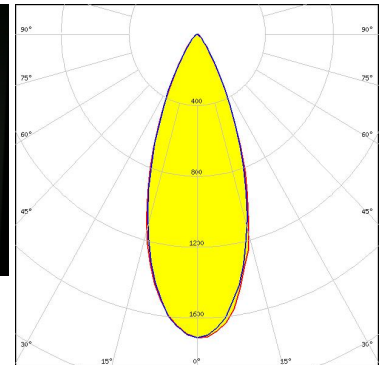
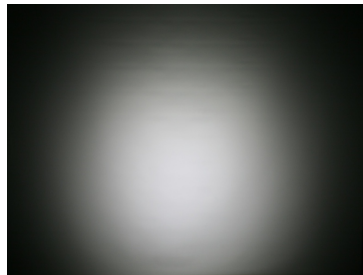

[Light distribution files](#)



LED LUXEON A
FWHM / FWTM 41.0°
Efficiency 77 %
LEDs/each optic 1
Light colour/type White
Required components:

[Light distribution files](#)

OPTICAL RESULTS (MEASURED):



LED LUXEON Rebel
FWHM / FWTM 38.0°
Efficiency 77 %
LEDs/each optic 1
Light colour/type White
Required components:

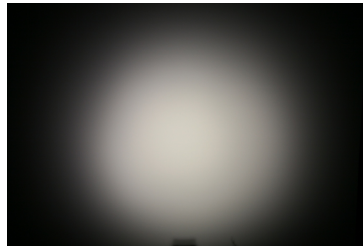

Light distribution files



LED LUXEON Rebel ES
FWHM / FWTM 41.0°
Efficiency 77 %
LEDs/each optic 1
Light colour/type White
Required components:

Light distribution files



LED LUXEON T
FWHM / FWTM 42.0° / 70.0°
Efficiency 86 %
Peak intensity 1.6 cd/lm
LEDs/each optic 1
Light colour/type White
Required components:

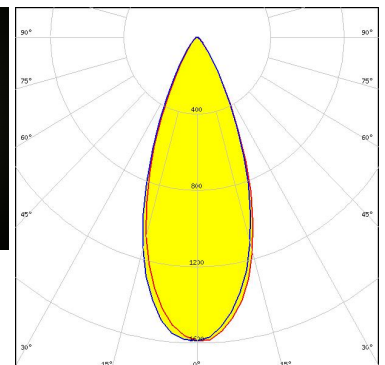
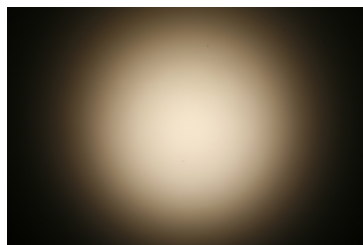

Light distribution files

OPTICAL RESULTS (MEASURED):



LED LUXEON TX
FWHM / FWTM 40.0° / 67.0°
Efficiency 85 %
Peak intensity 1.7 cd/lm
LEDs/each optic 1
Light colour/type White
Required components:

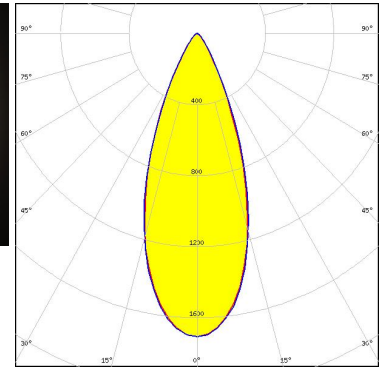

Light distribution files



LED NCSxx19A
FWHM / FWTM 39.0°
Efficiency 84 %
LEDs/each optic 1
Light colour/type White
Required components:

Light distribution files



LED NCSxx19B
FWHM / FWTM 38.0° / 67.0°
Efficiency 85 %
Peak intensity 1.8 cd/lm
LEDs/each optic 1
Light colour/type White
Required components:

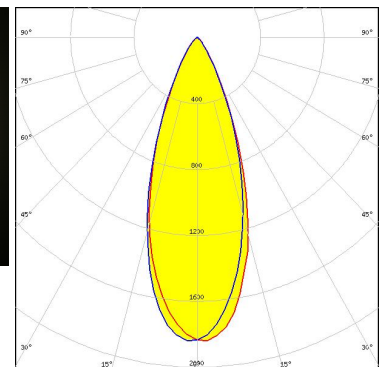
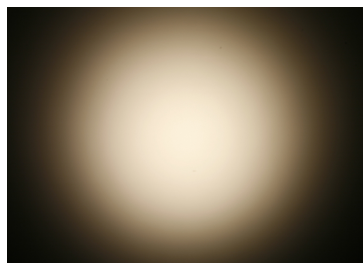

Light distribution files

OPTICAL RESULTS (MEASURED):



LED NVSxx19A
FWHM / FWTM 38.0° / 68.0°
Efficiency 90 %
Peak intensity 1.6 cd/lm
LEDs/each optic 1
Light colour/type White
Required components:

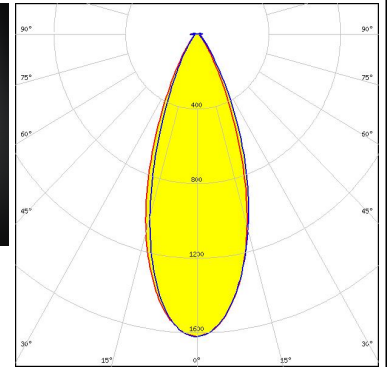

Light distribution files



LED OSLOM Square EC
FWHM / FWTM 36.0° / 66.0°
Efficiency 78 %
Peak intensity 1.9 cd/lm
LEDs/each optic 1
Light colour/type White
Required components:

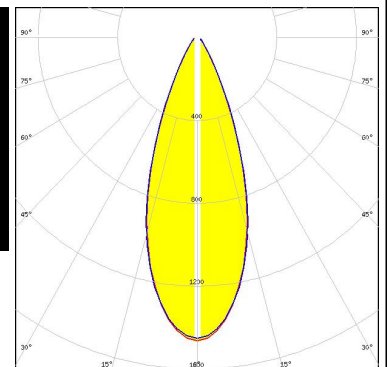
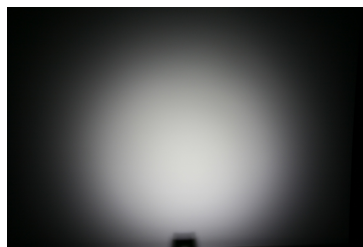

Light distribution files



LED OSLOM SSL 80
FWHM / FWTM 40.0°
Efficiency 83 %
LEDs/each optic 1
Light colour/type White
Required components:

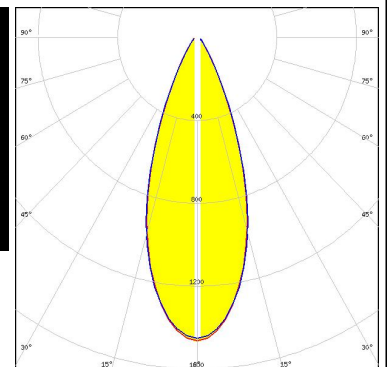
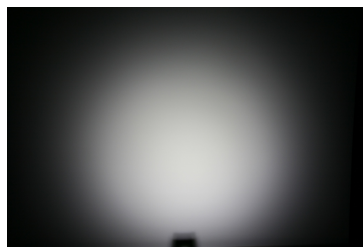

Light distribution files

OPTICAL RESULTS (MEASURED):

SEUL
SEOUL SEMICONDUCTOR

LED	Z5
FWHM / FWTM	40.0°
Efficiency	%
LEDs/each optic	1
Light colour/type	White
Required components:	

Light distribution files

SEUL
SEOUL SEMICONDUCTOR

LED	Z5M1/Z5M2
FWHM / FWTM	38.0° / 67.0°
Efficiency	84 %
Peak intensity	1.7 cd/lm
LEDs/each optic	1
Light colour/type	White
Required components:	

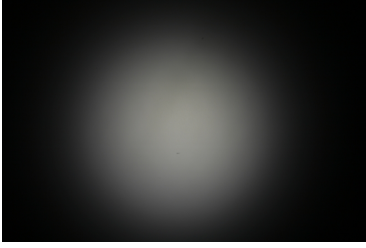
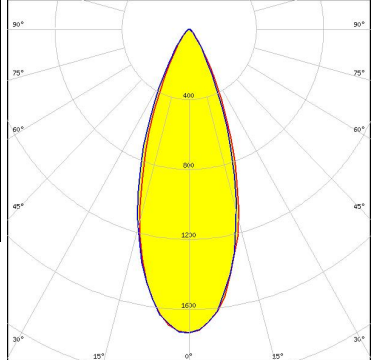
Light distribution files

TOSHIBA
Leading Innovation >>>

LED	TL1L3
FWHM / FWTM	42.0° / 75.0°
Efficiency	90 %
Peak intensity	1.3 cd/lm
LEDs/each optic	1
Light colour/type	White
Required components:	

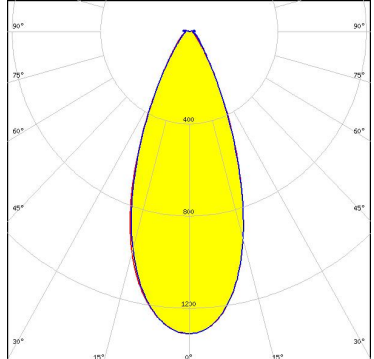

Light distribution files

OPTICAL RESULTS (SIMULATED):



LED XB-D
FWHM / FWTM 30.0° / 50.0°
Efficiency 84 %
Peak intensity 2.8 cd/lm
LEDs/each optic 1
Light colour/type White
Required components:

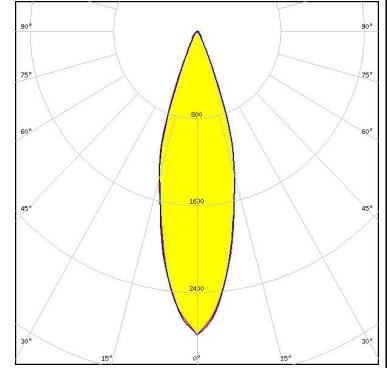

LED XHP35 HD
FWHM / FWTM 45.0° / 65.0°
Efficiency 90 %
Peak intensity 1.6 cd/lm
LEDs/each optic 1
Light colour/type White
Required components:

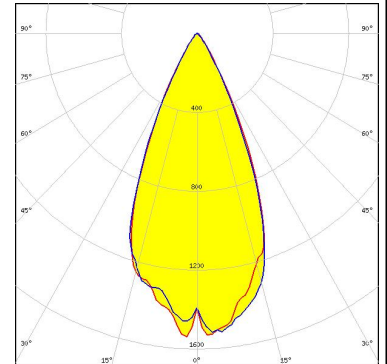

Light distribution files



LED XHP35 HI
FWHM / FWTM 41.0° / 56.0°
Efficiency 93 %
Peak intensity 2.3 cd/lm
LEDs/each optic 1
Light colour/type White
Required components:

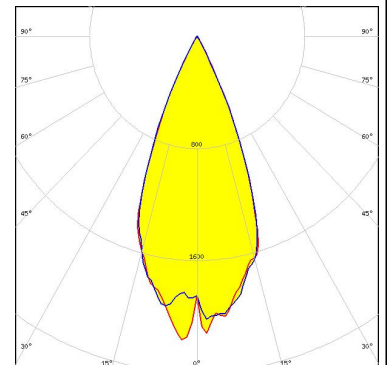

Light distribution files

OPTICAL RESULTS (SIMULATED):



LED XP-G3
FWHM / FWTM 44.0° / 67.0°
Efficiency 94 %
Peak intensity 1.7 cd/lm
LEDs/each optic 1
Light colour/type White
Required components:

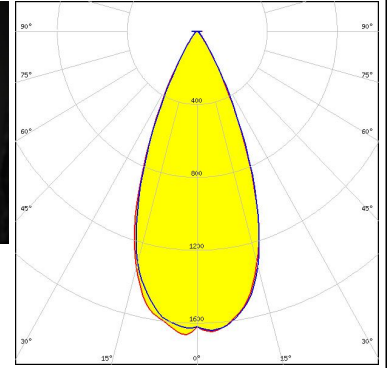
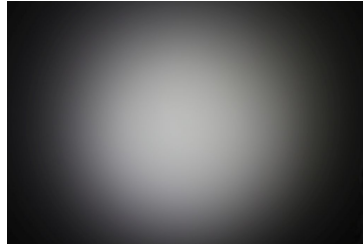

Light distribution files



LED XT-E HVW
FWHM / FWTM 40.0°
Efficiency %
LEDs/each optic 1
Light colour/type White
Required components:

Light distribution files



LED LUXEON H50-2
FWHM / FWTM 41.0° / 59.0°
Efficiency 90 %
Peak intensity 2.1 cd/lm
LEDs/each optic 1
Light colour/type White
Required components:

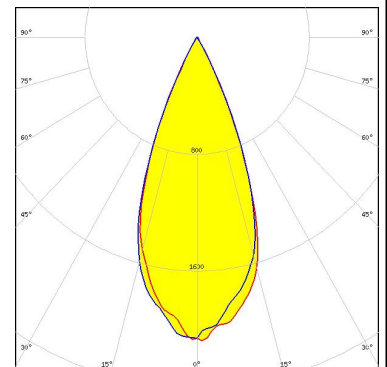

Light distribution files

OPTICAL RESULTS (SIMULATED):

NICHIA

LED	NVSxx19B/NVSxx19C
FWHM / FWTM	41.0° / 61.0°
Efficiency	92 %
Peak intensity	1.9 cd/lm
LEDs/each optic	1
Light colour/type	White
Required components:	

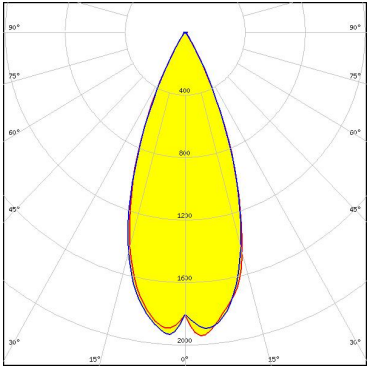

Light distribution files

OSRAM
Opto Semiconductors

LED	OSLON SSL 150
FWHM / FWTM	42.0° / 54.0°
Efficiency	96 %
Peak intensity	2.3 cd/lm
LEDs/each optic	1
Light colour/type	White
Required components:	



Light distribution files

SAMSUNG

LED	LH351B
FWHM / FWTM	44.0° / 66.0°
Efficiency	95 %
Peak intensity	1.7 cd/lm
LEDs/each optic	1
Light colour/type	White
Required components:	

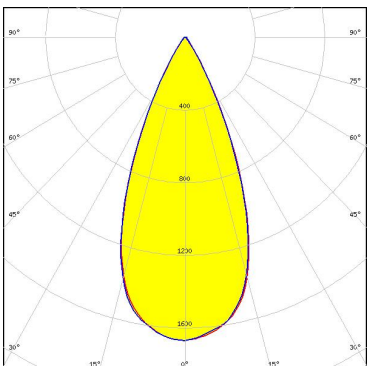

Light distribution files

OPTICAL RESULTS (SIMULATED):

SAMSUNG

LED	LH351C
FWHM / FWTM	46.0° / 66.0°
Efficiency	96 %
Peak intensity	1.7 cd/lm
LEDs/each optic	1
Light colour/type	White
Required components:	

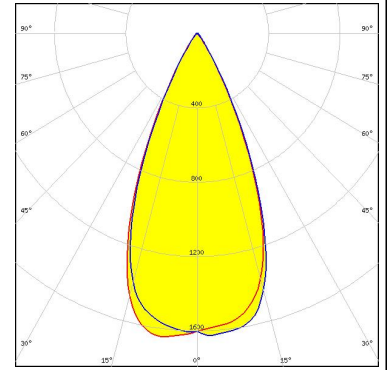

GENERAL INFORMATION:

NOTE: The typical beam angle will be changed by different color, chip size and chip position tolerance. The typical total beam angle is the full angle measured where the luminous intensity is half of the peak value.

MATERIALS:

As part of our continuous research and improvement processes, and to ensure the best possible quality and availability of our products, LEDiL reserves the right to change material grades without notice.

PRODUCT DATA USER AGREEMENT AND DISCLAIMER:

The measured data in the provided downloadable LEDiL Product Datasheets and Mechanical 2D-Drawings is rounded and provided as reference for planning. LEDiL Oy's optical specifications have been verified by conducting performance testing of the products in accordance with the company's quality system. The reported data are averaged results of multiple measurements with typical variation. LEDiL Oy reserves the right to without prior notification make changes and improvements to its products.

LEDiL Oy assumes neither warranty, nor guarantee nor any other liability of any kind for the contents and correctness of the provided data. The provided data has been generated with highest diligence but the provided data may in reality not represent the complete possible variation range of all intrinsic parameters. Therefore, in certain cases a deviation from the provided data could occur.

LEDiL Oy reserves the right to undertake technical changes of its products without further notification which could lead to changes in the provided data. LEDiL Oy assumes no liability of any kind for the possible deviation from any provided data or any other damage resulting from the usage of the provided data.

The user agrees to this disclaimer and user agreement with the download or usage of the provided files.

LEDiL Oy

Joensuunkatu 13
FI-24240 SALO
Finland

LEDiL Inc.

228 West Page Street
Suite D
Sycamore IL 60178
USA

Ledil Optics Technology (Shenzhen) Co., Ltd.

405 , Block B
Casic Motor Building
Shenzhen 518057
P.R.CHINA

Local sales and technical support

[www.ledil.com/
where_to_buy](http://www.ledil.com/where_to_buy)

Shipping locations

Poznan, Poland
Hong Kong, China

Distribution Partners

[www.ledil.com/
where_to_buy](http://www.ledil.com/where_to_buy)