

MOLLY-S-B

~25° spot beam compatible with 3rd party connectors from BJB, Stucchi and Tridonic

SPECIFICATION:

Dimensions	Ø 69.8 mm
Height	24.8 mm
ROHS compliant	yes ⓘ



MATERIALS:

Component	Type	Material	Colour	Finish	Length
MOLLY-S-B	Single lens	PMMA	clear		69.8

ORDERING INFORMATION:

Component	Qty in box	MOQ	MPQ	Box weight (kg)
C16263_MOLLY-S-B » Box size: 480 x 280 x 300 mm	180	36	18	9.6

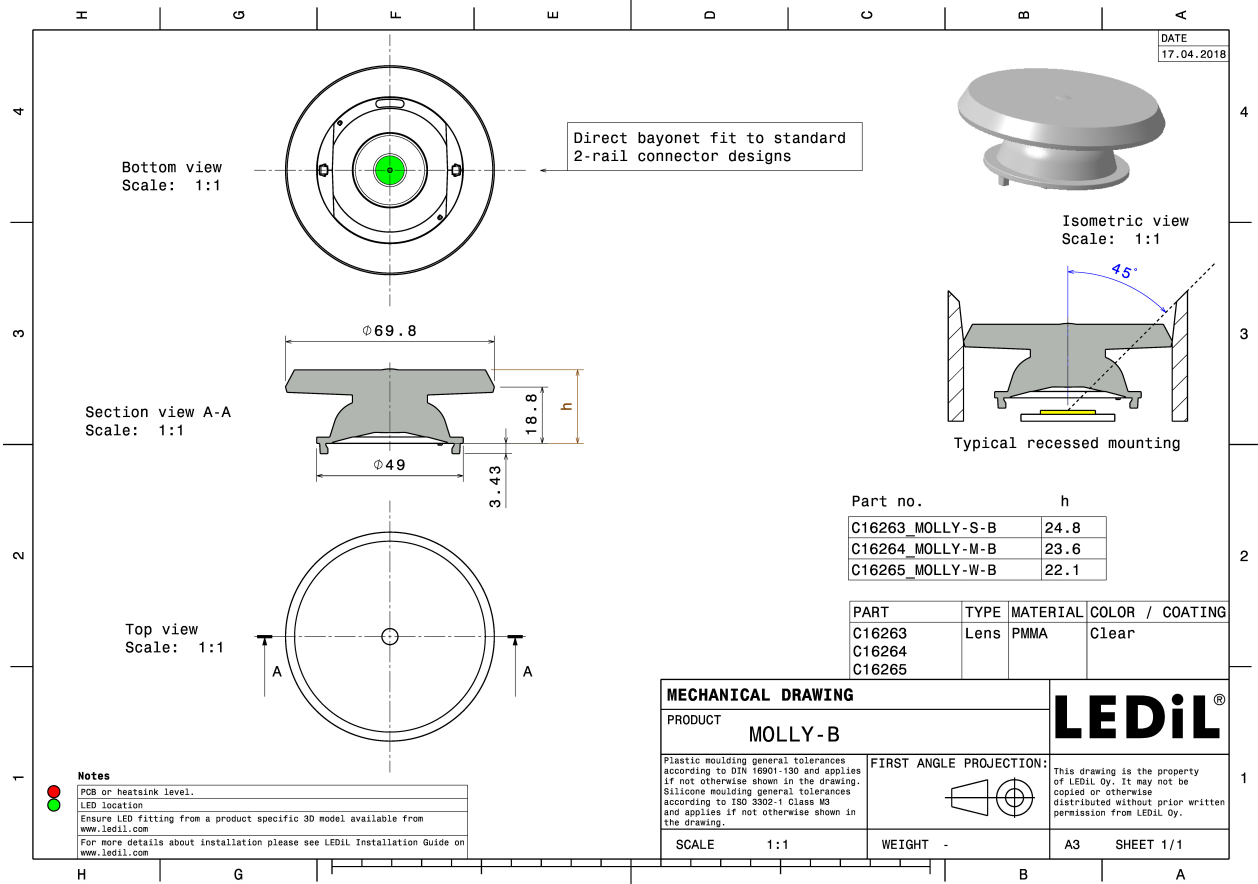

See also our general installation guide: www.ledil.com/installation_guide

OPTICAL RESULTS (MEASURED):

CITIZEN

LED CLL03x/CLU03x
FWHM / FWTM 24.0° / 42.0°
Efficiency 91 %
Peak intensity 4 cd/lm
LEDs/each optic 1
Light colour/type White
Required components:
BJB: 47.319.2021

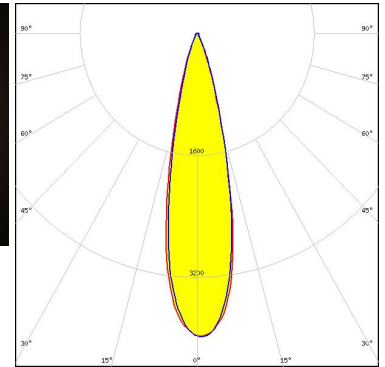

Light distribution files

LUMILEDS

LED LUXEON CoB 1208
FWHM / FWTM 26.0° / 44.0°
Efficiency 92 %
Peak intensity 3.7 cd/lm
LEDs/each optic 1
Light colour/type White
Required components:
BJB: 47.319.2011

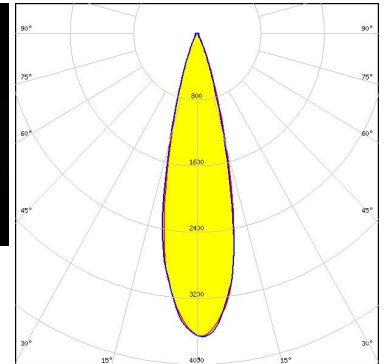
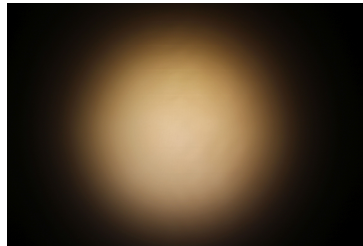

Light distribution files

TRIDONIC

LED SLE G7 LES15
FWHM / FWTM 26.0° / 44.0°
Efficiency 92 %
Peak intensity 3.6 cd/lm
LEDs/each optic 1
Light colour/type White
Required components:
BJB: 47.319.2021

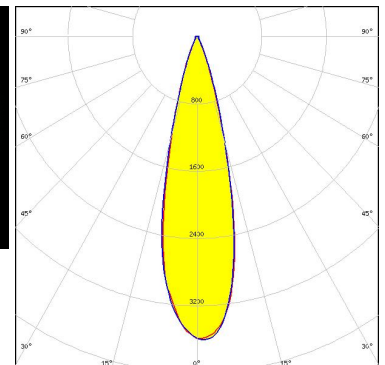
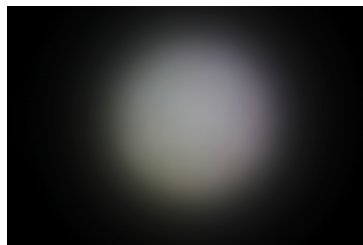

Light distribution files

OPTICAL RESULTS (MEASURED):

TRIDONIC

LED SLE G7 LES17 H
 FWHM / FWTM 27.0° / 49.0°
 Efficiency 88 %
 Peak intensity 2.8 cd/lm
 LEDs/each optic 1
 Light colour/type White
 Required components:

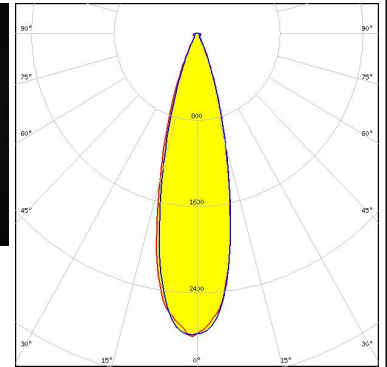

Light distribution files

TRIDONIC

LED SLE G7 LES21 H
 FWHM / FWTM 32.0° / 59.0°
 Efficiency 86 %
 Peak intensity 1.9 cd/lm
 LEDs/each optic 1
 Light colour/type White
 Required components:

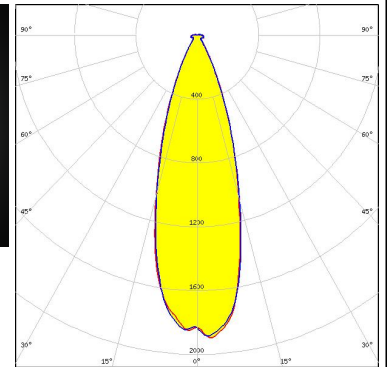
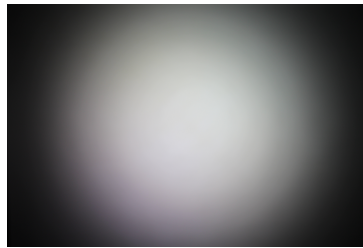

Light distribution files

XICATO

LED XOB 14.5 mm
 FWHM / FWTM 25.0° / 43.0°
 Efficiency 92 %
 Peak intensity 3.9 cd/lm
 LEDs/each optic 1
 Light colour/type White
 Required components:
 BJB: 47.319.2021

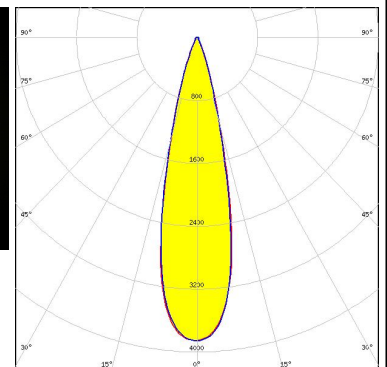
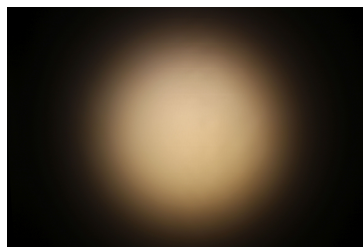

Light distribution files

OPTICAL RESULTS (SIMULATED):

CITIZEN

LED	CLL03x/CLU03x
FWHM / FWTM	23.0°
Efficiency	89 %
Peak intensity	3.9 cd/lm
LEDs/each optic	1
Light colour/type	White
Required components:	

BJB: 47.319.2021

GENERAL INFORMATION:

NOTE: The typical beam angle will be changed by different color, chip size and chip position tolerance. The typical total beam angle is the full angle measured where the luminous intensity is half of the peak value.

Due to use of high power COB's with this product, special attention to proper thermal design is highly recommended. LEDiL has no liability for direct, indirect or consecutive damages arising from the LEDiL products being used outside of the recommended temperature range.

MATERIALS:

As part of our continuous research and improvement processes, and to ensure the best possible quality and availability of our products, LEDiL reserves the right to change material grades without notice.

PRODUCT DATA USER AGREEMENT AND DISCLAIMER:

The measured data in the provided downloadable LEDiL Product Datasheets and Mechanical 2D-Drawings is rounded and provided as reference for planning. LEDiL Oy's optical specifications have been verified by conducting performance testing of the products in accordance with the company's quality system. The reported data are averaged results of multiple measurements with typical variation. LEDiL Oy reserves the right to without prior notification make changes and improvements to its products.

LEDiL Oy assumes neither warranty, nor guarantee nor any other liability of any kind for the contents and correctness of the provided data. The provided data has been generated with highest diligence but the provided data may in reality not represent the complete possible variation range of all intrinsic parameters. Therefore, in certain cases a deviation from the provided data could occur.

LEDiL Oy reserves the right to undertake technical changes of its products without further notification which could lead to changes in the provided data. LEDiL Oy assumes no liability of any kind for the possible deviation from any provided data or any other damage resulting from the usage of the provided data.

The user agrees to this disclaimer and user agreement with the download or usage of the provided files.

LEDiL Oy

Joensuunkatu 13
FI-24240 SALO
Finland

LEDiL Inc.

228 West Page Street
Suite D
Sycamore IL 60178
USA

Ledil Optics Technology (Shenzhen) Co., Ltd.

405 , Block B
Casic Motor Building
Shenzhen 518057
P.R.CHINA

Local sales and technical support

[www.ledil.com/
where_to_buy](http://www.ledil.com/where_to_buy)

Shipping locations

Poznan, Poland
Hong Kong, China

Distribution Partners

[www.ledil.com/
where_to_buy](http://www.ledil.com/where_to_buy)