

## YASMEEN-50-W-C

~36° wide beam. Assembly with holder C compatible with HEKLA sockets and connectors. Black version.

### TECHNICAL SPECIFICATIONS:

Dimensions	Ø 49.9 mm
Height	28.1 mm
ROHS compliant	yes ⓘ



### MATERIAL SPECIFICATIONS:

Component	Type	Material	Colour	Finish
YASMEEN-50-W	Single lens	PMMA	clear	
YASMEEN-50-HLD-C	Holder	PC	black	





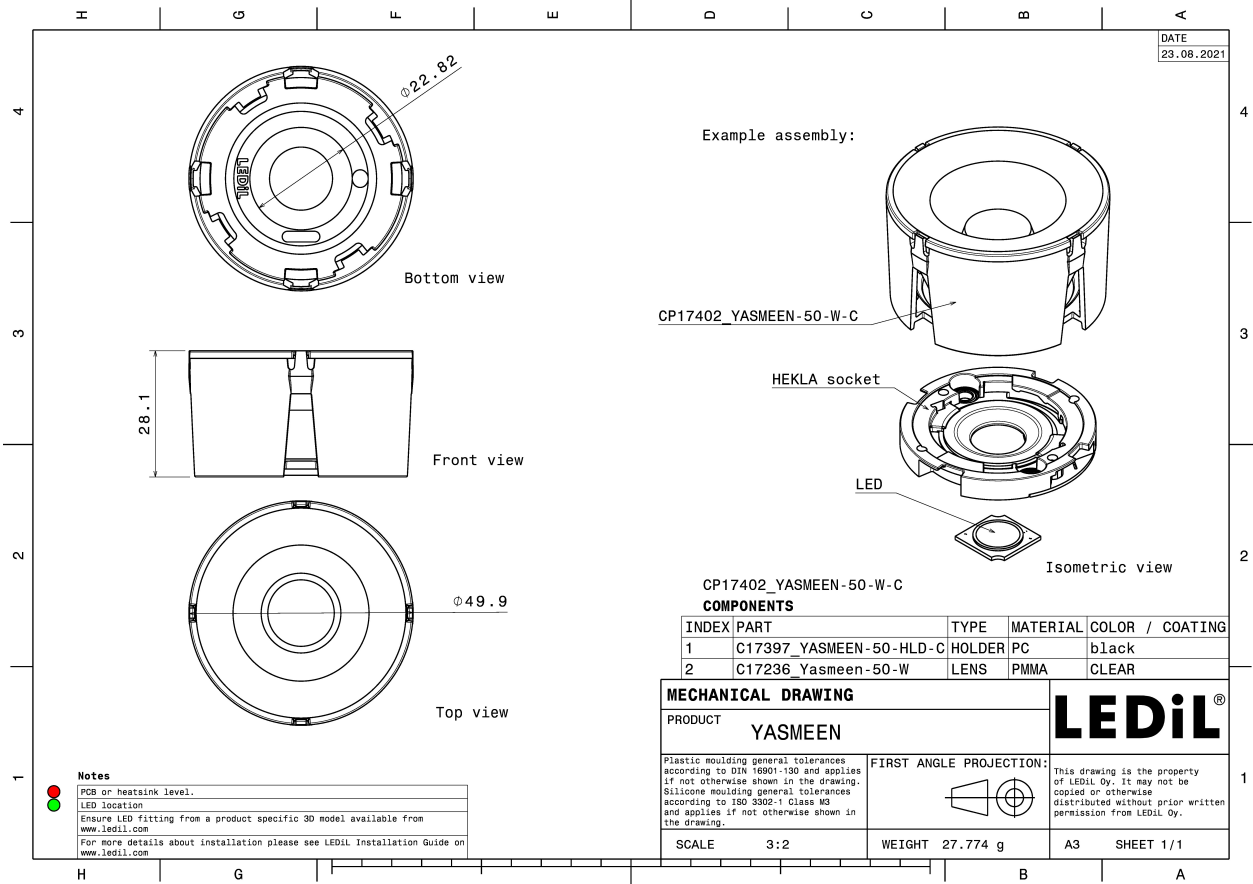

### ORDERING INFORMATION:

Component	Type	Qty in box	MOQ	MPQ	Box weight (kg)
CP17402_YASMEEN-50-W-C » Box size: 476 x 273 x 305 mm	Single lens	252	112	28	9.2

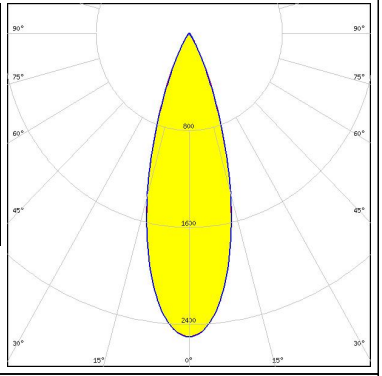

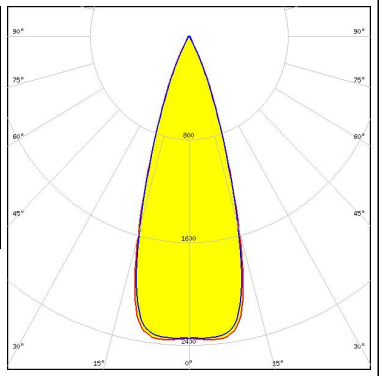

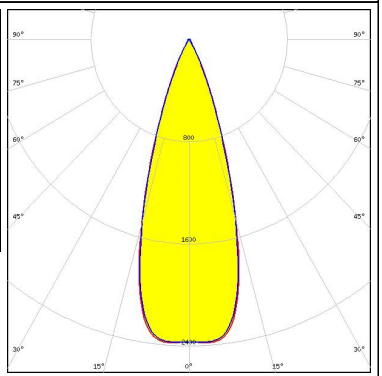

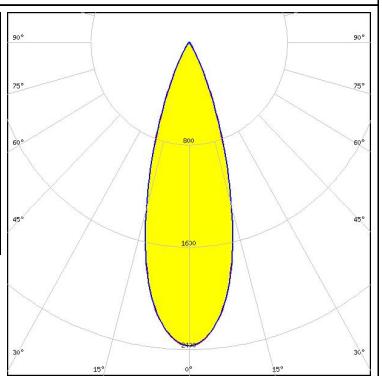

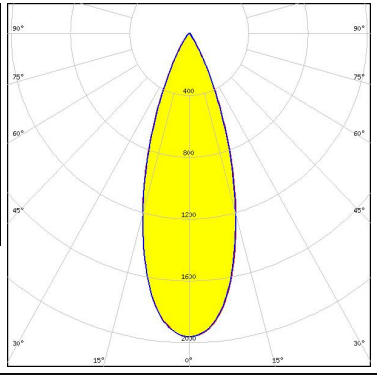

See also our general installation guide: [www.ledil.com/installation\\_guide](http://www.ledil.com/installation_guide)

#### PHOTOMETRIC DATA (MEASURED):

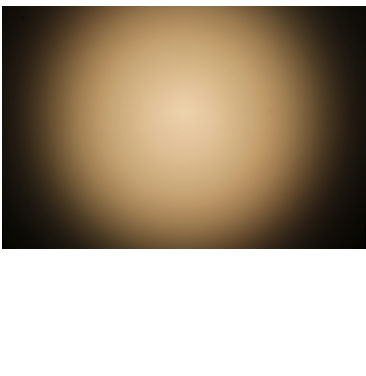
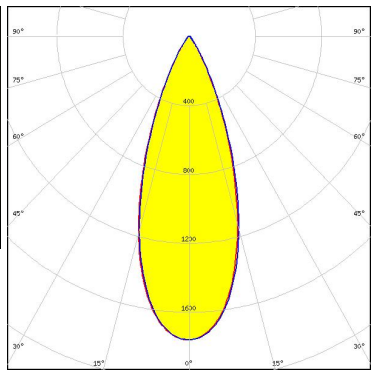
<p>bridgelux.</p> <p>LED V11 HD</p> <p>FWHM / FWTM 32.0° / 55.0°</p> <p>Efficiency 85 %</p> <p>Peak intensity 2.5 cd/m</p> <p>LEDs/each optic 1</p> <p>Light colour White</p> <p>Required components: Bender Wirth: 633d Hekla</p>		
<p>bridgelux.</p> <p>LED V4 HD</p> <p>FWHM / FWTM 34.0° / 52.0°</p> <p>Efficiency 83 %</p> <p>Peak intensity 2.4 cd/m</p> <p>LEDs/each optic 1</p> <p>Light colour White</p> <p>Required components: F15253_HEKLA-SOCKET-A</p>		
<p>bridgelux.</p> <p>LED V6 HD</p> <p>FWHM / FWTM 33.0° / 52.0°</p> <p>Efficiency 83 %</p> <p>Peak intensity 2.4 cd/m</p> <p>LEDs/each optic 1</p> <p>Light colour White</p> <p>Required components: F15255_HEKLA-SOCKET-C</p>		
<p>bridgelux.</p> <p>LED VERO10</p> <p>FWHM / FWTM 32.5° / 55.0°</p> <p>Efficiency 81 %</p> <p>Peak intensity 2.4 cd/m</p> <p>LEDs/each optic 1</p> <p>Light colour White</p> <p>Required components: F15616_HEKLA-SOCKET-F</p>		

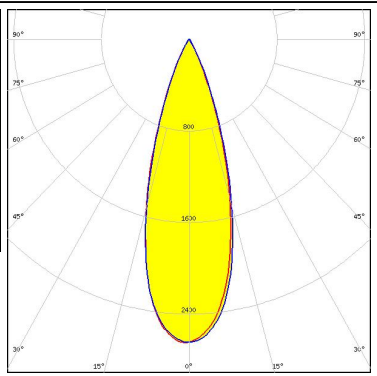
#### PHOTOMETRIC DATA (MEASURED):

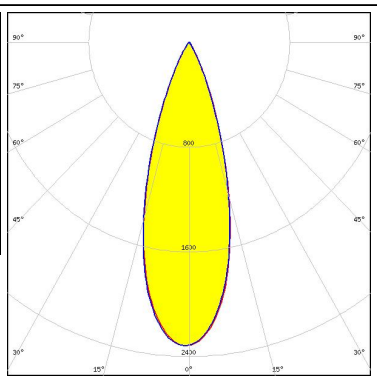
<p></p> <p>LED Vesta DTW 13mm (21W)            FWHM / FWTM 35.0° / 60.0°            Efficiency 81 %            Peak intensity 2 cd/m            LEDs/each optic 1            Light colour Tunable White            Required components:            Bender Wirth: 632b Hekla XL</p>		
<p></p> <p>LED Vesta DTW 15mm (33W)            FWHM / FWTM 37.0° / 63.0°            Efficiency 80 %            Peak intensity 1.8 cd/m            LEDs/each optic 1            Light colour Tunable White            Required components:            Bender Wirth: 632b Hekla XL</p>		
<p></p> <p>LED Vesta DTW 9mm (4W/6W/12W)            FWHM / FWTM 32.0° / 54.0°            Efficiency 87 %            Peak intensity 2.7 cd/m            LEDs/each optic 1            Light colour White            Required components:            Bender Wirth: 652b Hekla</p>		
<p><b>CITIZEN</b></p> <p>LED CLL02x/CLU02x (LES10)            FWHM / FWTM 32.0° / 55.0°            Efficiency 80 %            Peak intensity 2.3 cd/m            LEDs/each optic 1            Light colour White            Required components:            F17435_HEKLA-G2-C</p>		



#### PHOTOMETRIC DATA (MEASURED):

#### CITIZEN

LED CLU700/701/702  
 FWHM / FWTM 34.0° / 53.0°  
 Efficiency 83 %  
 Peak intensity 2.3 cd/m  
 LEDs/each optic 1  
 Light colour White  
 Required components:  
 F17435\_HEKLA-G2-C

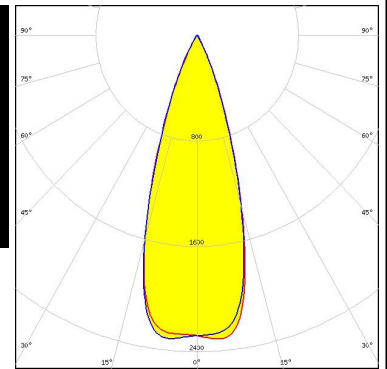
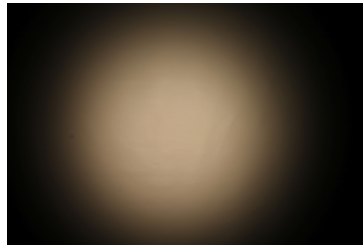

#### CITIZEN

LED CLU7A2 (LES 4.2mm)  
 FWHM / FWTM 34.0° / 52.0°  
 Efficiency 83 %  
 Peak intensity 2.3 cd/m  
 LEDs/each optic 1  
 Light colour White  
 Required components:  
 F17435\_HEKLA-G2-C

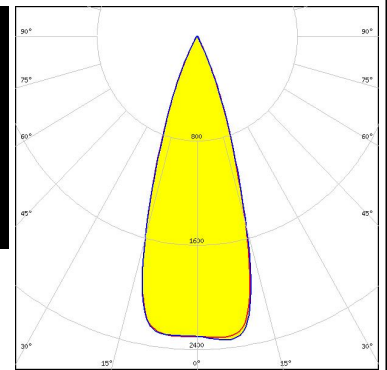
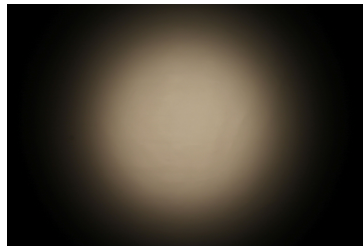

#### CITIZEN

LED CLU7B2  
 FWHM / FWTM 34.0° / 51.0°  
 Efficiency 83 %  
 Peak intensity 2.4 cd/m  
 LEDs/each optic 1  
 Light colour White  
 Required components:  
 F17435\_HEKLA-G2-C

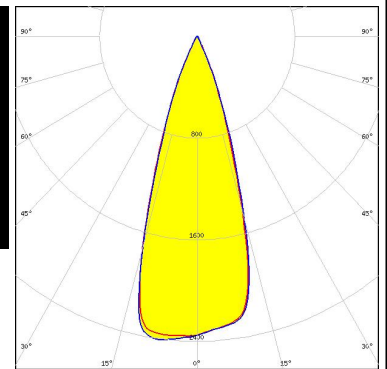
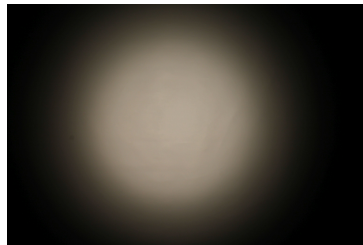





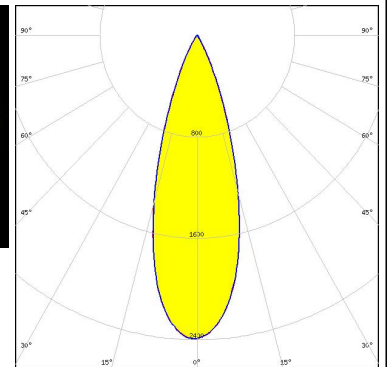
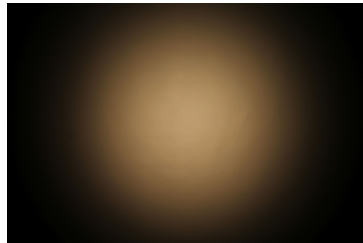

#### CREE LED

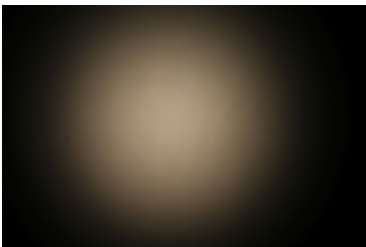
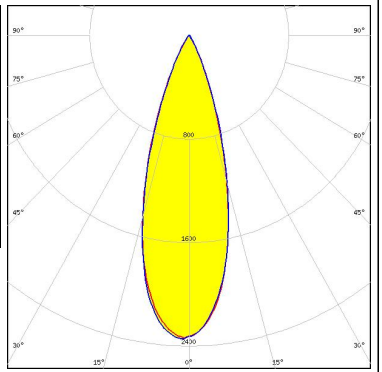

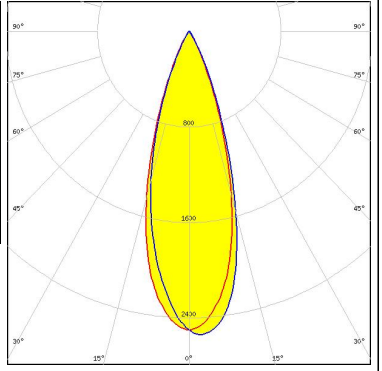

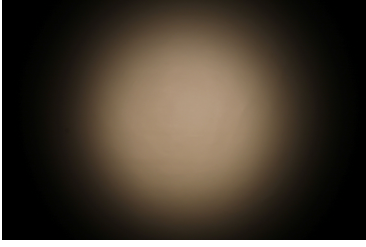
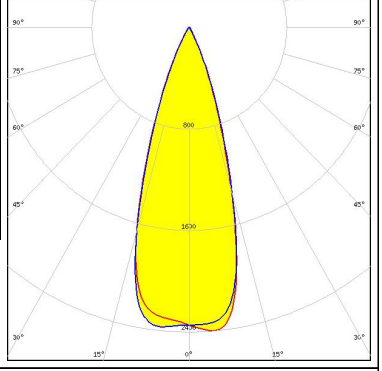

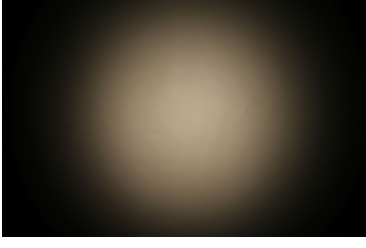
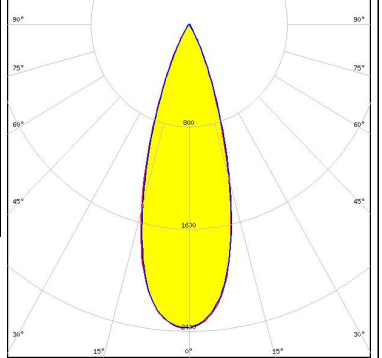
LED CMA1516  
 FWHM / FWTM 32.0° / 54.0°  
 Efficiency 81 %  
 Peak intensity 2.4 cd/m  
 LEDs/each optic 1  
 Light colour White  
 Required components:  
 F17436\_HEKLA-G2-D



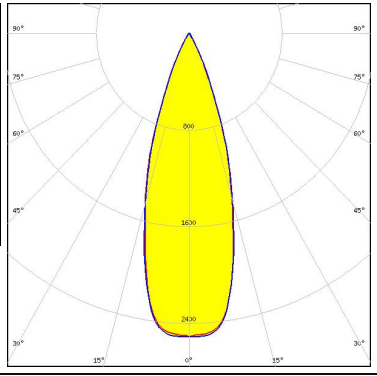

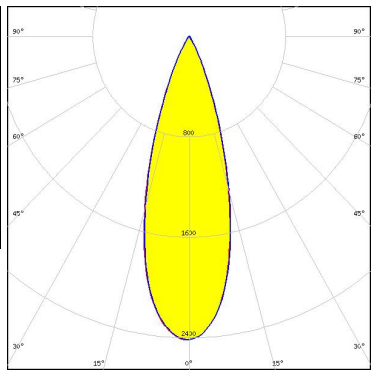

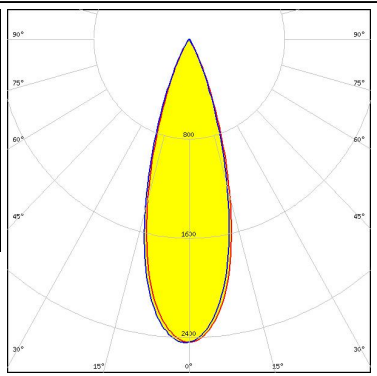

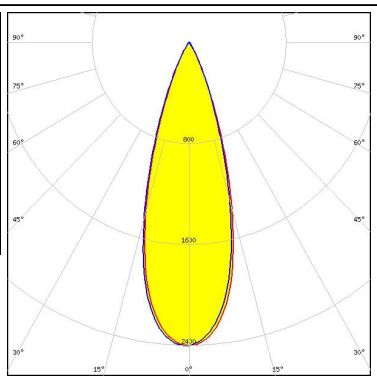
#### PHOTOMETRIC DATA (MEASURED):

<p><b>CREE</b>  <b>LED</b></p> <p>LED CMT14xx            FWHM / FWTM 32.0° / 55.0°            Efficiency 80 %            Peak intensity 2.4 cd/lm            LEDs/each optic 1            Light colour White            Required components:            F17435_HEKLA-G2-C</p>		
<p><b>CREE</b>  <b>LED</b></p> <p>LED CMU10xx            FWHM / FWTM 32.0° / 54.0°            Efficiency 86 %            Peak intensity 2.6 cd/lm            LEDs/each optic 1            Light colour White            Required components:            F17435_HEKLA-G2-C</p>		
<p><b>CREE</b>  <b>LED</b></p> <p>LED CXA/B 13xx            FWHM / FWTM 34.0° / 52.0°            Efficiency 84 %            Peak intensity 2.4 cd/lm            LEDs/each optic 1            Light colour White            Required components:            F17439_HEKLA-G2-J</p>		
<p><b>CREE</b>  <b>LED</b></p> <p>LED CXA/B 15xx            FWHM / FWTM 33.0° / 54.0°            Efficiency 81 %            Peak intensity 2.4 cd/lm            LEDs/each optic 1            Light colour White            Required components:            F17436_HEKLA-G2-D</p>		

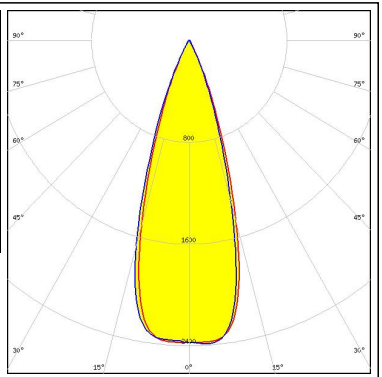
#### PHOTOMETRIC DATA (MEASURED):

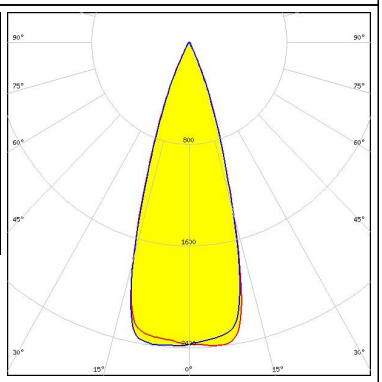
<p><b>LEDiM</b></p> <p>LED LEDIM/C6            FWHM / FWTM 33.0° / 54.0°            Efficiency 86 %            Peak intensity 2.5 cd/lm            LEDs/each optic 9            Light colour White            Required components:            F17438_HEKLA-G2-I</p>		
<p><b>LUMILEDS</b></p> <p>LED LUXEON CoB 1202/1203            FWHM / FWTM 32.0° / 54.0°            Efficiency 80 %            Peak intensity 2.4 cd/lm            LEDs/each optic 1            Light colour White            Required components:            F17437_HEKLA-G2-H</p>		
<p><b>LUMILEDS</b></p> <p>LED LUXEON CoB 1204HD            FWHM / FWTM 31.0° / 53.0°            Efficiency 80 %            Peak intensity 2.4 cd/lm            LEDs/each optic 1            Light colour White            Required components:            F17437_HEKLA-G2-H</p>		
<p><b>LUMILEDS</b></p> <p>LED LUXEON CoB M02/M03            FWHM / FWTM 32.0° / 54.0°            Efficiency 81 %            Peak intensity 2.4 cd/lm            LEDs/each optic 1            Light colour White            Required components:            F17436_HEKLA-G2-D</p>		

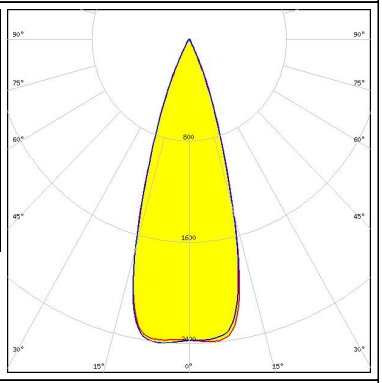
#### PHOTOMETRIC DATA (MEASURED):

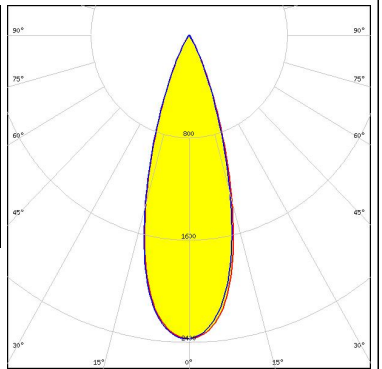
<p><b>LUMILEDS</b></p> <p>LED LUXEON CoB S01</p> <p>FWHM / FWTM 34.0° / 52.0°</p> <p>Efficiency 83 %</p> <p>Peak intensity 2.4 cd/m</p> <p>LEDs/each optic 1</p> <p>Light colour White</p> <p>Required components: F17439_HEKLA-G2-J</p>		
<p><b>LUMINUS</b></p> <p>LED CXM-3</p> <p>FWHM / FWTM 33.0° / 51.0°</p> <p>Efficiency 83 %</p> <p>Peak intensity 2.4 cd/m</p> <p>LEDs/each optic 1</p> <p>Light colour White</p> <p>Required components: F17435_HEKLA-G2-C</p>		
<p><b>LUMINUS</b></p> <p>LED CXM-4</p> <p>FWHM / FWTM 33.0° / 51.0°</p> <p>Efficiency 83 %</p> <p>Peak intensity 2.4 cd/m</p> <p>LEDs/each optic 1</p> <p>Light colour White</p> <p>Required components: F17435_HEKLA-G2-C</p>		
<p><b>NICHIA</b></p> <p>LED COB L-Type (LES 9)</p> <p>FWHM / FWTM 32.0° / 54.0°</p> <p>Efficiency 80 %</p> <p>Peak intensity 2.4 cd/m</p> <p>LEDs/each optic 1</p> <p>Light colour White</p> <p>Required components: F17437_HEKLA-G2-H</p>		



#### PHOTOMETRIC DATA (MEASURED):



LED COB S-Type (LES 7)  
 FWHM / FWTM 34.0° / 54.0°  
 Efficiency 83 %  
 Peak intensity 2.3 cd/lm  
 LEDs/each optic 1  
 Light colour White  
 Required components:  
 F15848\_HEKLA-SOCKET-G

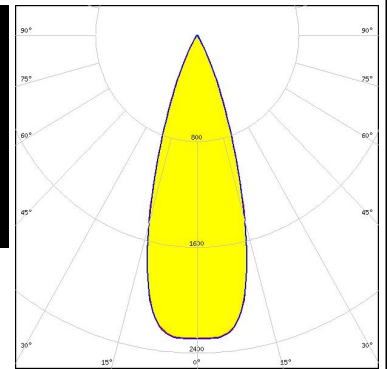
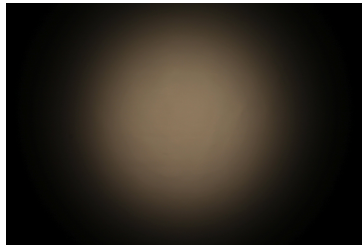

LED Fortimo SLM L09 CoB  
 FWHM / FWTM 32.0° / 53.0°  
 Efficiency 80 %  
 Peak intensity 2.4 cd/lm  
 LEDs/each optic 1  
 Light colour White  
 Required components:  
 F17437\_HEKLA-G2-H

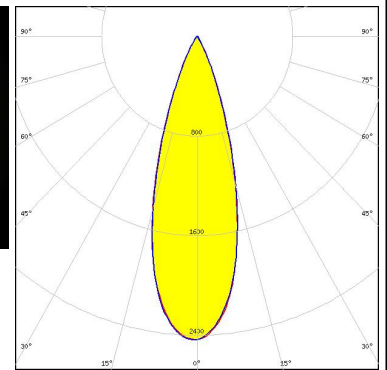
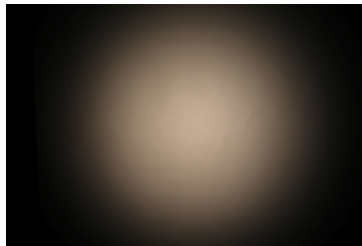

LED LC003D / LC006D / LC009D / LC013D  
 FWHM / FWTM 32.0° / 55.0°  
 Efficiency 80 %  
 Peak intensity 2.3 cd/lm  
 LEDs/each optic 1  
 Light colour White  
 Required components:  
 F17435\_HEKLA-G2-C

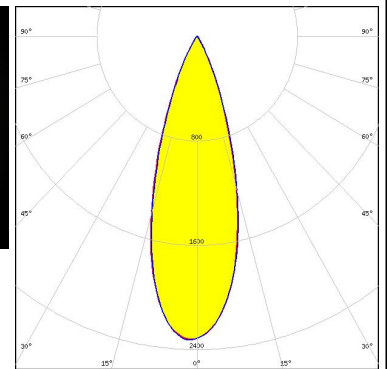
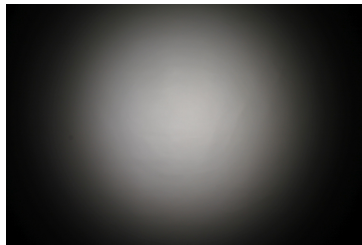



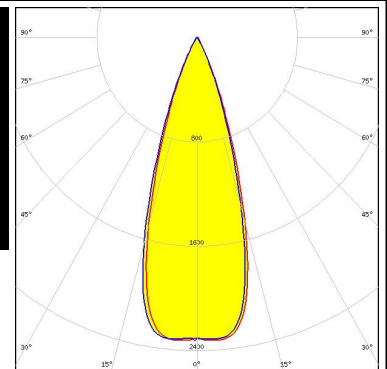

SEOL SEMICONDUCTOR  
 LED MJT COB LES 6  
 FWHM / FWTM 34.0° / 53.0°  
 Efficiency 83 %  
 Peak intensity 2.3 cd/lm  
 LEDs/each optic 1  
 Light colour White  
 Required components:  
 F17435\_HEKLA-G2-C



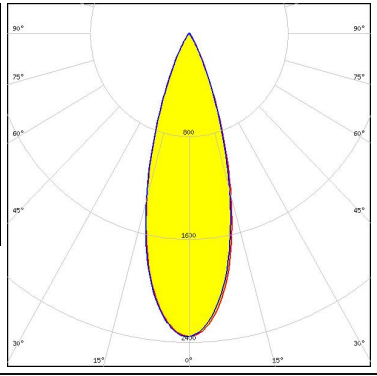

#### PHOTOMETRIC DATA (MEASURED):

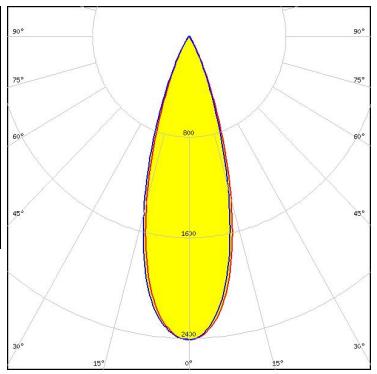
<p> SEOUL SEMICONDUCTOR</p> <p>LED MJT COB LES 9.8 FWHM / FWTM 32.0° / 55.0° Efficiency 80 % Peak intensity 2.4 cd/lm LEDs/each optic 1 Light colour White Required components: F17435_HEKLA-G2-C</p>		
<p><b>TRIDONIC</b></p> <p>LED SLE G7 LES09 FWHM / FWTM 32.0° / 54.0° Efficiency 81 % Peak intensity 2.4 cd/lm LEDs/each optic 1 Light colour White Required components: F17435_HEKLA-G2-C</p>		

#### PHOTOMETRIC DATA (SIMULATED):

<p><b>bridgelux.</b></p> <p>LED: V6 HD            FWHM / FWTM: 38.0° / 54.0°            Efficiency: 90 %            Peak intensity: 2.3 cd/lm            LEDs/each optic: 1            Light colour: White            Required components:            F17435_HEKLA-G2-C</p>	
<p><b>bridgelux.</b></p> <p>LED: Vero SE 13            FWHM / FWTM: 30.0° / 52.0°            Efficiency: 74 %            Peak intensity: 2.4 cd/lm            LEDs/each optic: 1            Light colour: White            Required components:            C16142_HEKLA-SOCKET-K</p>	
<p><b>PHILIPS</b></p> <p>LED: Fortimo SLM L15 CoB            FWHM / FWTM: 37.0° / 62.0°            Efficiency: 81 %            Peak intensity: 1.9 cd/lm            LEDs/each optic: 1            Light colour: White            Required components:            Bender Wirth: 632a Hekla XL</p>	
<p><b>PHILIPS</b></p> <p>LED: Fortimo SLM L15 CoB            FWHM / FWTM: 38.0° / 64.0°            Efficiency: 79 %            Peak intensity: 1.8 cd/lm            LEDs/each optic: 1            Light colour: White            Required components:            Bender Wirth: 632a Hekla XL</p>	

#### PHOTOMETRIC DATA (SIMULATED):

#### TRIDONIC

LED	SLE G7 LES13
FWHM / FWTM	36.0° / 60.0°
Efficiency	83 %
Peak intensity	2.1 cd/lm
LEDs/each optic	1
Light colour	White
Required components:	
	F17438_HEKLA-G2-I

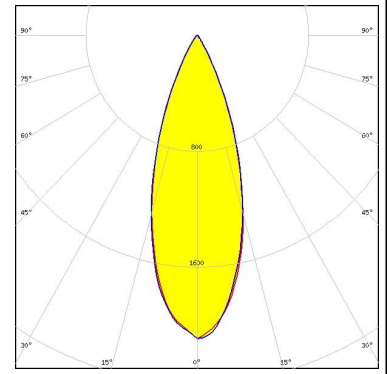

#### GENERAL INFORMATION:

NOTE: The typical beam angle will be changed by different color, chip size and chip position tolerance. The typical total beam angle is the full angle measured where the luminous intensity is half of the peak value.

Due to use of high power COB's with this product, special attention to proper thermal design is highly recommended. LEDiL has no liability for direct, indirect or consecutive damages arising from the LEDiL products being used outside of the recommended temperature range.

#### MATERIALS:

As part of our continuous research and improvement processes, and to ensure the best possible quality and availability of our products, LEDiL reserves the right to change material grades without notice.

#### PRODUCT DATA USER AGREEMENT AND DISCLAIMER:

The measured data in the provided downloadable LEDiL Product Datasheets and Mechanical 2D-Drawings is rounded and provided as reference for planning. LEDiL Oy's optical specifications have been verified by conducting performance testing of the products in accordance with the company's quality system. The reported data are averaged results of multiple measurements with typical variation. LEDiL Oy reserves the right to without prior notification make changes and improvements to its products.

LEDiL Oy assumes neither warranty, nor guarantee nor any other liability of any kind for the contents and correctness of the provided data. The provided data has been generated with highest diligence but the provided data may in reality not represent the complete possible variation range of all intrinsic parameters. Therefore, in certain cases a deviation from the provided data could occur.

LEDiL Oy reserves the right to undertake technical changes of its products without further notification which could lead to changes in the provided data. LEDiL Oy assumes no liability of any kind for the possible deviation from any provided data or any other damage resulting from the usage of the provided data.

The user agrees to this disclaimer and user agreement with the download or usage of the provided files.

#### LEDiL Oy

Joensuunkatu 13  
FI-24240 SALO  
Finland

#### LEDiL Inc.

228 West Page Street  
Suite D  
Sycamore IL 60178  
USA

#### Ledil Optics Technology (Shenzhen) Co., Ltd.

# 405 , Block B  
Casic Motor Building  
Shenzhen 518057  
P.R.CHINA

#### Local sales and technical support

[www.ledil.com/  
where\\_to\\_buy](http://www.ledil.com/where_to_buy)

#### Shipping locations

Salo, Finland  
Hong Kong, China

#### Distribution Partners

[www.ledil.com/  
where\\_to\\_buy](http://www.ledil.com/where_to_buy)