

YASMEEN-70-S-C-WHT

~15° spot beam. Assembly with holder C compatible with HEKLA sockets and connectors. White version.

TECHNICAL SPECIFICATIONS:

Dimensions	Ø 69.9 mm
Height	39.9 mm
ROHS compliant	yes ⓘ



MATERIAL SPECIFICATIONS:

Component	Type	Material	Colour	Finish
YASMEEN-70-S	Single lens	PMMA	clear	
YASMEEN-70-HLD-C-WHT	Holder	PC	white	

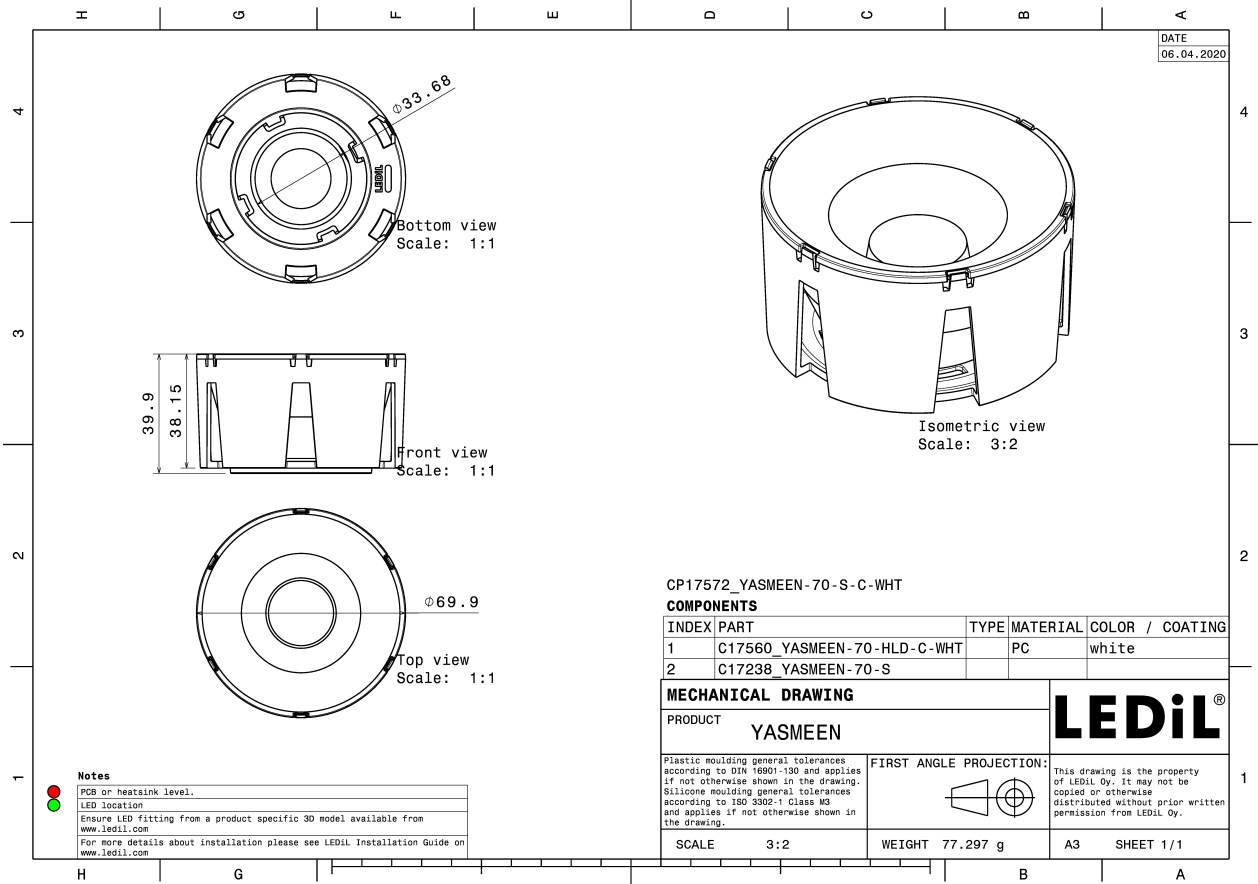

ORDERING INFORMATION:

Component	Type	Qty in box	MOQ	MPQ	Box weight (kg)
CP17572_YASMEEN-70-S-C-WHT » Box size: 476 x 273 x 305 mm	Single lens	105	105	15	9.8

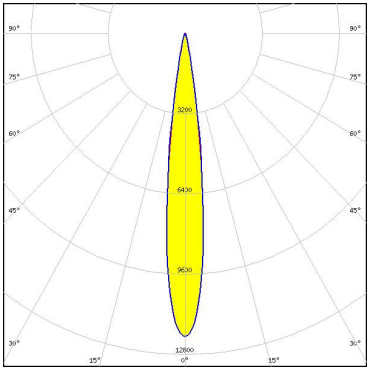

See also our general installation guide: www.ledil.com/installation_guide

PHOTOMETRIC DATA (MEASURED):

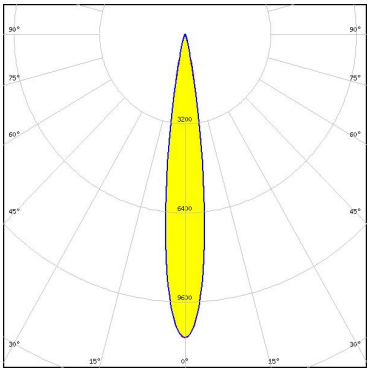
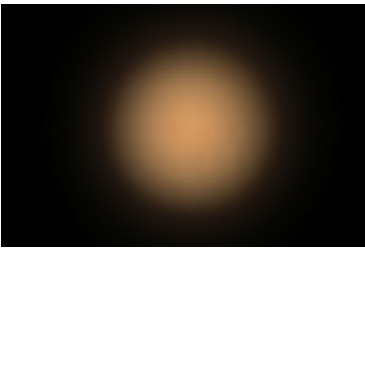
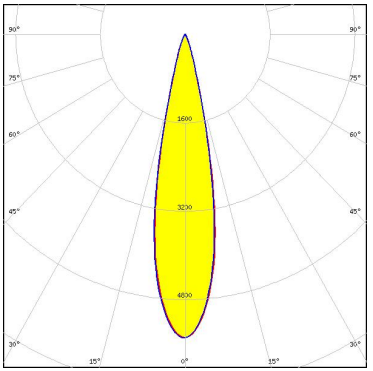
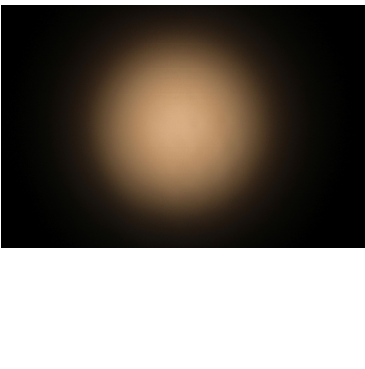
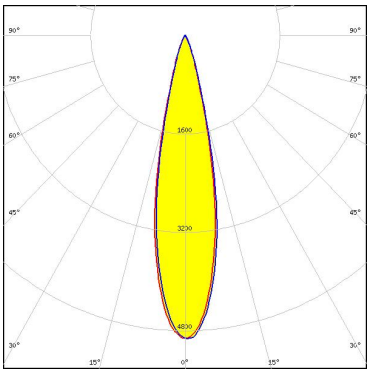
<p>bridgelux.</p> <p>LED V9 HD</p> <p>FWHM / FWTM 13.0° / 24.0°</p> <p>Efficiency 92 %</p> <p>Peak intensity 12.1 cd/lm</p> <p>LEDs/each optic 1</p> <p>Light colour White</p> <p>Required components: F15859_HEKLA-SOCKET-I</p>		
<p>bridgelux.</p> <p>LED VERO10</p> <p>FWHM / FWTM 14.0° / 25.0°</p> <p>Efficiency 93 %</p> <p>Peak intensity 10.9 cd/lm</p> <p>LEDs/each optic 1</p> <p>Light colour White</p> <p>Required components: F15616_HEKLA-SOCKET-F</p>		
<p>bridgelux.</p> <p>LED Vesta DTW 13mm (21W)</p> <p>FWHM / FWTM 22.0° / 36.0°</p> <p>Efficiency 92 %</p> <p>Peak intensity 5.5 cd/lm</p> <p>LEDs/each optic 1</p> <p>Light colour Tunable White</p> <p>Required components: Bender Wirth: 632b Hekla</p>		
<p>bridgelux.</p> <p>LED Vesta DTW 15mm (33W)</p> <p>FWHM / FWTM 23.0° / 39.0°</p> <p>Efficiency 92 %</p> <p>Peak intensity 4.9 cd/lm</p> <p>LEDs/each optic 1</p> <p>Light colour Tunable White</p> <p>Required components: Bender Wirth: 632b Hekla</p>		

PHOTOMETRIC DATA (MEASURED):



LED Vesta DTW 9mm (4W/6W/12W)
 FWHM / FWTM 15.0° / 25.0°
 Efficiency 93 %
 Peak intensity 11 cd/lm
 LEDs/each optic 1
 Light colour Tunable White
 Required components:
 Bender Wirth: 652b Hekla

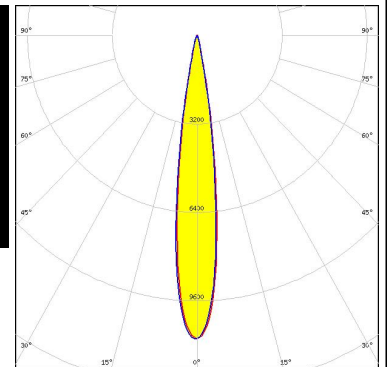

CITIZEN

LED CLL02x/CLU02x (LES10)
 FWHM / FWTM 15.5° / 26.5°
 Efficiency 92 %
 Peak intensity 10 cd/lm
 LEDs/each optic 1
 Light colour White
 Required components:
 F17435_HEKLA-G2-C

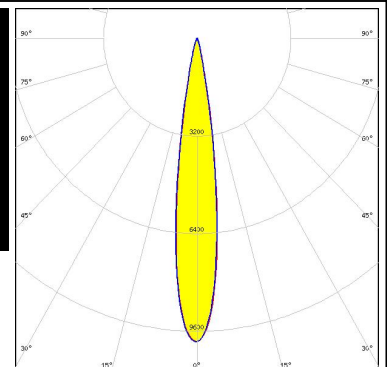
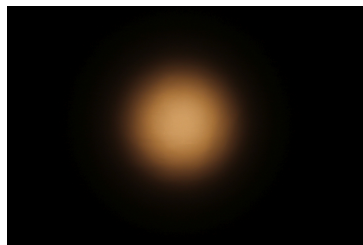

CITIZEN

LED CLL03x/CLU03x
 FWHM / FWTM 21.0° / 37.0°
 Efficiency 92 %
 Peak intensity 5.6 cd/lm
 LEDs/each optic 1
 Light colour White
 Required components:
 F17438_HEKLA-G2-I

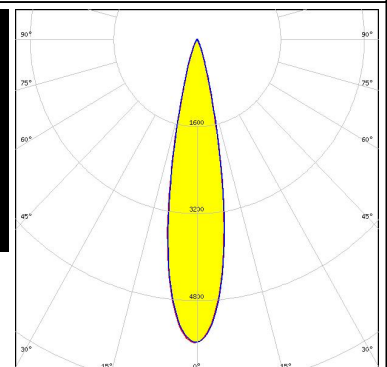

LED CMA1516
 FWHM / FWTM 14.0° / 25.0°
 Efficiency 93 %
 Peak intensity 10.9 cd/lm
 LEDs/each optic 1
 Light colour White
 Required components:
 F17436_HEKLA-G2-D

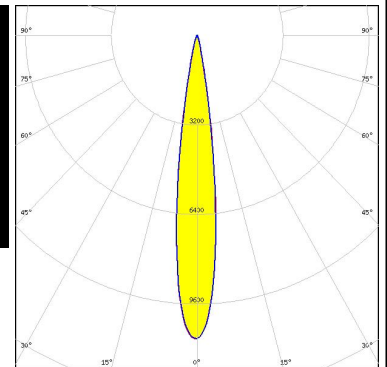
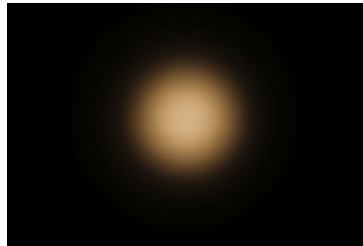

PHOTOMETRIC DATA (MEASURED):

CREE LED

LED CMA1825
 FWHM / FWTM 19.0° / 32.0°
 Efficiency 93 %
 Peak intensity 6.9 cd/lm
 LEDs/each optic 1
 Light colour White
 Required components:
 F15254_HEKLA-SOCKET-B

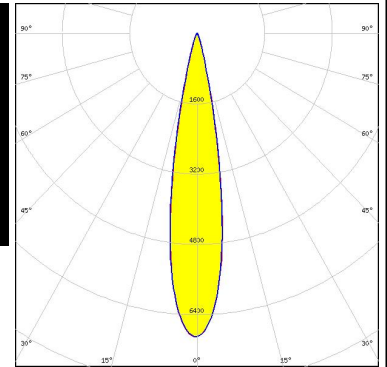

CREE LED

LED CMT14xx
 FWHM / FWTM 15.0° / 26.0°
 Efficiency 92 %
 Peak intensity 10.1 cd/lm
 LEDs/each optic 1
 Light colour White
 Required components:
 F17435_HEKLA-G2-C

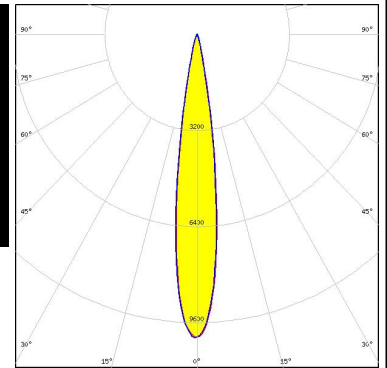

CREE LED

LED CMT19xx
 FWHM / FWTM 21.0° / 36.0°
 Efficiency 92 %
 Peak intensity 5.4 cd/lm
 LEDs/each optic 1
 Light colour White
 Required components:
 F17438_HEKLA-G2-I

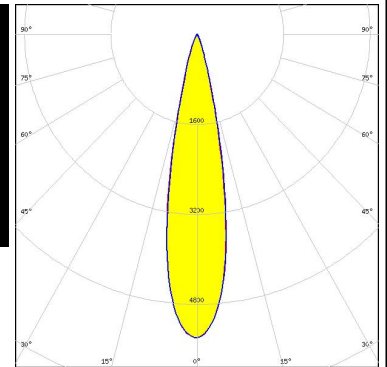

LUMILEDS

LED LUXEON CoB 1202/1203
 FWHM / FWTM 14.0° / 24.0°
 Efficiency 92 %
 Peak intensity 11.2 cd/lm
 LEDs/each optic 1
 Light colour White
 Required components:
 F17437_HEKLA-G2-H

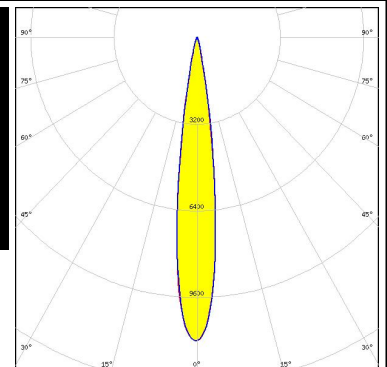

PHOTOMETRIC DATA (MEASURED):



LED COB L-Type (LES 9)
 FWHM / FWTM 13.0° / 24.0°
 Efficiency 92 %
 Peak intensity 11.9 cd/lm
 LEDs/each optic 1
 Light colour White
 Required components:
 F17437_HEKLA-G2-H

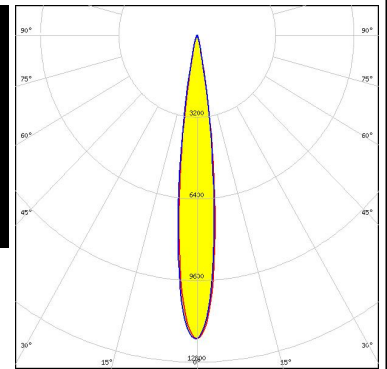
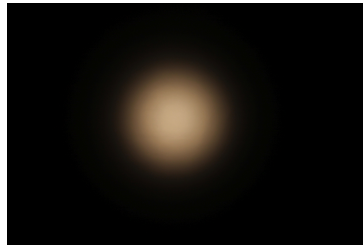

LED COB S-Type (LES 7)
 FWHM / FWTM 20.0° / 34.0°
 Efficiency 92 %
 Peak intensity 6.1 cd/lm
 LEDs/each optic 1
 Light colour White
 Required components:
 F17438_HEKLA-G2-I

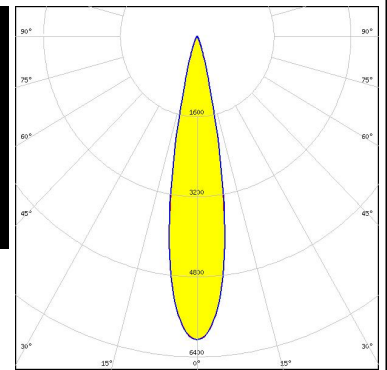

LED Fortimo SLM L09 CoB
 FWHM / FWTM 14.0° / 25.0°
 Efficiency 92 %
 Peak intensity 11.1 cd/lm
 LEDs/each optic 1
 Light colour White
 Required components:
 F17437_HEKLA-G2-H

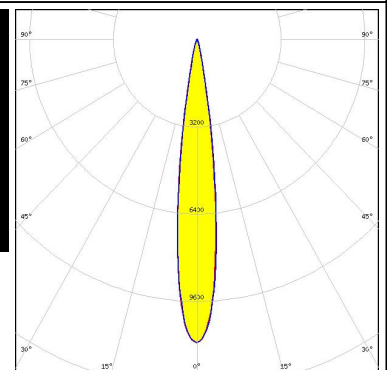

LED LC016D / LC019D / LC026D / LC033D
 FWHM / FWTM 23.0° / 40.0°
 Efficiency 92 %
 Peak intensity 4.8 cd/lm
 LEDs/each optic 1
 Light colour White
 Required components:
 F17438_HEKLA-G2-I

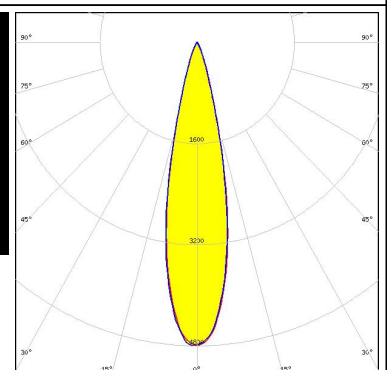
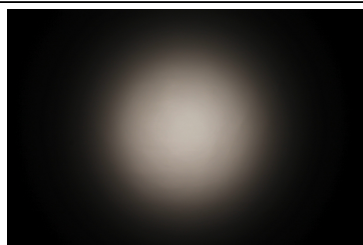

PHOTOMETRIC DATA (MEASURED):

SAMSUNG

LED LC030C/040C G2
 FWHM / FWTM 17.0° / 30.0°
 Efficiency 92 %
 Peak intensity 7.7 cd/lm
 LEDs/each optic 1
 Light colour White
 Required components:
 F17438_HEKLA-G2-I

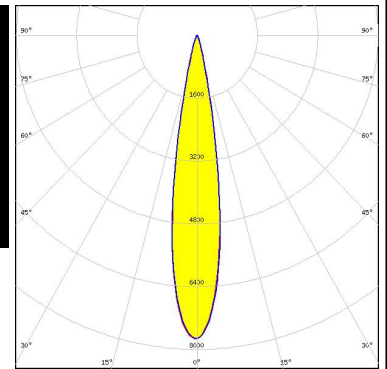

LED MJT COB LES 14.5
 FWHM / FWTM 23.0° / 39.0°
 Efficiency 92 %
 Peak intensity 4.9 cd/lm
 LEDs/each optic 1
 Light colour White
 Required components:
 F17438_HEKLA-G2-I

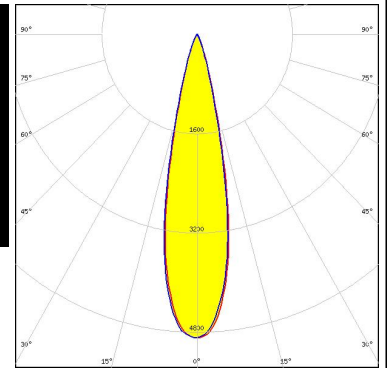
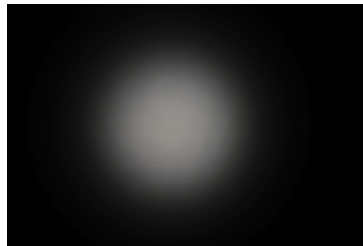

TRIDONIC

LED SLE G7 LES09
 FWHM / FWTM 15.0° / 25.0°
 Efficiency 93 %
 Peak intensity 11.3 cd/lm
 LEDs/each optic 1
 Light colour White
 Required components:
 F17435_HEKLA-G2-C

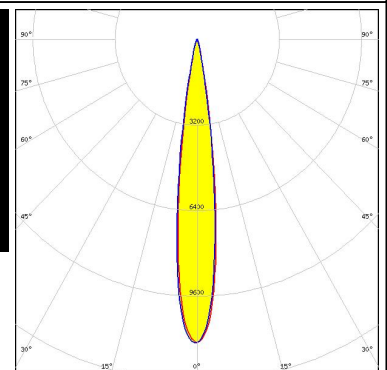

TRIDONIC

LED SLE G7 LES15
 FWHM / FWTM 22.0° / 38.0°
 Efficiency 92 %
 Peak intensity 5.1 cd/lm
 LEDs/each optic 1
 Light colour White
 Required components:
 F17438_HEKLA-G2-I

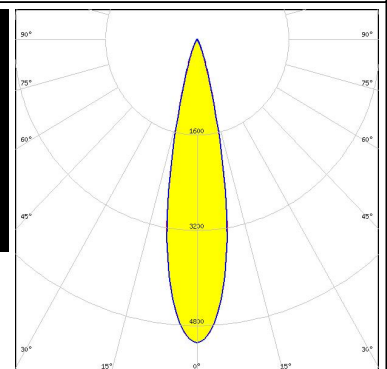

PHOTOMETRIC DATA (SIMULATED):

CITIZEN

LED CLU712
FWHM / FWTM 14.0° / 26.0°
Efficiency 93 %
Peak intensity 11.3 cd/lm
LEDs/each optic 1
Light colour White
Required components:
F17438_HEKLA-G2-I

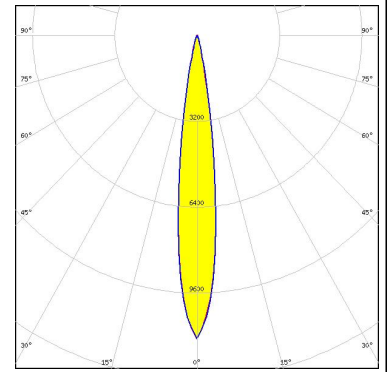

GENERAL INFORMATION:

NOTE: The typical beam angle will be changed by different color, chip size and chip position tolerance. The typical total beam angle is the full angle measured where the luminous intensity is half of the peak value.

Due to use of high power COB's with this product, special attention to proper thermal design is highly recommended. LEDiL has no liability for direct, indirect or consecutive damages arising from the LEDiL products being used outside of the recommended temperature range.

MATERIALS:

As part of our continuous research and improvement processes, and to ensure the best possible quality and availability of our products, LEDiL reserves the right to change material grades without notice.

PRODUCT DATA USER AGREEMENT AND DISCLAIMER:

The measured data in the provided downloadable LEDiL Product Datasheets and Mechanical 2D-Drawings is rounded and provided as reference for planning. LEDiL Oy's optical specifications have been verified by conducting performance testing of the products in accordance with the company's quality system. The reported data are averaged results of multiple measurements with typical variation. LEDiL Oy reserves the right to without prior notification make changes and improvements to its products.

LEDiL Oy assumes neither warranty, nor guarantee nor any other liability of any kind for the contents and correctness of the provided data. The provided data has been generated with highest diligence but the provided data may in reality not represent the complete possible variation range of all intrinsic parameters. Therefore, in certain cases a deviation from the provided data could occur.

LEDiL Oy reserves the right to undertake technical changes of its products without further notification which could lead to changes in the provided data. LEDiL Oy assumes no liability of any kind for the possible deviation from any provided data or any other damage resulting from the usage of the provided data.

The user agrees to this disclaimer and user agreement with the download or usage of the provided files.

LEDiL Oy

Joensuunkatu 13
FI-24240 SALO
Finland

LEDiL Inc.

228 West Page Street
Suite D
Sycamore IL 60178
USA

Ledil Optics Technology (Shenzhen) Co., Ltd.

405 , Block B
Casic Motor Building
Shenzhen 518057
P.R.CHINA

Local sales and technical support

[www.ledil.com/
where_to_buy](http://www.ledil.com/where_to_buy)

Shipping locations

Salo, Finland
Hong Kong, China

Distribution Partners

[www.ledil.com/
where_to_buy](http://www.ledil.com/where_to_buy)