

STRADA-DW

Soft wide beam with good illuminance uniformity optimized for CREE XP-G and XP-E. Assembly with installation tape.

SPECIFICATION:

Dimensions	19.6 x 15.5 mm
Height	9 mm
Fastening	tape, pin, screw
ROHS compliant	yes ⓘ



MATERIALS:

Component	Type	Material	Colour	Finish
STRADA-DW	Single lens	PMMA	clear	
VOSU-WU-M-365-TAPE	Tape	Acrylic foam		





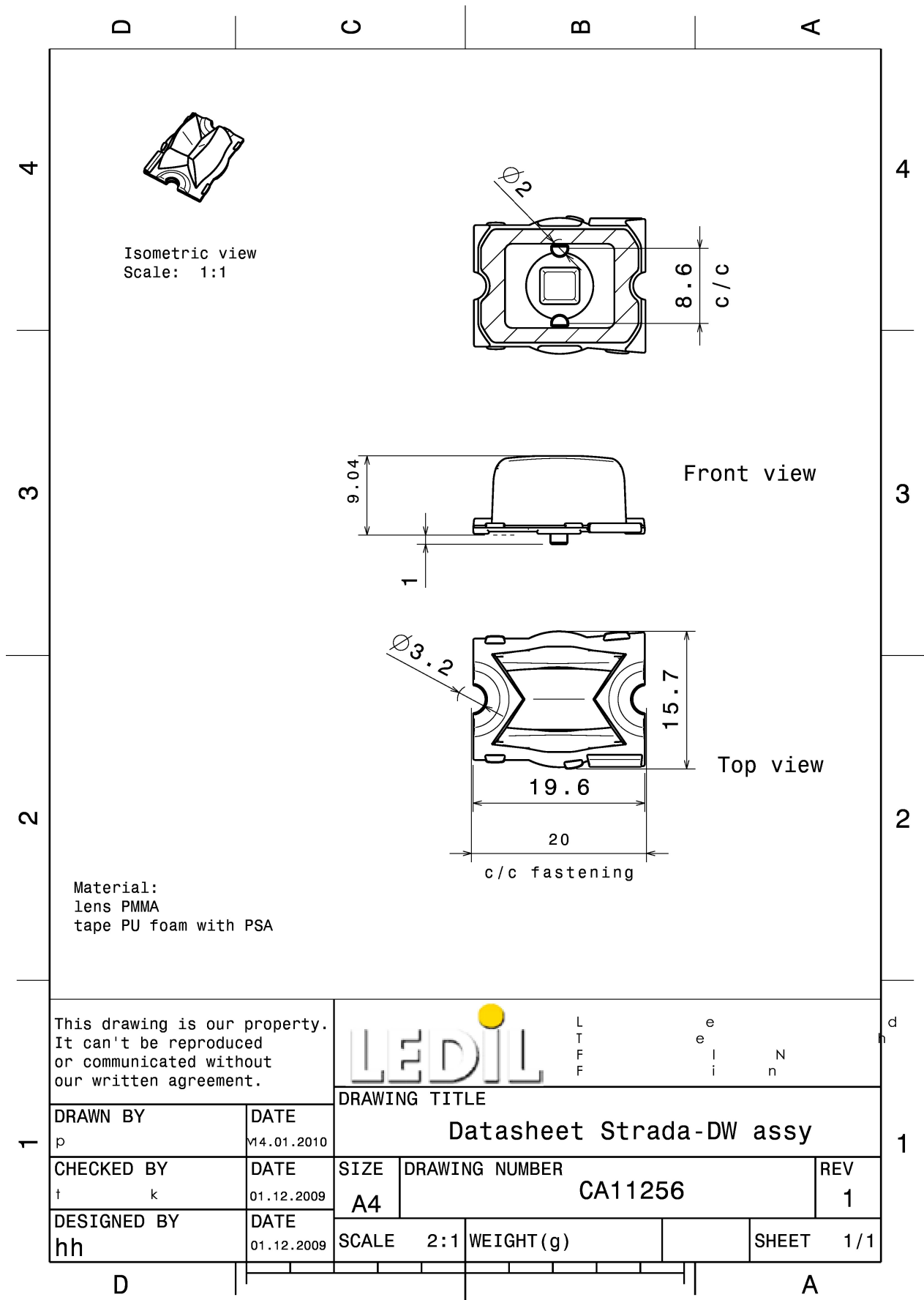

ORDERING INFORMATION:

Component	Type	Qty in box	MOQ	MPQ	Box weight (kg)
CA11256_STRADA-DW » Box size: 451 x 273 x 197 mm	Single lens	3120	240	240	4.3

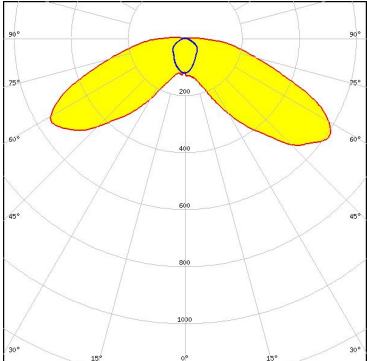

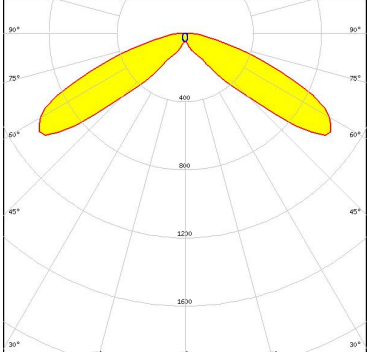
See also our general installation guide: www.ledil.com/installation_guide

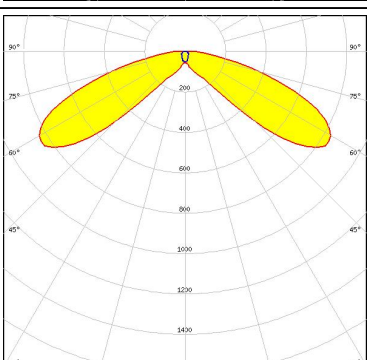
OPTICAL RESULTS (MEASURED):

<p> bridgelux</p> <p>LED Bridgelux SMD 5050</p> <p>FWHM / FWTM Asymmetric</p> <p>Efficiency 94 %</p> <p>Peak intensity 0.6 cd/lm</p> <p>LEDs/each optic 1</p> <p>Light colour White</p> <p>Required components:</p>	
<p> CREE LEDs</p> <p>LED XP-E</p> <p>FWHM / FWTM 90.0 + 140.0°</p> <p>Efficiency 92 %</p> <p>Peak intensity 1 cd/lm</p> <p>LEDs/each optic 1</p> <p>Light colour White</p> <p>Required components:</p>	
<p> CREE LEDs</p> <p>LED XP-G</p> <p>FWHM / FWTM 88.0 + 148.0°</p> <p>Efficiency 92 %</p> <p>Peak intensity 0.8 cd/lm</p> <p>LEDs/each optic 1</p> <p>Light colour White</p> <p>Required components:</p>	
<p> LUMILEDS</p> <p>LED LUXEON A</p> <p>FWHM / FWTM 86.0 + 140.0°</p> <p>Efficiency 92 %</p> <p>LEDs/each optic 1</p> <p>Light colour White</p> <p>Required components:</p>	

OPTICAL RESULTS (MEASURED):

LUMILEDS

LED LUXEON Rebel
 FWHM / FWTM 86.0 + 140.0°
 Efficiency 92 %
 Peak intensity 1 cd/m
 LEDs/each optic 1
 Light colour White
 Required components:

LUMILEDS

LED LUXEON Rebel ES
 FWHM / FWTM 86.0 + 140.0°
 Efficiency 92 %
 LEDs/each optic 1
 Light colour White
 Required components:

LUMILEDS

LED LUXEON T
 FWHM / FWTM 86.0 + 144.0°
 Efficiency 93 %
 Peak intensity 0.9 cd/m
 LEDs/each optic 1
 Light colour White
 Required components:

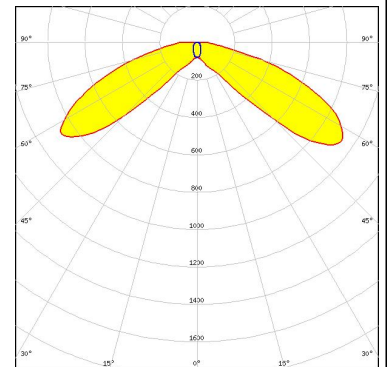

LUMILEDS

LED LUXEON TX
 FWHM / FWTM 54.0 + 144.0° / 162.0 + 174.0°
 Efficiency 94 %
 Peak intensity 1 cd/m
 LEDs/each optic 1
 Light colour White
 Required components:

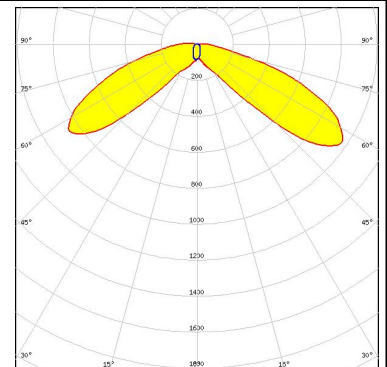

OPTICAL RESULTS (MEASURED):



LED NCSxx19A
FWHM / FWTM 86.0 + 148.0°
Efficiency 92 %
LEDs/each optic 1
Light colour White
Required components:



LED NVSW219D
FWHM / FWTM 141.0 + 57.0° / 176.0 + 149.0°
Efficiency 94 %
Peak intensity 0.9 cd/lm
LEDs/each optic 1
Light colour White
Required components:

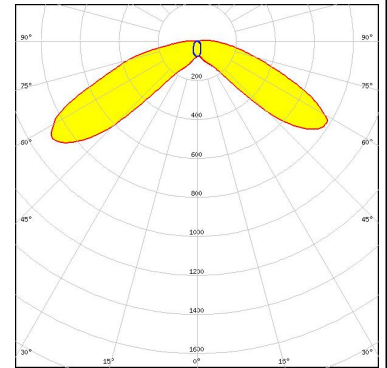

LED NVSxx19A
FWHM / FWTM 86.0 + 148.0°
Efficiency 92 %
LEDs/each optic 1
Light colour White
Required components:



LED OSLOM SSL 150
FWHM / FWTM 92.0 + 142.0°
Efficiency 92 %
LEDs/each optic 1
Light colour White
Required components:

OPTICAL RESULTS (MEASURED):

OSRAM

Opto Semiconductors

LED OSLON SSL 80
FWHM / FWTM 92.0 + 142.0°
Efficiency 92 %
Peak intensity 1 cd/lm
LEDs/each optic 1
Light colour White
Required components:

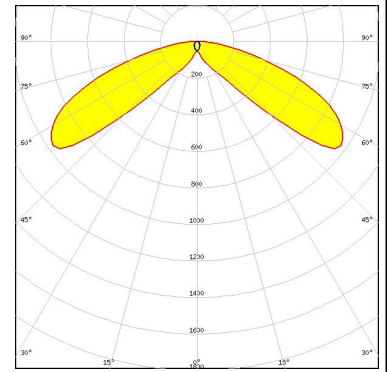

OPTICAL RESULTS (SIMULATED):



LED XP-E2
 FWHM / FWTM 87.0 + 135.0° / 54.0 + 156.0°
 Efficiency 94 %
 Peak intensity 1.5 cd/lm
 LEDs/each optic 1
 Light colour White
 Required components:

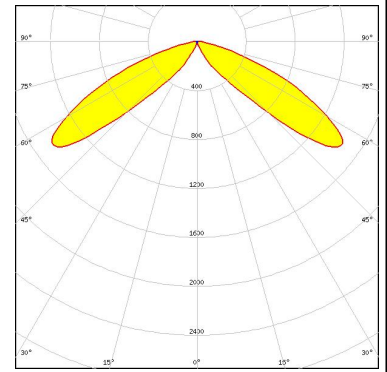

LED LUXEON H50-2
 FWHM / FWTM 80.0 + 136.0° / 38.0 + 160.0°
 Efficiency 93 %
 Peak intensity 1.1 cd/lm
 LEDs/each optic 1
 Light colour White
 Required components:

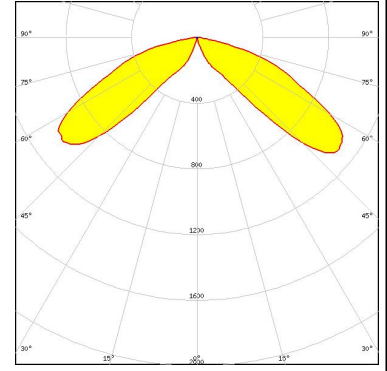

LED NVSxx19B/NVSxx19C
 FWHM / FWTM 80.0 + 140.0°
 Efficiency 94 %
 Peak intensity 1 cd/lm
 LEDs/each optic 1
 Light colour White
 Required components:

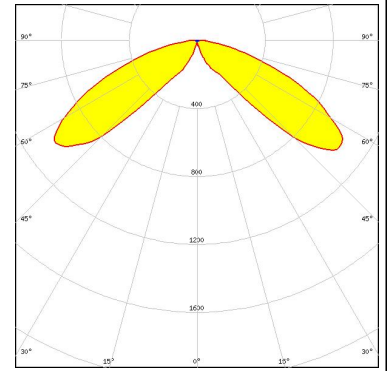

LED LH351B
 FWHM / FWTM Asymmetric
 Efficiency 96 %
 Peak intensity 1.1 cd/lm
 LEDs/each optic 1
 Light colour White
 Required components:

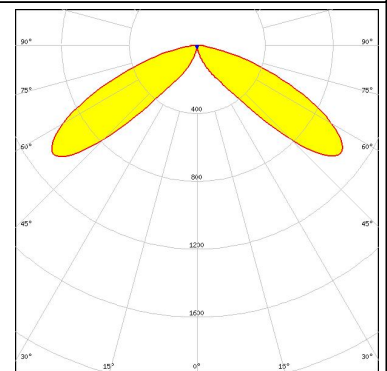

OPTICAL RESULTS (SIMULATED):

 SEOL SEMICONDUCTOR	
LED	Z5
FWHM / FWTM	86.0 + 141.0°
Efficiency	%
LEDs/each optic	1
Light colour	White
Required components:	
SHARP	
LED	Double Dome (GM2BB)
FWHM / FWTM	86.0 + 141.0°
Efficiency	%
LEDs/each optic	1
Light colour	White
Required components:	

GENERAL INFORMATION:

NOTE: The typical beam angle will be changed by different color, chip size and chip position tolerance. The typical total beam angle is the full angle measured where the luminous intensity is half of the peak value.

MATERIALS:

As part of our continuous research and improvement processes, and to ensure the best possible quality and availability of our products, LEDiL reserves the right to change material grades without notice.

PRODUCT DATA USER AGREEMENT AND DISCLAIMER:

The measured data in the provided downloadable LEDiL Product Datasheets and Mechanical 2D-Drawings is rounded and provided as reference for planning. LEDiL Oy's optical specifications have been verified by conducting performance testing of the products in accordance with the company's quality system. The reported data are averaged results of multiple measurements with typical variation. LEDiL Oy reserves the right to without prior notification make changes and improvements to its products.

LEDiL Oy assumes neither warranty, nor guarantee nor any other liability of any kind for the contents and correctness of the provided data. The provided data has been generated with highest diligence but the provided data may in reality not represent the complete possible variation range of all intrinsic parameters. Therefore, in certain cases a deviation from the provided data could occur.

LEDiL Oy reserves the right to undertake technical changes of its products without further notification which could lead to changes in the provided data. LEDiL Oy assumes no liability of any kind for the possible deviation from any provided data or any other damage resulting from the usage of the provided data.

The user agrees to this disclaimer and user agreement with the download or usage of the provided files.

LEDiL Oy

Joensuunkatu 13
FI-24240 SALO
Finland

LEDiL Inc.

228 West Page Street
Suite D
Sycamore IL 60178
USA

Ledil Optics Technology (Shenzhen) Co., Ltd.

405 , Block B
Casic Motor Building
Shenzhen 518057
P.R.CHINA

Local sales and technical support

[www.ledil.com/
where_to_buy](http://www.ledil.com/where_to_buy)

Shipping locations

Salo, Finland
Hong Kong, China

Distribution Partners

[www.ledil.com/
where_to_buy](http://www.ledil.com/where_to_buy)