Fixed and Adjustable Current Limiting Power Distribution Switches

Features

MIC20X3 - MIC20X9

- 70 mΩ Typical On-Resistance @ 5V

MIC2005A/20X9A

- 170 mΩ Typical On-Resistance @ 5V
- Enable Active-High or Active-Low
- 2.5V to 5.5V Operating Range
- Pre-Set Current Limit Values of 0.5A, 0.8A, and 1.2A*
- Adjustable Current Limit 0.2A to 2.0A* (MIC20X7-MIC20X9)
- Adjustable Current Limit 0.1A to 0.9A* (MIC20X9A)
- Undervoltage Lockout (UVLO)
- Variable UVLO Allows Adjustable UVLO Thresholds*
- Automatic Load Discharge for Capacitive Loads*
- Soft-Start Prevents Large Current Inrush
- Adjustable Slew Rate Allows Custom Slew Rates*
- Automatic-On Output After Fault
- Thermal Protection

* Available on some family members

Applications

- Digital Televisions (DTV)
- Set Top Boxes
- PDAs
- Printers
- USB / IEEE 1394 Power Distribution
- Desktop and Laptop PCs
- Game Consoles
- Docking Stations

General Description

The MIC20XX family of switches are current limiting, high-side power switches, designed for general purpose power distribution and control in digital televisions (DTV), printers, set top boxes (STB), PCs, PDAs, and other peripheral devices (see [MIC20XX Family Package Types](#) and the [MIC20XX Family Member Functionality](#) table).

MIC20XX family's primary functions are current limiting and power switching. They are thermally protected and will shutdown should their internal temperature reach unsafe levels, protecting both the device and the load, under high-current or fault conditions.

Features include fault reporting, fault blanking to eliminate noise-induced false alarms, output slew rate limiting, under voltage detection, automatic-on output, and enable pin with choice of either active low or active high enable. The FET is self-contained, with a fixed- or user-adjustable current limit. The MIC20XX family is ideal for any system where current limiting and power control are desired.

The MIC201X ($3 \leq X \leq 9$) and MIC2019A switches offer a unique new patented feature: Kickstart which allows momentary high-current surges up to the secondary current limit (I_{LIMIT_2nd}) without sacrificing overall system safety.

The MIC20XX family is offered, depending on the desired features, in a space-saving 5-lead SOT-23, 6-lead SOT-23, and 2 mm x 2 mm DFN packages.

MIC20XX

MIC20XX Family Package Types

Fixed Current Limit (MIC20X3)

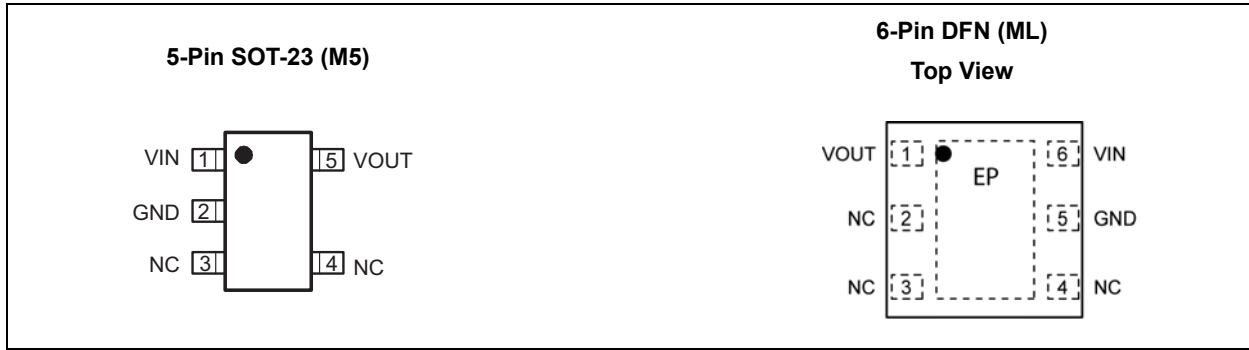

Fixed Current Limit (MIC20X4)

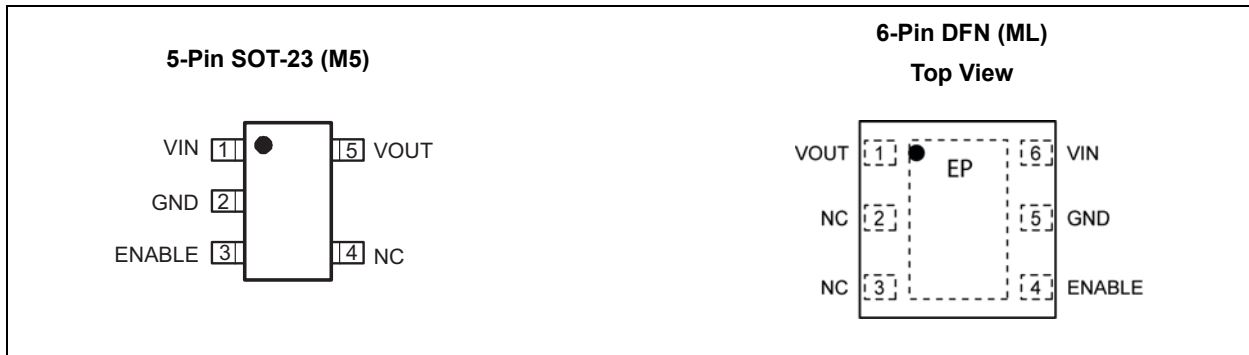

Fixed Current Limit (MIC20X5)

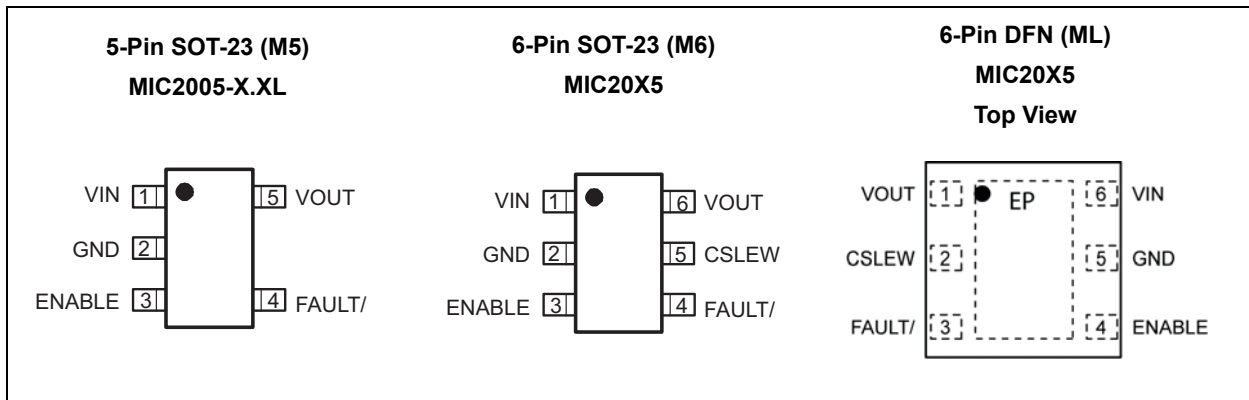

Fixed Current Limit (MIC20X6)

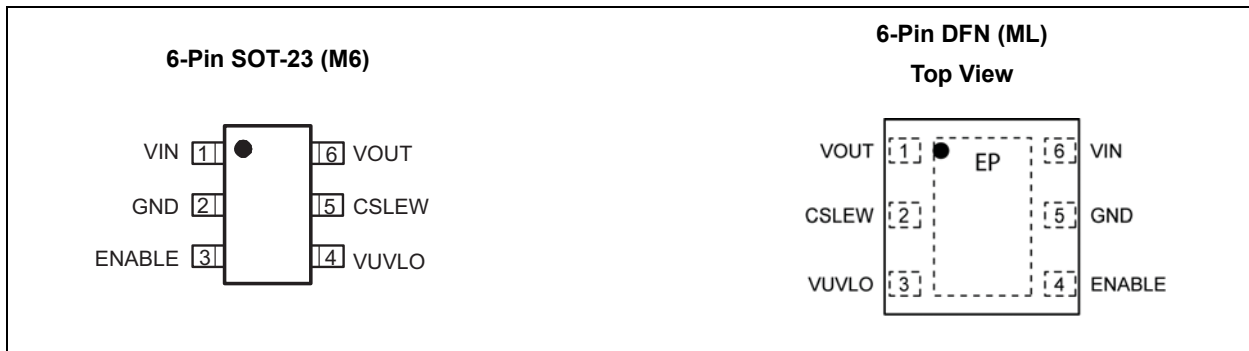

MIC20XX Family Package Types (Continued)

Adjustable Current Limit (MIC20X7/MIC20X8)



Adjustable Current Limit (MIC20X9)

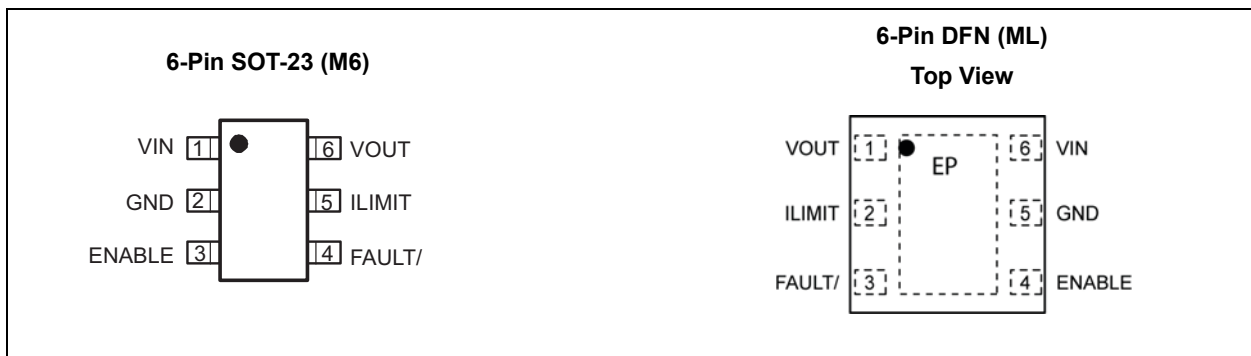

Adjustable Current Limit (MIC2005A)

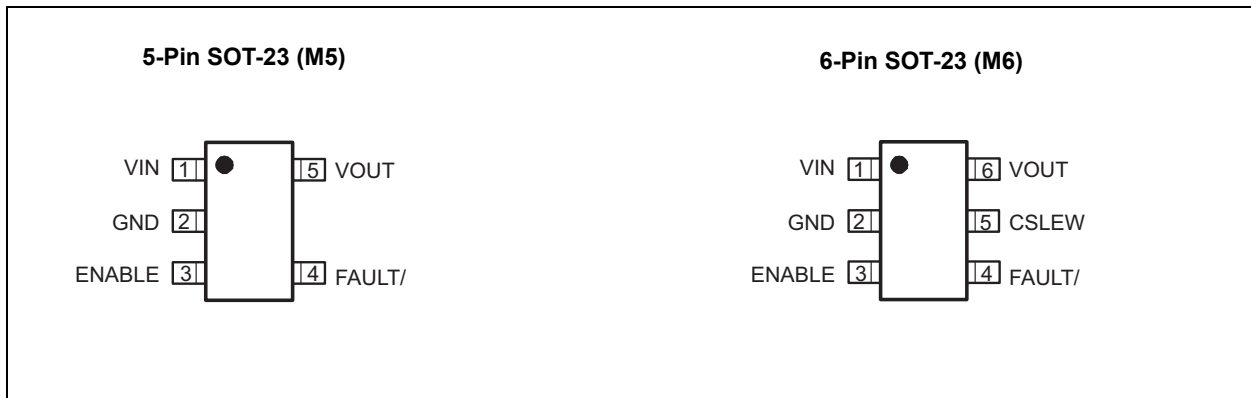

Adjustable Current Limit (MIC2009A)

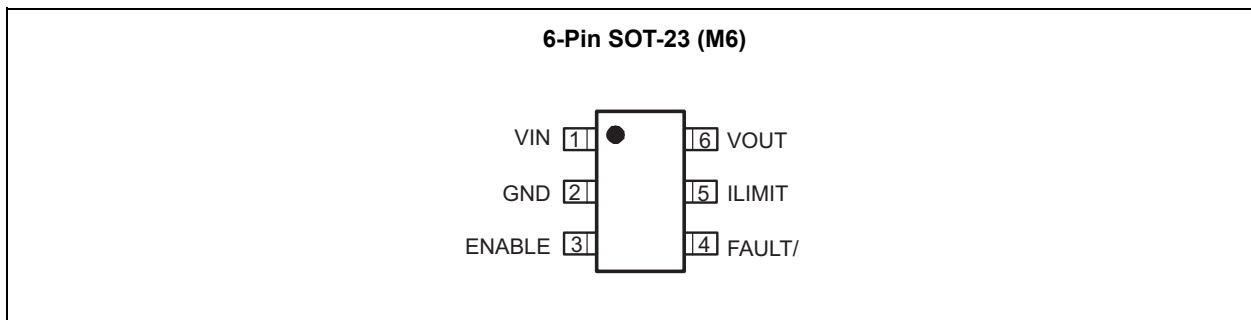

MIC20XX

Typical Application Circuit

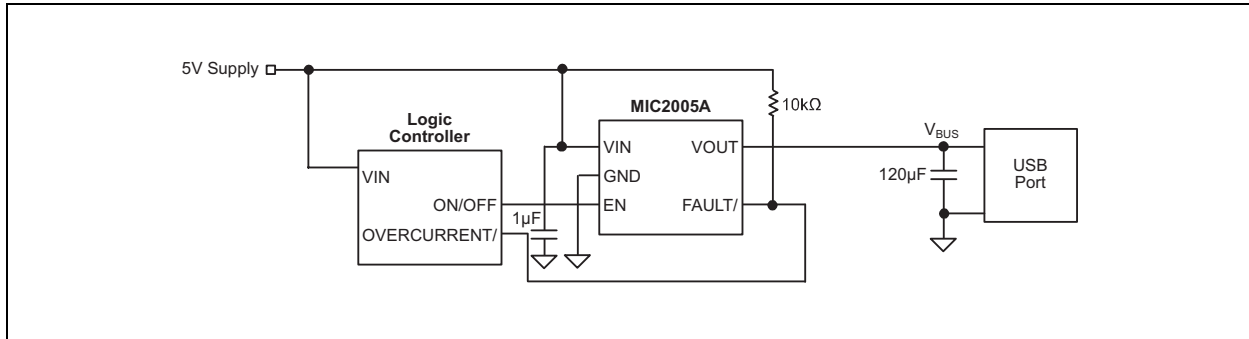

Functional Block Diagram

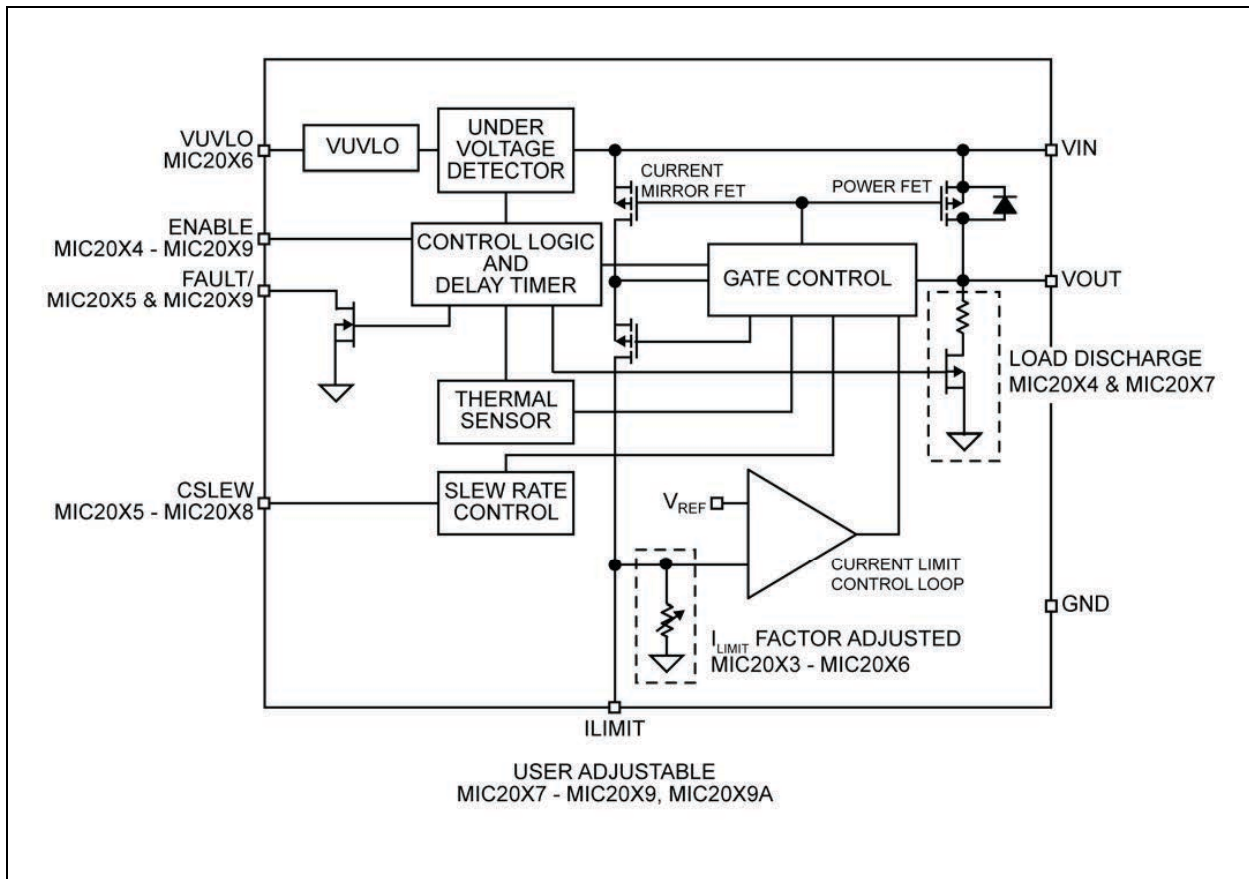

1.0 ELECTRICAL CHARACTERISTICS

Absolute Maximum Ratings †

V_{IN} , V_{OUT}	-0.3V to +6V
All Other Pins	-0.3 to +5.5V
Power Dissipation (P_D)	Internally Limited
Continuous Output Current	
All except MIC2005A/MIC20X9A	2.25A
MIC2005A/MIC20X9A	1.0A
ESD (HBM) Note 1	
V_{OUT} and GND	±4 kV
All Other Pins	±2 kV
ESD (MM) Note 1	
All Pins	±200V

Operating Ratings ††

Supply Voltage	+2.5V to +5.5V
Continuous Output Current	
All except MIC2005A/MIC20X9A	0A to 2.1A
MIC2005A/MIC20X9A	0A to 0.9A

† **Notice:** Stresses above those listed under “Absolute Maximum Ratings” may cause permanent damage to the device. This is a stress rating only and functional operation of the device at those or any other conditions above those indicated in the operational sections of this specification is not intended. Exposure to maximum rating conditions for extended periods may affect device reliability.

†† **Notice:** The device is not guaranteed to function outside its operating ratings.

Note 1: Devices are ESD sensitive. Handling precautions recommended. Human body model, 1.5 kΩ in series with 100pF.

ELECTRICAL CHARACTERISTICS

Electrical Characteristics: $V_{IN} = 5V$; $C_{IN} = 1 \mu F$; $T_A = +25^\circ C$, unless otherwise noted. **Bold** indicates specifications over the full operating temperature range of $-40^\circ C$ to $+85^\circ C$. ([Note 1](#))

Parameter	Symbol	Min.	Typ.	Max.	Units	Conditions
Switch Input Voltage	V_{IN}	2.5	—	5.5	V	—
Output Leakage Current (Note 2)	I_{LEAK}	—	12	100	μA	Switch = OFF, $V_{OUT} = 0V$ Active-Low Enable, $V_{EN} = 1.5V$ Active-High Enable, $V_{EN} = 0V$
MIC2005A, MIC2009A, MIC2019A						
Supply Current (Note 2)	I_{IN}	—	80	300	μA	Switch = ON Active-Low Enable, $V_{EN} = 0V$ Active-High Enable, $V_{EN} = 1.5V$
		—	8	15		Switch = OFF Active-Low Enable, $V_{EN} = 1.5V$
		—	1	5		Switch = OFF Active-High Enable, $V_{EN} = 0V$
Power Switch Resistance	$R_{DS(ON)}$	—	170	220	mΩ	$V_{IN} = 5V$, $I_{OUT} = 100 mA$
		—	—	275		
MIC2005A						
Fixed Current Limit	I_{LIMIT}	0.5	0.7	0.9	A	$V_{OUT} = 0.8 \times V_{IN}$

MIC20XX

ELECTRICAL CHARACTERISTICS (CONTINUED)

Electrical Characteristics: $V_{IN} = 5V$; $C_{IN} = 1 \mu F$; $T_A = +25^\circ C$, unless otherwise noted. **Bold** indicates specifications over the full operating temperature range of $-40^\circ C$ to $+85^\circ C$. (Note 1)

Parameter	Symbol	Min.	Typ.	Max.	Units	Conditions
MIC2009A, MIC2019A						
Variable Current Limit Factors	C_{LF}	172	211	263	V	$I_{OUT} = 0.9A, V_{OUT} = 0.8 \times V_{IN}$
		152	206	263		$I_{OUT} = 0.5A, V_{OUT} = 0.8 \times V_{IN}$
		138	200	263		$I_{OUT} = 0.2A, V_{OUT} = 0.8 \times V_{IN}$
		121	192	263		$I_{OUT} = 0.1A, V_{OUT} = 0.8 \times V_{IN}$
MIC2019A						
Secondary Current Limit	I_{LIMIT_2nd}	1	2	3	A	$V_{IN} = 2.5V, V_{OUT} = 0V$
MIC2003-MIC2009, MIC2013-MIC2019, MIC2005-X.XL						
Supply Current (Note 2)	I_{IN}	—	80	330	μA	Switch = ON Active-Low Enable, $V_{EN} = 0V$ Active-High Enable, $V_{EN} = 1.5V$
		—	8	15		Switch = OFF Active-Low Enable, $V_{EN} = 1.5V$
		—	1	5		Switch = OFF Active-High Enable, $V_{EN} = 0V$
Power Switch Resistance	$R_{DS(ON)}$	—	70	100	m Ω	$V_{IN} = 5V, I_{OUT} = 100 mA$
		—		125		
MIC2003-X.X, MIC2004-X.X, MIC2005-X.X, MIC2005-X.XL, MIC2006-X.X, MIC2013-X.X, MIC2014-X.X, MIC2015-X.X MIC2016-X.X						
Fixed Current Limit	I_{LIMIT}	0.5	0.7	0.9	A	$-0.5, V_{OUT} = 0.8 \times V_{IN}$
		0.8	1.1	1.5		$-0.8, V_{OUT} = 0.8 \times V_{IN}$
		1.2	1.6	2.1		$-1.2, V_{OUT} = 0.8 \times V_{IN}$
MIC2005-0.5						
Fixed Current Limit	I_{LIMIT}	0.5	0.7	0.9	A	$V_{OUT} = 0.8 \times V_{IN}$
MIC2007, MIC2008, MIC2009, MIC2017, MIC2018, MIC2019						
Variable Current Limit Factors	C_{LF}	210	250	286	V	$I_{OUT} = 2.0A, V_{OUT} = 0.8 \times V_{IN}$
		190	243	293		$I_{OUT} = 1.0A, V_{OUT} = 0.8 \times V_{IN}$
		168	235	298		$I_{OUT} = 0.5A, V_{OUT} = 0.8 \times V_{IN}$
		144	225	299		$I_{OUT} = 0.2A, V_{OUT} = 0.8 \times V_{IN}$
MIC2013, MIC2014, MIC2015, MIC2016, MIC2017, MIC2018, MIC2019						
Secondary Current Limit	I_{LIMIT_2nd}	2.2	4	6	A	$V_{IN} = 2.5V, V_{OUT} = 0V$
MIC2006, MIC2016						
Variable UVLO Threshold	V_{UVLO_TH}	225	250	275	mV	—
MIC20x4, MIC20x7						
Load Discharge Resistance	R_{DSCHG}	70	126	200	Ω	$V_{IN} = 5V, I_{SINK} = 5 mA$
MIC20X5, MIC20X6, MIC20X7, MIC20X8						
C_{SLEW} Input Current	I_{CSLEW}	—	0.175	—	μA	$0V \leq V_{OUT} \leq 0.8 V_{IN}$

ELECTRICAL CHARACTERISTICS (CONTINUED)

Electrical Characteristics: $V_{IN} = 5V$; $C_{IN} = 1 \mu F$; $T_A = +25^\circ C$, unless otherwise noted. **Bold** indicates specifications over the full operating temperature range of $-40^\circ C$ to $+85^\circ C$. (Note 1)

Parameter	Symbol	Min.	Typ.	Max.	Units	Conditions
All Parts						
Enable Input Voltage (Note 3)	V_{EN}	—	—	0.5	V	V_{IL} (MAX)
		1.5	—	—		V_{IH} (MIN)
Enable Input Current	I_{EN}	—	1	5	μA	$0V \leq V_{EN} \leq 5V$
Undervoltage Lock-Out Threshold	UVLO_TH	2	2.25	2.5	V	V_{IN} Rising
		1.9	2.15	2.4		V_{IN} Falling
Undervoltage Lock-Out Hysteresis	UVLO_HYS	—	0.1	—	V	—
Fault Status Output Voltage	V_{FAULT}	—	0.25	0.4	V	$I_{OL} = 10 \text{ mA}$
Overtemperature Threshold	OT_TH	—	145	—	$^\circ C$	T_J Increasing
		—	135	—		T_J Decreasing

Note 1: Specification for packaged product only.

2: Check the Ordering Information section to determine which parts are Active-High or Active-Low.

3: V_{IL} (MAX) = Maximum positive voltage applied to the input which will be accepted by the device as a logic low. V_{IH} (MAX) = Maximum positive voltage applied to the input which will be accepted by the device as a logic high.

MIC20XX

AC ELECTRICAL CHARACTERISTICS

Parameters	Symbol	Min.	Typ.	Max.	Units	Conditions
Output Turn-On Rise Time	t_{RISE}	500	1000	1500	μs	$R_L = 10\Omega$, $C_{LOAD} = 1\ \mu F$, $V_{OUT} = 10\%$ to 90% $C_{SLEW} = \text{Open}$ (Note 1)
Delay before asserting or releasing FAULT/ MIC2003 - MIC2009 MIC2009A, MIC2005A	t_{D_FAULT}	20	32	49	ms	Time from current limiting to FAULT/ state change
Delay before asserting or releasing FAULT/ MIC2013 - MIC2019 MIC2019A		77	128	192		Time from I_{OUT} continuously exceeding primary current limit condition to FAULT/ state change
Delay before current limiting MIC2013 - MIC2019 MIC2019A	t_{D_LIMIT}	77	128	192	ms	—
Delay before resetting Kickstart current limit delay, t_{D_LIMIT} MIC2013 - MIC2019 MIC2019A	t_{RESET}	77	128	192	ms	Out of current limit following a current limit event.
Output Turn-On Delay	t_{ON_DLY}	—	1000	1500	μs	$R_L = 43\Omega$, $C_L = 120\ \mu F$, $V_{EN} = 50\%$ to $V_{OUT} = 10\%$ * $C_{SLEW} = \text{Open}$
Output Turn-Off Delay	t_{OFF_DLY}	—	—	700	μs	$R_L = 43\Omega$, $C_L = 120\ \mu F$, $V_{EN} = 50\%$ to $V_{OUT} = 90\%$ * $C_{SLEW} = \text{Open}$

Note 1: Whenever C_{SLEW} is present.

TEMPERATURE SPECIFICATIONS (Note 1)

Parameters	Symbol	Min.	Typ.	Max.	Units	Conditions
Temperature Ranges						
Maximum Junction Temperature	T_J	—	—	+150	$^{\circ}C$	—
Storage Temperature	T_S	-65	—	+150	$^{\circ}C$	—
Ambient Temperature Range	T_A	-40	—	+85	$^{\circ}C$	—
Lead Temperature	—	—	—	+260	$^{\circ}C$	Soldering, 10 sec.
Package Thermal Resistances (Note 2)						
Thermal Resistance, SOT-23-5/6	θ_{JA}	—	230	—	$^{\circ}C/W$	—
Thermal Resistance, 6-Lead DFN	θ_{JA}		90			
	θ_{JC}		45			

Note 1: The maximum allowable power dissipation is a function of ambient temperature, the maximum allowable junction temperature and the thermal resistance from junction to air (i.e., T_A , T_J , θ_{JA}). Exceeding the maximum allowable power dissipation will cause the device operating junction temperature to exceed the maximum +150 $^{\circ}C$ rating. Sustained junction temperatures above +150 $^{\circ}C$ can impact the device reliability.

2: Requires proper thermal mounting to achieve this performance.

Timing Diagrams

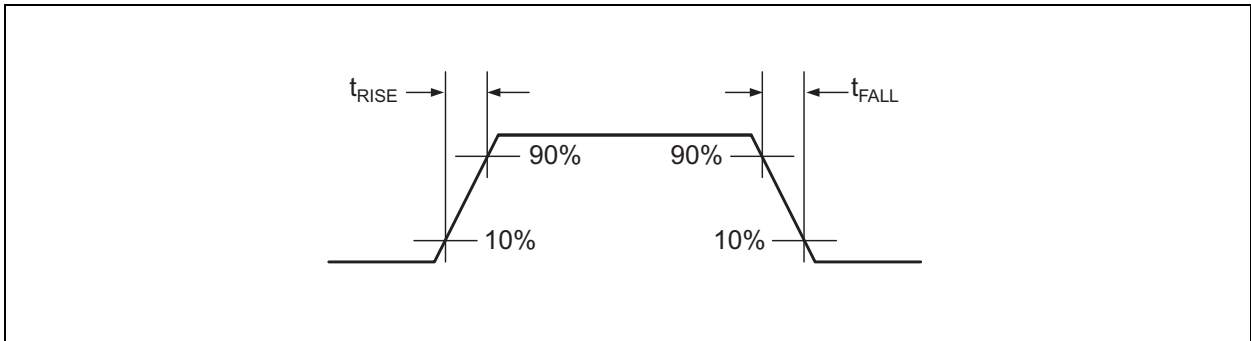

FIGURE 1-1: Rise and Fall Times.

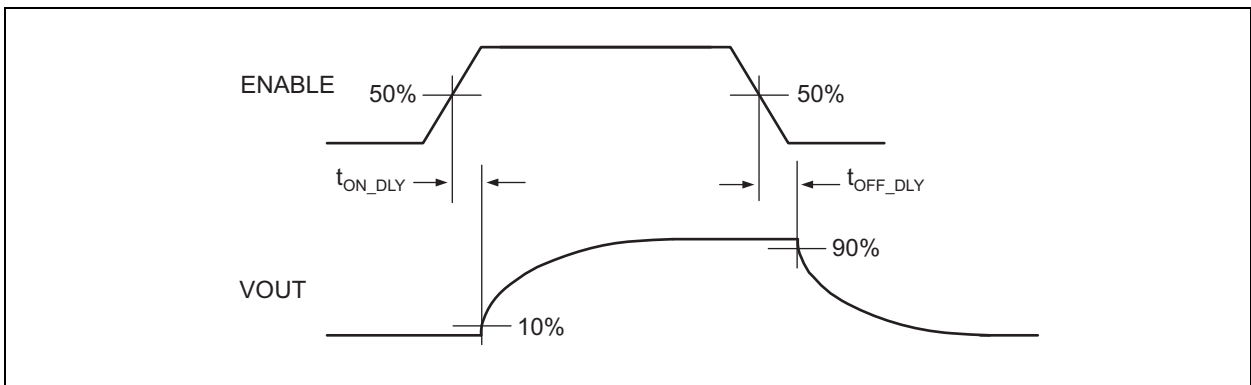

FIGURE 1-2: Switching Delay Times.

MIC20XX

2.0 TYPICAL PERFORMANCE CURVES

Note: The graphs and tables provided following this note are a statistical summary based on a limited number of samples and are provided for informational purposes only. The performance characteristics listed herein are not tested or guaranteed. In some graphs or tables, the data presented may be outside the specified operating range (e.g., outside specified power supply range) and therefore outside the warranted range.

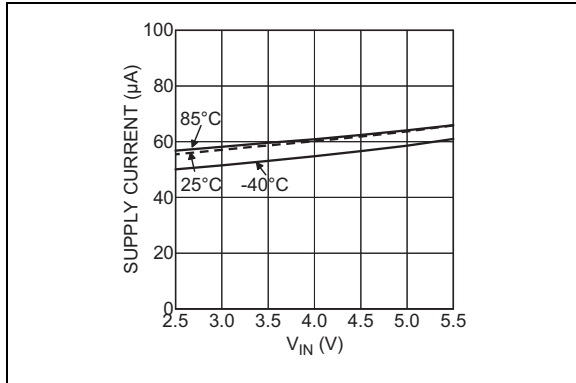

FIGURE 2-1: Supply Current Output Enabled (MIC20XX).

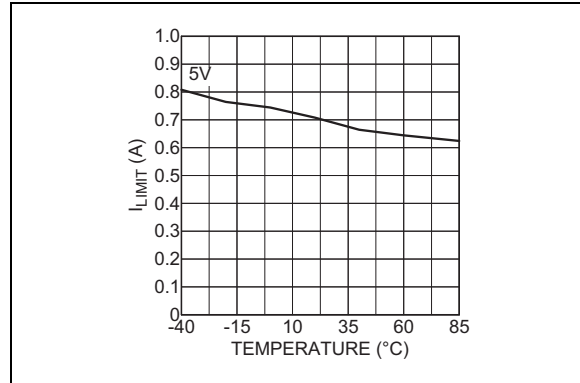

FIGURE 2-4: I_{LIMIT} vs. Temperature (MIC20XX-0.5).

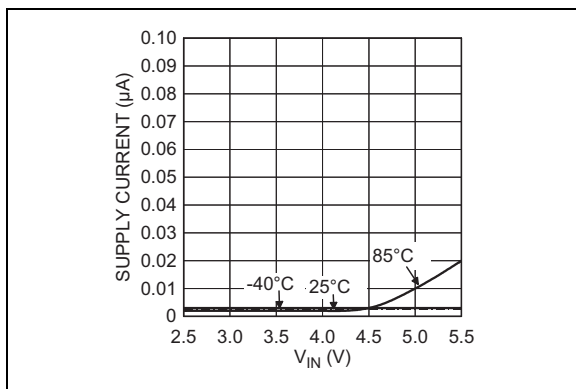

FIGURE 2-2: Supply Current Output Disabled (MIC20XX).

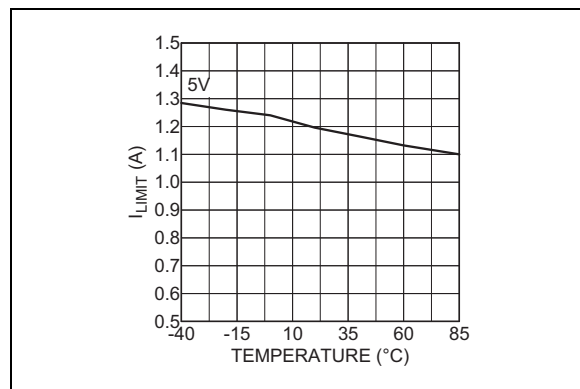

FIGURE 2-5: I_{LIMIT} vs. Temperature (MIC20XX-0.8).

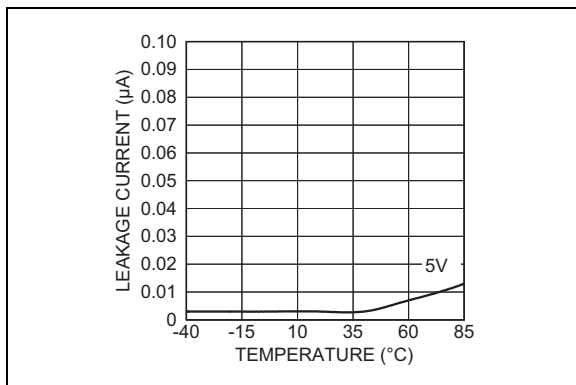

FIGURE 2-3: Switch Leakage Current (MIC20XX).

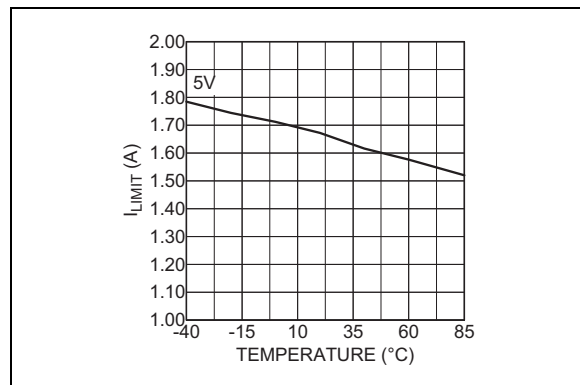

FIGURE 2-6: I_{LIMIT} vs. Temperature (MIC20XX-1.2).

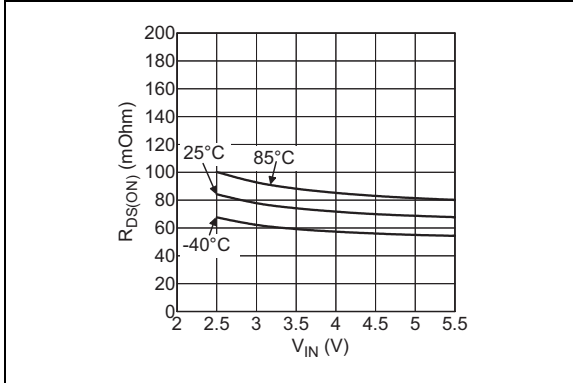

FIGURE 2-7: $R_{DS(ON)}$ vs. V_{IN} (MIC20XX).

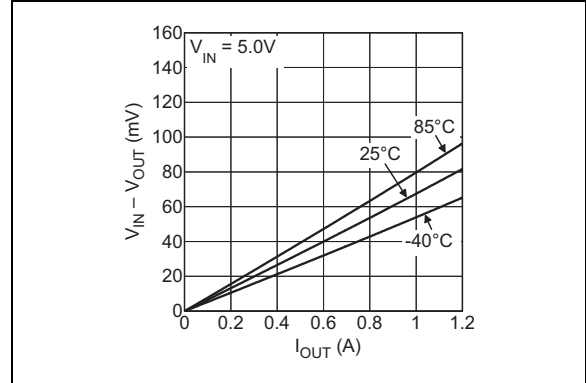

FIGURE 2-10: V_{DROP} vs. Temperature (MIC20XX-1.2).

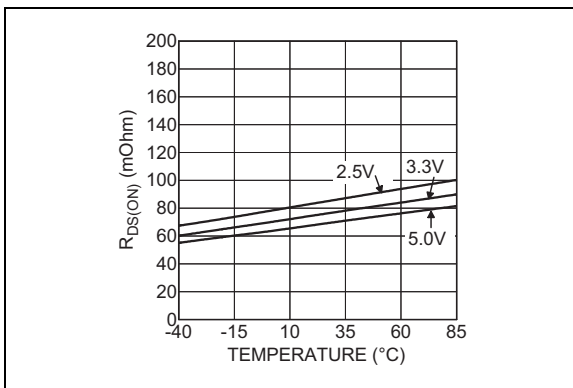

FIGURE 2-8: $R_{DS(ON)}$ vs. Temperature (MIC20XX).

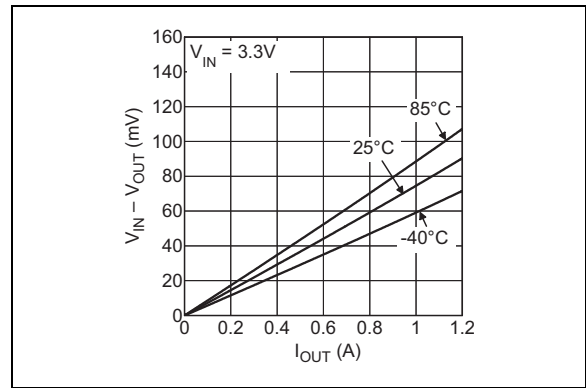

FIGURE 2-11: V_{DROP} vs. Temperature (MIC20XX-1.2).

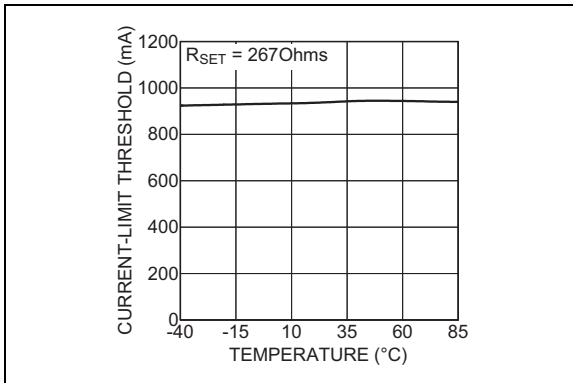

FIGURE 2-9: I_{LIMIT} vs. Temperature (MIC20X9-0.9A).

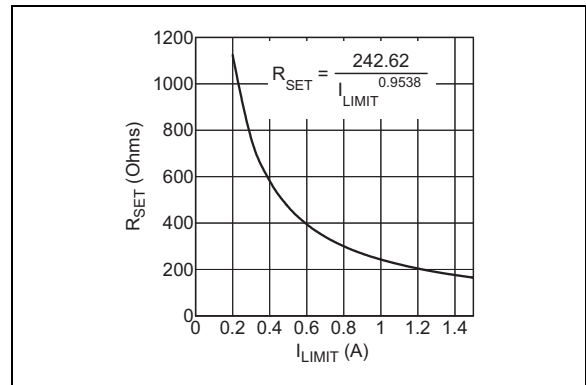

FIGURE 2-12: R_{SET} vs. I_{LIMIT} (MIC20X9).

MIC20XX

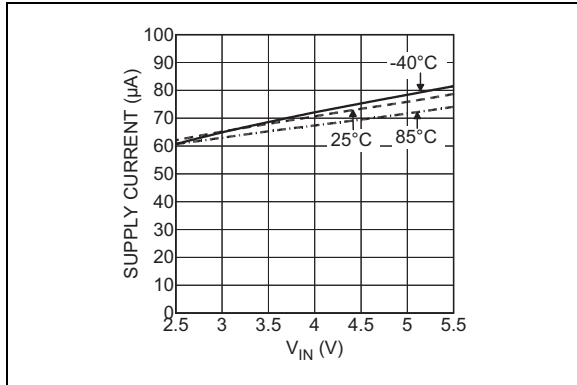

FIGURE 2-13: Supply Current Output Enabled (MIC20XXA).

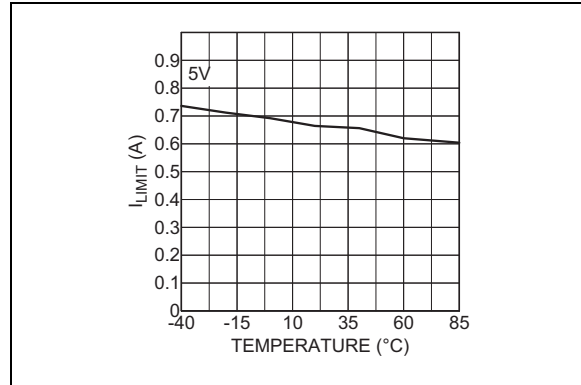

FIGURE 2-16: I_{LIMIT} vs. Temperature (MIC20X5A).

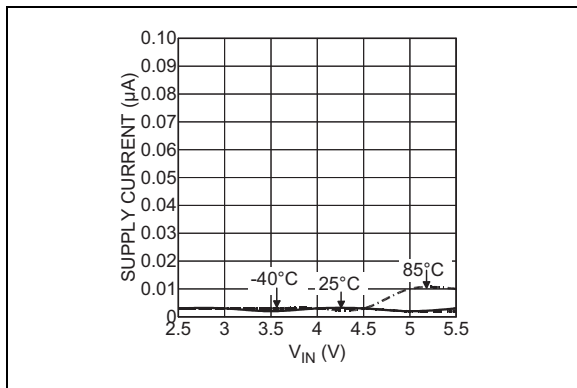

FIGURE 2-14: Supply Current Output Disabled (MIC20XXA).

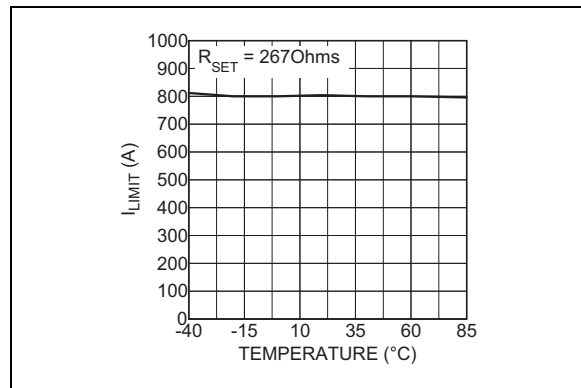

FIGURE 2-17: I_{LIMIT} vs. Temperature (MIC20X9A-0.8A).

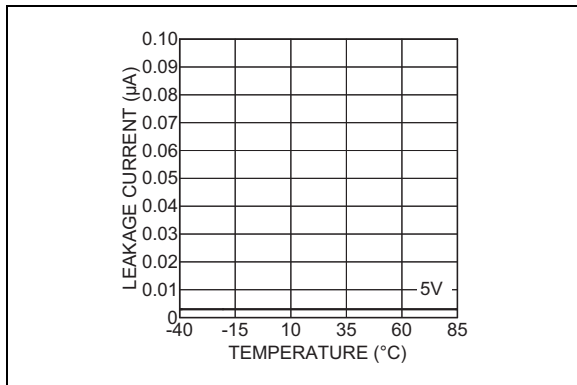

FIGURE 2-15: Switch Leakage Current (MIC20XXA).

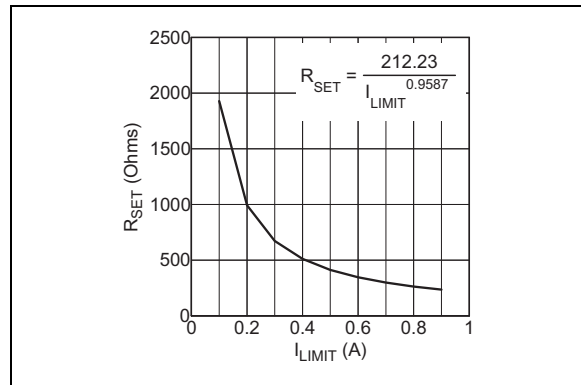

FIGURE 2-18: R_{SET} vs I_{LIMIT} (MIC20X9A).

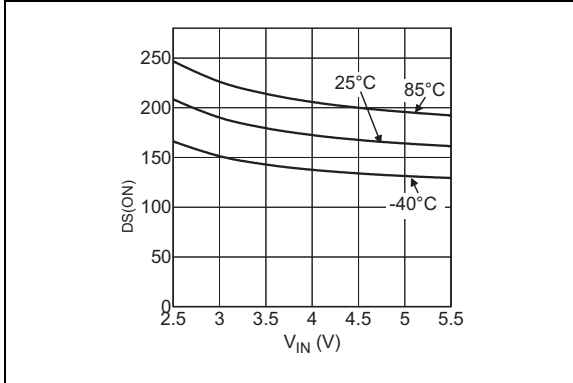

FIGURE 2-19: $R_{DS(ON)}$ vs. V_{IN} (MIC20XXA).

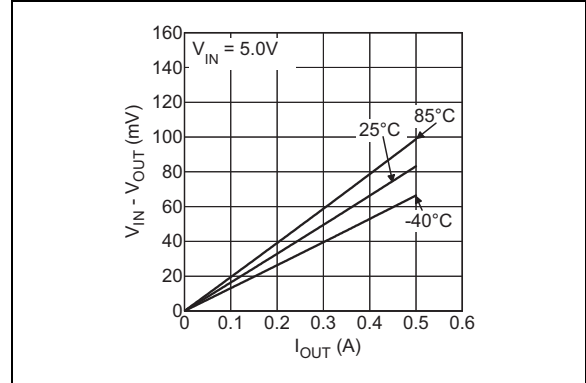

FIGURE 2-22: V_{DROP} vs. Temperature (MIC20XXA).

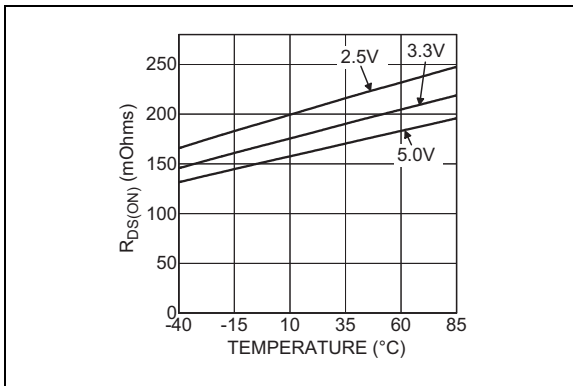

FIGURE 2-20: $R_{DS(ON)}$ vs. Temperature (MIC20XXA).

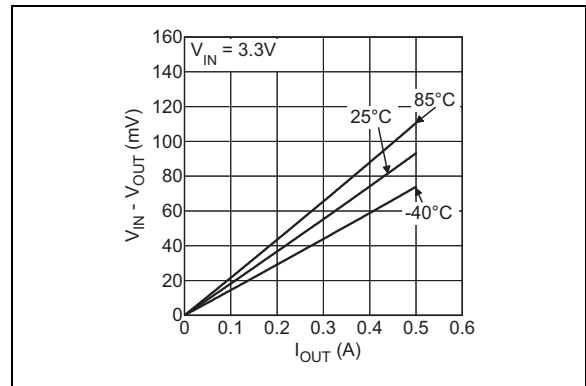

FIGURE 2-23: V_{DROP} vs. Temperature (MIC20XXA).

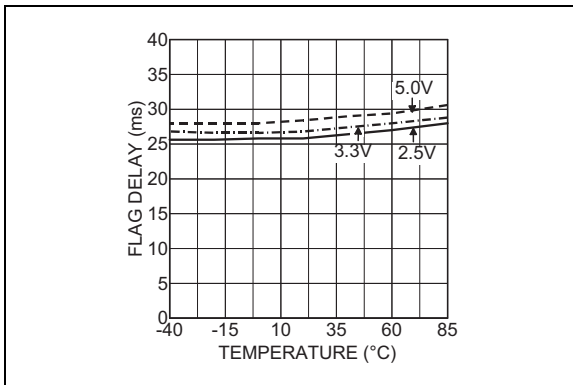

FIGURE 2-21: Flag Delay vs. Temperature.

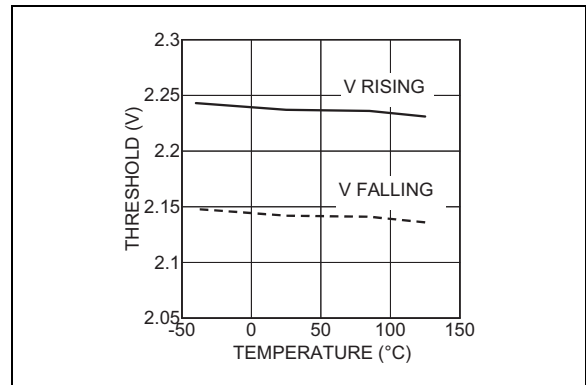

FIGURE 2-24: UVLO Threshold vs. Temperature.

MIC20XX

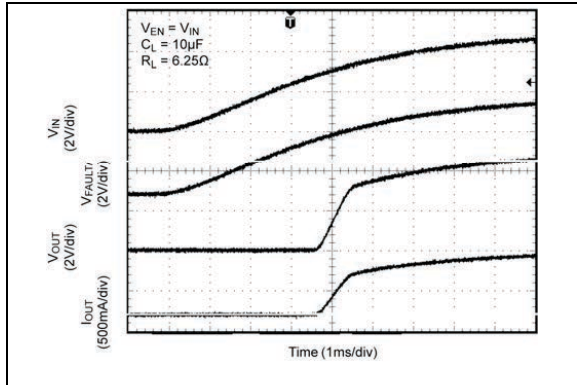

FIGURE 2-25: V_{IN} Soft Turn-On.

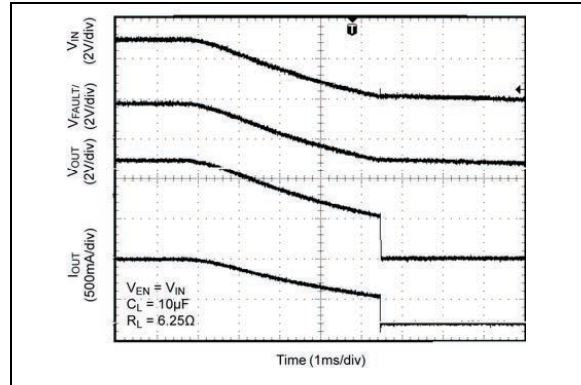

FIGURE 2-28: Turn-Off V_{IN} .

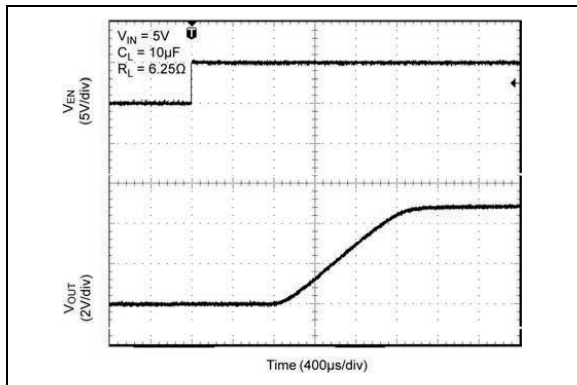

FIGURE 2-26: Enable Turn-On Delay and Rise Time.

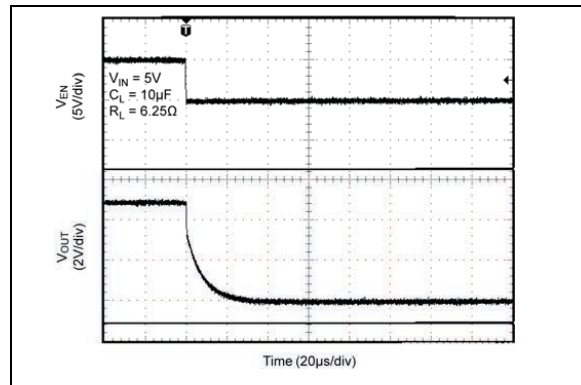

FIGURE 2-29: Enable Turn-Off Delay and Fall Time.

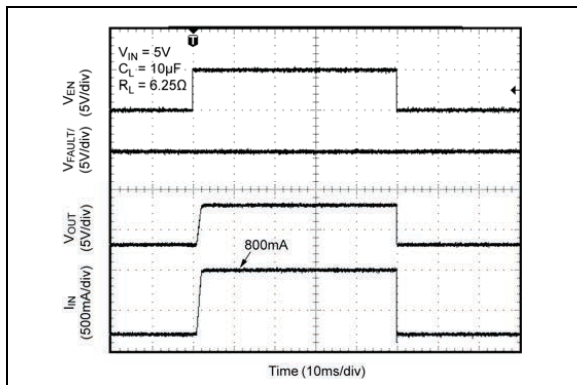

FIGURE 2-27: Enable Turn-On/Turn-Off.

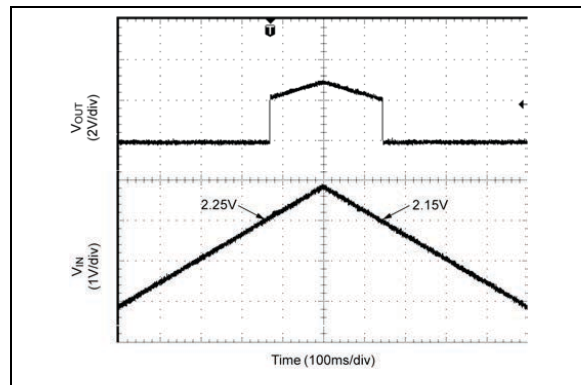

FIGURE 2-30: UVLO.

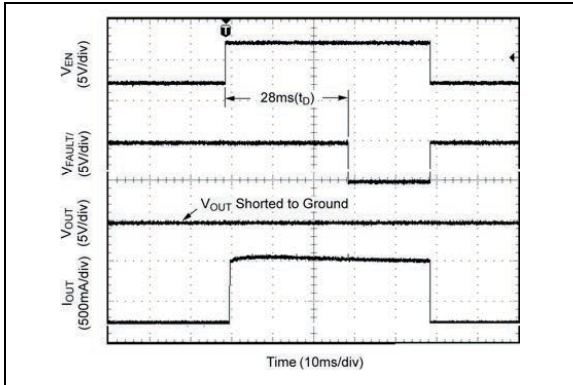

FIGURE 2-31: Enabled Into Short.

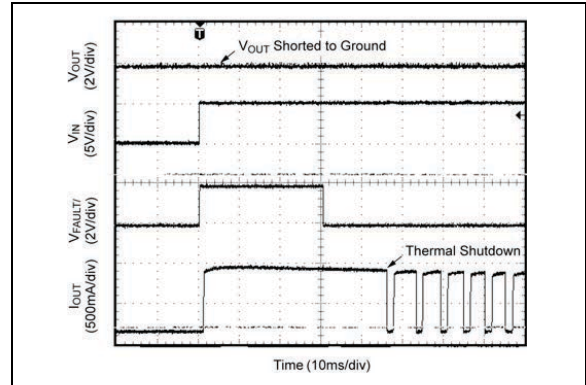

FIGURE 2-34: Power Up Into Short Circuit.

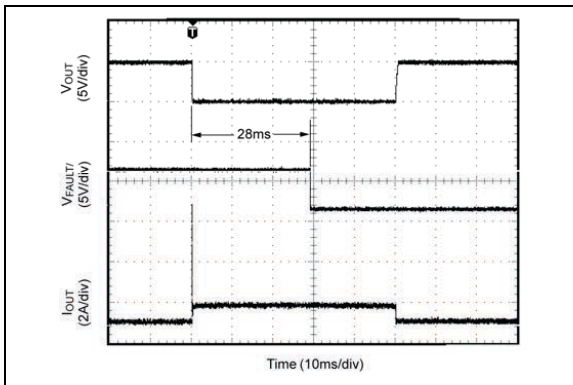

FIGURE 2-32: Current Limit Response, Stepped Short.

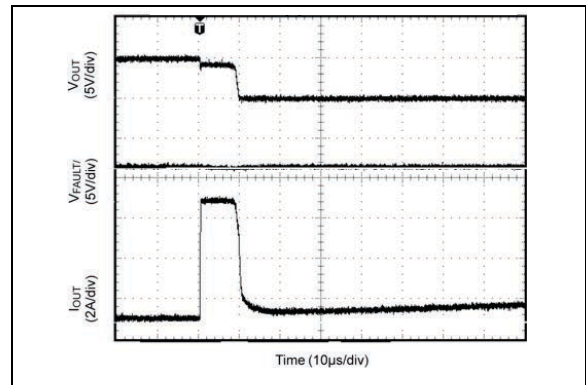

FIGURE 2-35: Current Limit Response Time, Stepped Short.

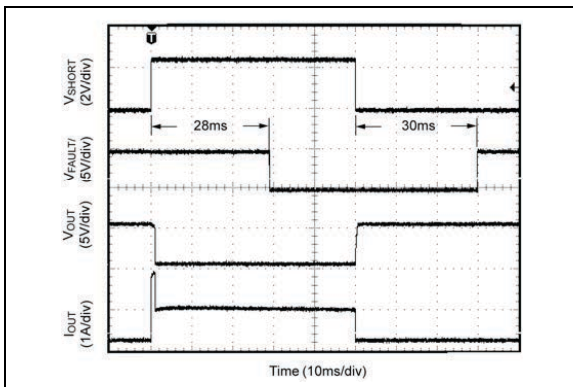

FIGURE 2-33: Output Recovery From Short Circuit.

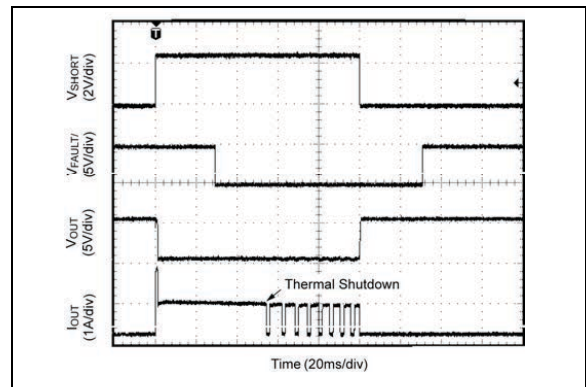

FIGURE 2-36: Output Recovery From Thermal Shutdown.

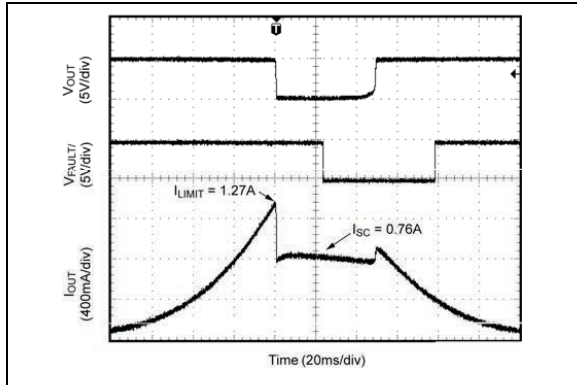

FIGURE 2-37: Current-Limit Threshold.

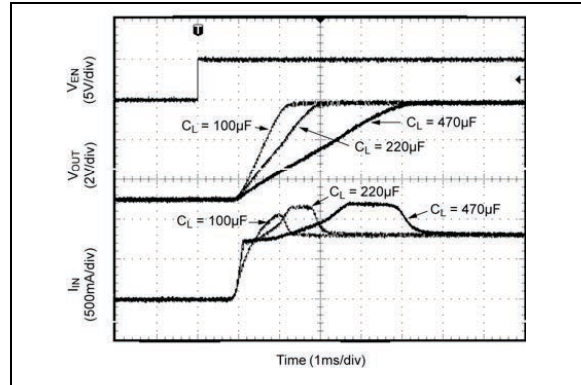

FIGURE 2-40: Current Inrush Current Response.

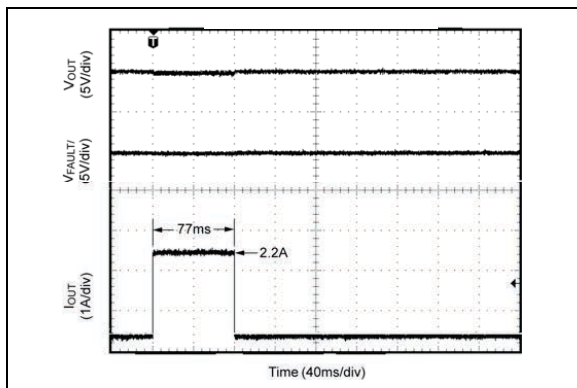

FIGURE 2-38: Kickstart Response 77 ms/2.2A Load Step.

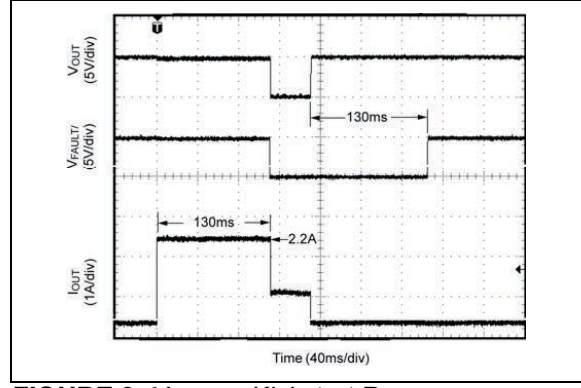

FIGURE 2-41: Kickstart Response 150 ms/2.2A Load Step

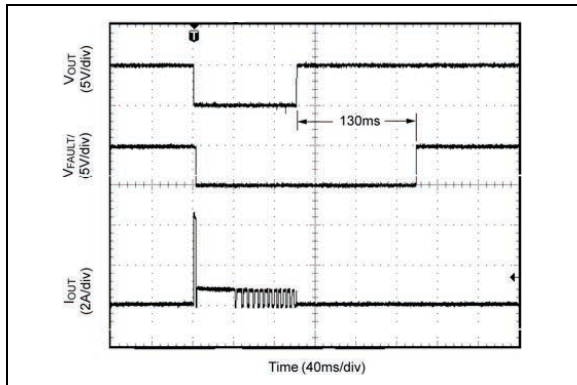

FIGURE 2-39: Kickstart Response Recovery From Thermal Shutdown.

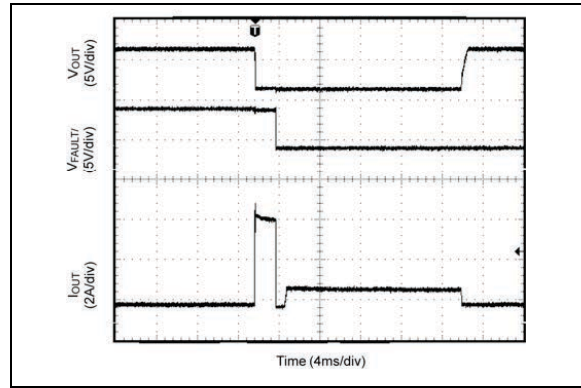

FIGURE 2-42: Kickstart Response Time 5A Over Load.

3.0 PIN DESCRIPTIONS

These pin and signal descriptions aid in the differentiation of a pin from electrical signals and components connected to that pin. For example, VOUT is the switch's output pin, while V_{OUT} is the electrical signal output voltage present at the VOUT pin. The descriptions of the pins are listed in [Table 3-1](#).

TABLE 3-1: PIN FUNCTION TABLE

Pin Name	Type	Description
VIN	Input	Supply input. This pin provides power to both the output switch and the switch's internal control circuitry.
GND	—	Ground
EN	Input	Switch Enable (Input):
FAULT/	Output	Fault status. A logic low on this pin indicates the switch is in current limiting, or has been shut down by the thermal protection circuit. This is an open-drain output allowing logical OR'ing of multiple switches.
CSLEW	Input	Slew rate control. Adding a small value capacitor between this pin and VIN slows turn-on of the power FET.
VOUT	Output	Switch output. The load being driven by the switch is connected to this pin.
VUVLO	Input	Variable Under Voltage Lockout (VUVLO): Monitors the input voltage through a resistor divider between VIN and GND. Shuts the switch off if voltage falls below the threshold set by the resistor divider. Previously called VUVLO.
ILIMIT	Input	Set current limit threshold via a resistor connected from ILIMIT to GND.
EP	Thermal	On DFN packages connect EP to GND.

TABLE 3-2: SIGNAL DESCRIPTION TABLE

Signal Name	Type	Description
V_{IN}	Input	Electrical signal input voltage present at the VIN pin.
GND	—	Ground
V_{EN}	Input	Electrical signal input voltage present at the ENABLE pin.
$V_{FAULT/}$	Output	Electrical signal output voltage present at the FAULT/ pin.
C_{SLEW}	Component	Capacitance value connected to the CSLEW pin.
V_{OUT}	Output	Electrical signal output voltage present at the VOUT pin.
V_{VUVLO_TH}	Internal	VUVLO internal reference threshold voltage. This voltage is compared to the VUVLO pin input voltage to determine if the switch should be disabled. Reference threshold voltage has a typical value of 250 mV.
C_{LOAD}	Component	Capacitance value connected in parallel with the load. Load capacitance.
I_{OUT}	Output	Electrical signal output current present at the VOUT pin.
I_{LIMIT}	Internal	Switch's current limit. Fixed at factory or user adjustable.

MIC20XX

4.0 FUNCTIONAL DESCRIPTION

4.1 V_{IN} and V_{OUT}

V_{IN} is both the power supply connection for the internal circuitry driving the switch and the input (Source connection) of the power MOSFET switch. V_{OUT} is the Drain connection of the power MOSFET and supplies power to the load. In a typical circuit, current flows from V_{IN} to V_{OUT} toward the load. Because the switch is bi-directional when enabled, if V_{OUT} is greater than V_{IN} , current will flow from V_{OUT} to V_{IN} .

When the switch is disabled, current will not flow to the load, except for a small unavoidable leakage current of a few microamps. However, should V_{OUT} exceed V_{IN} by more than a diode drop ($\sim 0.6V$), while the switch is disabled, current will flow from output to input via the power MOSFET's body diode.

If discharging C_{LOAD} is required by your application, consider using MIC20X4 or MIC20X7; these MIC20XX family members are equipped with a discharge FET to be ensured complete discharge of C_{LOAD} .

4.2 Current Sensing and Limiting

MIC20XX protects the system power supply and load from damage by continuously monitoring current through the on-chip power MOSFET. Load current is monitored by means of a current mirror in parallel with the power MOSFET switch. Current limiting is invoked when the load exceeds the set over current threshold. When current limiting is activated the output current is constrained to the limit value, and remains at this level until either the load/fault is removed, the load's current requirement drops below the limiting value, or the switch goes into thermal shutdown.

4.3 Kickstart

TABLE 4-1: KICKSTART

2003	2004	2005X	2006	2007	2008	2009X
2013	2014	2015	2016	2017	2018	2019X

Note: Only parts in bold have Kickstart (Not available in 5-lead SOT-23 packages).

The MIC201X is designed to allow momentary current surges (Kickstart) before the onset of current limiting, which permits dynamic loads, such as small disk drives or portable printers to draw the energy needed to overcome inertial loads without sacrificing system safety. In this respect, the Kickstart parts (MIC201X) differs markedly from the non-Kickstart parts (MIC200X) which immediately limit load current, potentially starving the motor and causing the appliance to stall or stutter.

During this delay period, typically 128 ms, a secondary current limit is in effect. If the load demands a current in excess the secondary limit, MIC201X acts immediately

to restrict output current to the secondary limit for the duration of the Kickstart period. After this time the MIC201X reverts to its normal current limit. An example of Kickstart operation is shown in Figure 4-1:

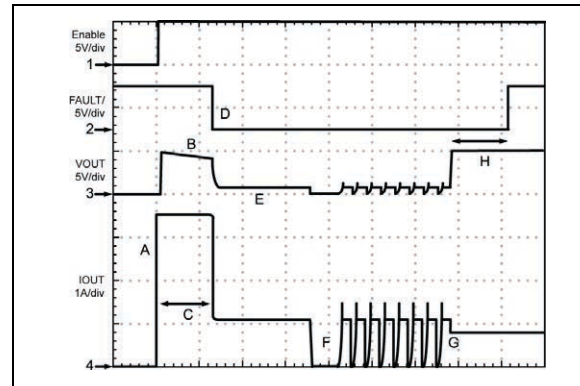

FIGURE 4-1: Kickstart Operation.

Figure 4-1 Label Key:

- A. MIC201X is enabled into an excessive load (slew rate limiting not visible at this time scale). The initial current surge is limited by either the overall circuit resistance and power supply compliance, or the secondary current limit, whichever is less.
- B. R_{ON} of the power FET increases due to internal heating (effect exaggerated for emphasis).
- C. Kickstart period.
- D. Current limiting initiated. FAULT/ goes LOW.
- E. V_{OUT} is non-zero (load is heavy, but not a dead short where $V_{OUT} = 0V$). Limiting response will be the same for dead shorts).
- F. Thermal shutdown followed by thermal cycling.
- G. Excessive load released, normal load remains. MIC201X drops out of current limiting.
- H. FAULT/ delay period followed by FAULT/ going HIGH.

4.4 Undervoltage Lockout

Undervoltage lockout ensures no anomalous operation occurs before the device's minimum input voltage of $UVLO_{THRESHOLD}$, which is 2V minimum, 2.25V typical, and 2.5V maximum, has been achieved. Prior to reaching this voltage, the output switch (power MOSFET) is OFF and no circuit functions, such as FAULT/ or ENABLE, are considered to be valid or operative.

4.5 Variable Undervoltage Lockout

TABLE 4-2: VARIABLE UNDERVOLTAGE LOCKOUT (VUVLO)

2003	2004	2005X	2006	2007	2008	2009X
2013	2014	2015	2016	2017	2018	2019X

Note: Only parts in **bold** have UVLO.

V_{UVLO} functions as an input voltage monitor when the switch is enabled. The V_{IN} pin is monitored for a drop in voltage, indicating excessive loading of the V_{IN} supply. When V_{IN} is less than the V_{ULVO} threshold voltage (V_{VUVLO_TH}) for 32 ms or more, the MIC20XX disables the switch to protect the supply and allow V_{IN} to recover. After 128 ms has elapsed, the MIC20X6 enables switch. This disable and enable cycling will continue as long as V_{IN} decreases below the V_{UVLO} threshold voltage (V_{VUVLO_TH}) which has a typical value of 250 mV. The V_{UVLO} voltage is commonly established by a voltage divider from V_{IN} -to-GND.

4.6 Enable

TABLE 4-3: ENABLE

2003	2004	2005X	2006	2007	2008	2009X
2013	2014	2015	2016	2017	2018	2019X

Note: Only parts in **bold** have ENABLE pin.

ENABLE pin is a logic compatible input that activates the main MOSFET switch thereby providing power to the VOUT pin. ENABLE is either an active HIGH or active LOW control signal. The MIC20XX can operate with logic running from supply voltages as low as 1.5 V.

ENABLE may be driven higher than V_{IN} , but no higher than 5.5V and not less than -0.3V.

4.7 Fault/

TABLE 4-4: FAULT/

2003	2004	2005X	2006	2007	2008	2009X
2013	2014	2015	2016	2017	2018	2019X

Note: Only parts in **bold** have FAULT/ pin.

FAULT/ is an N-channel open-drain output that is asserted (LOW true) when switch either begins current limiting or enters thermal shutdown.

FAULT/ asserts after a brief delay when events occur that may be considered possible faults. This delay insures that FAULT/ is asserted only upon valid, enduring, over-current conditions and that transitory event error reports are filtered out.

In MIC200X FAULT/ asserts after a brief delay period, of 32 ms typical. After a fault clears, FAULT/ remains asserted for the delay period of 32 ms.

MIC201X's FAULT/ asserts at the end of the Kickstart period which is 128 ms typical. This masks initial current surges, such as would be seen by a motor load starting up. If the load current remains above the

current limit threshold after the Kickstart has timed out, then the FAULT/ will be asserted. After a fault clears, FAULT/ remains asserted for the delay of 128 ms.

Because FAULT/ is an open-drain it must be pulled HIGH with an external resistor and it may be wire-OR'd with other similar outputs, sharing a single pull-up resistor. FAULT/ may be tied to a pull-up voltage source which is higher than V_{IN} , but no greater than 5.5V.

4.8 Soft-Start Control

Large capacitive loads can create significant inrush current surges when charged through the switch. For this reason, the MIC20XX family of switches provides a built-in soft-start control to limit the initial inrush currents.

Soft-start is accomplished by controlling the power MOSFET when the ENABLE pin enables the switch.

4.9 C_{SLEW}

TABLE 4-5: C_{SLEW}

2003	2004	2005X	2006	2007	2008	2009X
2013	2014	2015	2016	2017	2018	2019X

Note: Only parts in **bold** have CSLEW pin. (Not available in 5-pin SOT-23 packages).

The CSLEW pin is provided to increase control of the output voltage ramp at turn-on. This input allows designers the option of decreasing the output's slew rate (slowing the voltage rise) by adding an external capacitance between the CSLEW and VIN pins.

4.10 Thermal Shutdown

Thermal shutdown is employed to protect the MIC20XX family of switches from damage should the die temperature exceed safe operating levels. Thermal shutdown shuts off the output MOSFET and asserts the FAULT/ output if the die temperature reaches 145°C.

The switch will automatically resume operation when the die temperature cools down to 135°C. If resumed operation results in reheating of the die, another shutdown cycle will occur and the switch will continue cycling between ON and OFF states until the overcurrent condition has been resolved.

Depending on PCB layout, package type, ambient temperature, etc., hundreds of milliseconds may elapse from the incidence of a fault to the output MOSFET being shut off. This delay is due to thermal time constants within the system itself. In no event will the device be damaged due to thermal overload because die temperature is monitored continuously by on-chip circuitry.

MIC20XX

5.0 APPLICATION INFORMATION

5.1 Setting I_{LIMIT}

The MIC2009/2019's current limit is user programmable and controlled by a resistor connected between the ILIMIT pin and GND. The value of this resistor is determined by [Equation 5-1](#):

EQUATION 5-1:

$$I_{LIMIT} = \frac{CurrentLimitFactor(CLF)}{R_{SET}}$$

or

EQUATION 5-2:

$$R_{SET} = \frac{CurrentLimitFactor(CLF)}{I_{LIMIT(A)}}$$

For example: Set $I_{LIMIT} = 1.25A$

Please see the [Electrical Characteristics](#) table to find CLF at $I_{LIMIT} = 1A$.

TABLE 5-1: CLF AT $I_{LIMIT} = 1A$

Min	Typ.	Max	Units
190	243	293	V

For the sake of this example, we will say the typical value of CLF at an I_{OUT} of 1A is 243V. Applying [Equation 5-2](#):

EQUATION 5-3:

$$R_{SET(\Omega)} = \frac{243V}{1.25A} = 194.4\Omega$$

Where:
 $R_{SET} = 196\Omega$ (the closest standard 1% value)

Designers should be aware that variations in the measured I_{LIMIT} for a given R_{SET} resistor, will occur because of small differences between individual ICs (inherent in silicon processing) resulting in a spread of I_{LIMIT} values. In the example above we used the typical value of CLF to calculate R_{SET} . We can determine I_{LIMIT} 's spread by using the minimum and maximum values of CLF and the calculated value of R_{SET} .

EQUATION 5-4:

$$I_{LIMIT(MIN)} = \frac{190V}{196\Omega} = 0.97A$$

$$I_{LIMIT(MAX)} = \frac{293V}{196\Omega} = 1.5A$$

Giving us a maximum I_{LIMIT} variation over temperature of:

- $I_{LIMIT_MIN} = 0.97A$ (-22%)
- $I_{LIMIT_TYP} = 1.25A$
- $I_{LIMIT_MAX} = 1.5A$ (+20%)

TABLE 5-2: MIC20X9A R_{SET} TABLE

I_{OUT}	R_{SET}	I_{LIMIT_MIN}	I_{LIMIT_MAX}
0.1A	1928 Ω	0.063A	0.136A
0.2A	993 Ω	0.137A	0.265A
0.3A	673 Ω	0.216A	0.391A
0.4A	511 Ω	0.296A	0.515A
0.5A	413 Ω	0.379A	0.637A
0.6A	346 Ω	0.463A	0.759A
0.7A	299 Ω	0.548A	0.880A
0.8A	263 Ω	0.634A	1.001A
0.9A	235 Ω	0.722A	1.121A

TABLE 5-3: MIC20X9 R_{SET} TABLE

I_{OUT}	R_{SET}	I_{LIMIT_MIN}	I_{LIMIT_MAX}
0.2A	1125 Ω	0.127A	0.267A
0.3A	765 Ω	0.202A	0.390A
0.4A	582 Ω	0.281A	0.510A
0.5A	470 Ω	0.361A	0.629A
0.6A	395 Ω	0.443A	0.746A
0.7A	341 Ω	0.526A	0.861A
0.8A	300 Ω	0.610A	0.976A
0.9A	268 Ω	0.695A	1.089A
1A	243 Ω	0.781A	1.202A
1.1A	222 Ω	0.868A	1.314A
1.2A	204 Ω	0.956A	1.426A
1.3A	189 Ω	1.044A	1.537A
1.4A	176 Ω	1.133A	1.647A
1.5A	165 Ω	1.222A	1.757A

5.2 I_{LIMIT} vs. I_{OUT} Measured

The MIC20XX's current-limiting circuitry, during current limiting, is designed to act as a constant current source to the load. As the load tries to pull more than the allotted current, V_{OUT} drops and the input to output voltage differential increases. When $V_{IN} - V_{OUT}$ exceeds 1V, I_{OUT} drops below I_{LIMIT} to reduce the drain of fault current on the system's power supply and to limit internal heating of the switch.

When measuring I_{OUT} it is important to bear this voltage dependence in mind, otherwise the measurement data may appear to indicate a problem when none really exists. This voltage dependence is illustrated in Figure 5-1 and Figure 5-2.

In Figure 5-1, output current is measured as V_{OUT} is pulled below V_{IN} , with the test terminating when V_{OUT} is 1V below V_{IN} . Observe that once I_{LIMIT} is reached I_{OUT} remains constant throughout the remainder of the test. In Figure 5-2 this test is repeated but with $V_{IN} - V_{OUT}$ exceeding 1V.

When $V_{IN} - V_{OUT} > 1V$, the switch's current limiting circuitry responds by decreasing I_{OUT} , as can be seen in Figure 5-2. In this demonstration, V_{OUT} is being controlled and I_{OUT} is the measured quantity. In real life applications V_{OUT} is determined in accordance with ohm's law by the load and the limiting current.

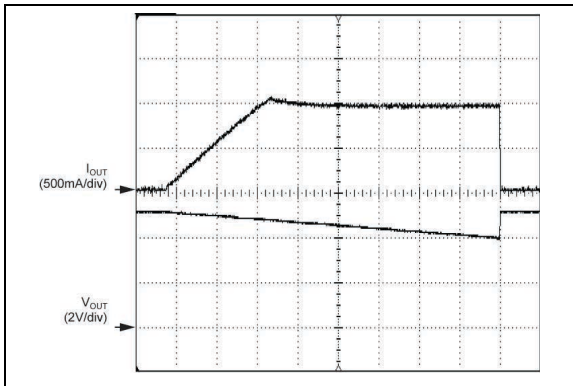

FIGURE 5-1: I_{OUT} in Current Limiting for $V_{IN} - V_{OUT} < 1V$.

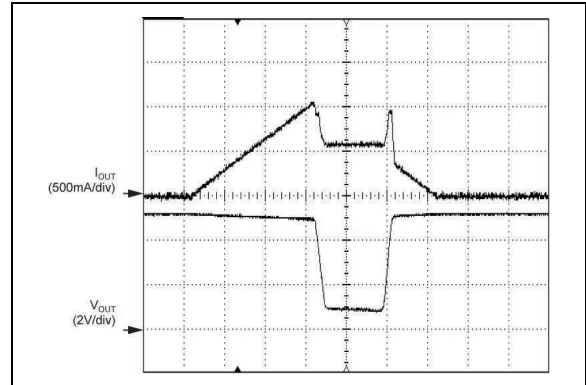

FIGURE 5-2: I_{OUT} in Current Limiting for $V_{IN} - V_{OUT} > 1V$.

This folding back of I_{LIMIT} can be generalized by plotting I_{LIMIT} as a function of V_{OUT} , as shown below in Figure 5-3 and Figure 5-4. The slope of V_{OUT} between $I_{OUT} = 0V$ and $I_{OUT} = I_{LIMIT}$ (where $I_{LIMIT} = 1A$) is determined by R_{ON} of the switch and I_{LIMIT} .

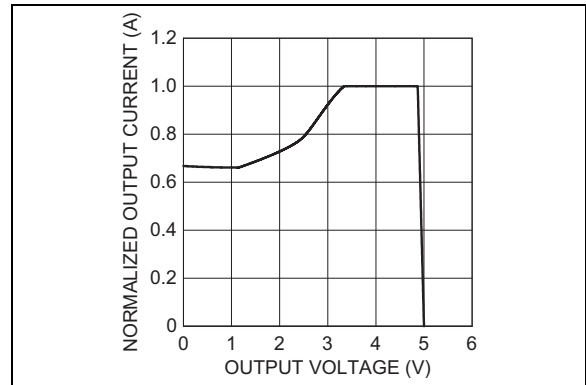

FIGURE 5-3: Normalized Output Current vs. Output Voltage (5V).

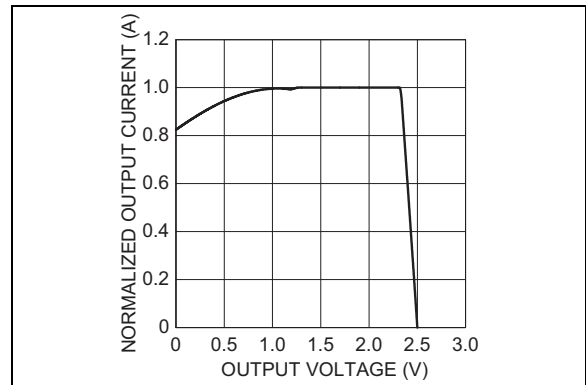

FIGURE 5-4: Normalized Output Current vs. Output Voltage (2.5V).

5.3 CSLEW

TABLE 5-4: CSLEW

2003	2004	2005X	2006	2007	2008	2009X
2013	2014	2015	2016	2017	2018	2019X

Note: Only parts in **bold** have CSLEW pin. (Not available in 5-pin SOT-23 packages).

The CSLEW pin is provided to increase control of the output voltage ramp at turn-on. This input allows designers the option of decreasing the output's slew rate (slowing the voltage rise) by adding an external capacitance between the CSLEW and VIN pins. This capacitance slows the rate at which the pass FET gate voltage increases and thus, slows both the response to an enable command as well as V_{OUT} 's ascent to its final value.

Figure 5-5 illustrates effect of CSLEW on turn-on delay and output rise time.

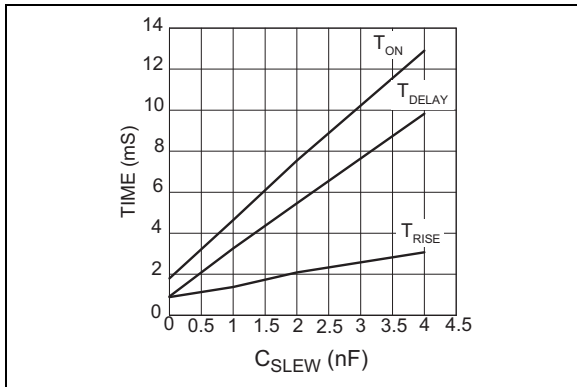

FIGURE 5-5: C_{SLEW} vs. Turn-On, Delay and Rise Times.

5.3.1 C_{SLEW} 'S EFFECT ON ILIMIT

An unavoidable consequence of adding C_{SLEW} capacitance is a reduction in the MIC20X5 - 20X8's ability to quickly limit current transients or surges. A sufficiently large capacitance can prevent both the primary and secondary current limits from acting in time to prevent damage to the MIC20X5 - 20X8 or the system from a short circuit fault. For this reason, the upper limit on the value of C_{SLEW} is 4 nF.

5.4 Variable Undervoltage Lockout (VUVLO)

TABLE 5-5: VARIABLE UNDERVOLTAGE LOCKOUT (VUVLO)

2003	2004	2005X	2006	2007	2008	2009X
2013	2014	2015	2016	2017	2018	2019X

Note: Only parts in **bold** have VUVLO pin and functionality.

Power-conscious systems, such as those implementing ACPI, will remain active even in their low-power states and may require the support of external devices through both phases of operation. Under these conditions, the current allowed these external devices may vary according to the system's operating state and as such require dual current limits on their peripheral ports. The MIC20X6 is designed for systems demanding two primary current limiting levels but without the use of a control signal to select between current limits.

To better understand how the MIC20X6 provides this, imagine a system whose main power supply supports heavy loads during normal operation, but in sleep mode is reduced to only few hundred milliamps of output current. In addition, this system has several USB ports which must remain active during sleep. During normal operation, each port can support a 500 mA peripheral, but in sleep mode their combined output current is limited to what the power supply can deliver minus whatever the system itself is drawing.

If a peripheral device is plugged in which demands more current than is available, the system power supply will sag, or crash. The MIC20X6 prevents this by monitoring both the load current and V_{IN} . During normal operation, when the power supply can source plenty of current, the MIC20X6 will support any load up to its factory programmed current limit. When the weaker, standby supply is in operation, the MIC20X6 monitors V_{IN} and will shut off its output should V_{IN} dip below a predetermined value. This predetermined voltage is user programmable and set by the selection of the resistor divider driving the VUVLO pin.

To prevent false triggering of the VUVLO feature, the MIC20X6 includes a delay timer to blank out momentary excursions below the VUVLO trip point. If V_{IN} stays below the VUVLO trip point for longer than 32 ms (typical), then the load is disengaged and the MIC20X6 will wait 128 ms before reapplying power to the load. If V_{IN} remains below the VUVLO trip point, then the load will be powered for the 32 ms blanking period and then again disengaged. This is illustrated in the scope plot below. If V_{IN} remains above the VUVLO trip point MIC20X6 resumes normal operation.

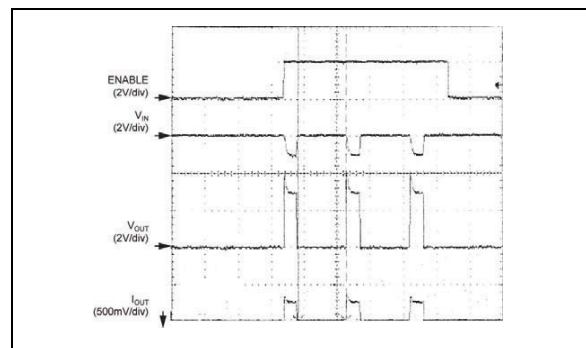

FIGURE 5-6: VUVLO Operation.

VUVLO and Kickstart operate independently in the MIC2016. If the high current surge allowed by Kickstart causes V_{IN} to dip below the VUVLO trip point for more than 32 ms, VUVLO will disengage the load, even though the Kickstart timer has not timed out.

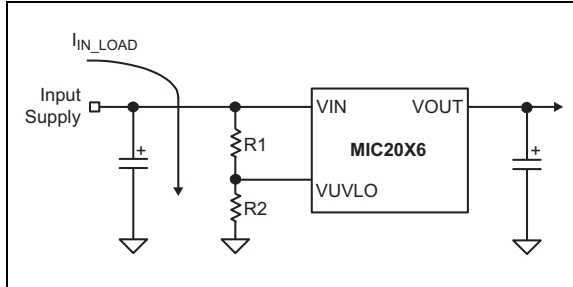

FIGURE 5-7: VUVLO Application Circuit.

5.4.1 CALCULATING VUVLO RESISTOR DIVIDER VALUES

The VUVLO feature is designed to keep the internal switch off until the voltage on the VUVLO pin is greater than 0.25V. A resistor divider network connected to the VUVLO and VIN pins is used to set the input trip voltage V_{TRIP} (see Figure 5-7). The value of R2 is chosen to minimize the load on the input supply I_{DIV} and the value of R1 sets the trip voltage V_{TRIP} .

The value of R2 is calculated using:

EQUATION 5-5:

$$R2 = \frac{V_{VUVLO}}{I_{DIV}}$$

The value of R1 is calculated using:

EQUATION 5-6:

$$R1 = R2 \times \left(\frac{V_{TRIP}}{V_{VUVLO}} - 1 \right)$$

Where for Equation 5-5 and Equation 5-6: $V_{VUVLO} = 0.25V$

When working with large value resistors, a small amount of leakage current from the VUVLO terminal can cause voltage offsets that degrade system accuracy. Therefore, the maximum recommended resistor value for R2 is 100 k Ω .

Using the divider loading current I_{DIV} of 100 μA , the value of R2 can be estimated by:

EQUATION 5-7:

$$R2 = \frac{0.25V}{100\mu A} = 2.5k\Omega$$

Now the value of R1 can be calculated by:

EQUATION 5-8:

$$R1 = 2.5k\Omega \times \left(\frac{4.75V}{0.25V} - 1 \right) = 45k\Omega$$

Where:

$V_{TRIP} = 4.75V$ (for a 5V supply)

$V_{VUVLO} = 0.25V$

The VUVLO comparator uses no hysteresis. This is because the VUVLO blanking timer prevents any chattering that might otherwise occur if V_{IN} varies about the trigger point. The timer is reset by upward crossings of the trip point such that V_{IN} must remain below the trip point for the full 32 ms period for load disengagement to occur.

In selecting a V_{TRIP} voltage, the designer is cautioned to not make this value less than 2.5V. A minimum of 2.5V is required for the MIC20X6's internal circuitry to operate properly. VUVLO trip points below 2.5V will result in erratic or unpredictable operation.

5.5 Kickstart

TABLE 5-6: KICKSTART

2003	2004	2005X	2006	2007	2008	2009X
2013	2014	2015	2016	2017	2018	2019X

Note: Only parts in **bold** have Kickstart (Not available in 5-pin SOT-23 packages).

Kickstart allows brief current surges to pass to the load before the onset of normal current limiting, which permits dynamic loads to draw bursts of energy without sacrificing system safety.

Functionally, Kickstart is a forced override of the normal current limiting function provided by the switch. The Kickstart period is governed by an internal timer which allows current to pass up to the secondary current limit (I_{LIMIT_2nd}) to the load for 128 ms and then normal (primary) current limiting goes into action.

During Kickstart, a secondary current-limiting circuit is monitoring output current to prevent damage to the switch, as a hard short combined with a robust power supply can result in currents of many tens of amperes. This secondary current limit is nominally set at 4A and reacts immediately and independently of the Kickstart

period. Once the Kickstart timer has finished its count the primary current limiting circuit takes over and holds I_{OUT} to its programmed limit for as long as the excessive load persists.

Once the switch drops out of current limiting the Kickstart timer initiates a lock-out period of 128 ms such that no further bursts of current above the primary current limit, will be allowed until the lock-out period has expired.

Kickstart may be over-ridden by the thermal protection circuit and if sufficient internal heating occurs, Kickstart will be terminated and $I_{OUT} \rightarrow 0A$. Upon cooling, if the load is still present $I_{OUT} \rightarrow I_{LIMIT}$, not I_{LIMIT_2nd} .

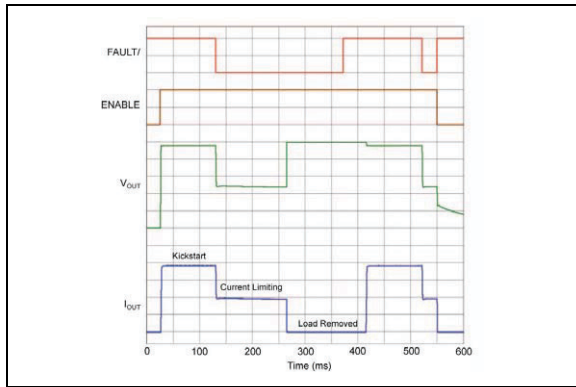

FIGURE 5-8: Kickstart.

5.6 Automatic Load Discharge

TABLE 5-7: AUTOMATIC LOAD DISCHARGE

2003	2004	2005X	2006	2007	2008	2009X
2013	2014	2015	2016	2017	2018	2019X

Note: Only parts in **bold** have automatic load discharge.

Automatic discharge is a valuable feature when it is desirable to quickly remove charge from the VOUT pin. This allows for a quicker power-down of the load. This also prevents any charge from being presented to a device being connected to the VOUT pin, for example, USB, 1394, PCMCIA, and CableCARD.

Automatic discharge is performed by a shunt MOSFET from VOUT pin to GND. When the switch is disabled, a break before make action is performed turning off the main power MOSFET and then enabling the shunt MOSFET. The total resistance of the MOSFET and internal resistances is typically 126Ω.

5.7 Supply Filtering

A minimum 1 μF bypass capacitor positioned close to the VIN and GND pins of the switch is both good design practice and required for proper operation of the switch. This will control supply transients and ringing. Without a bypass capacitor, large current surges or a short may cause sufficient ringing on V_{IN} (from supply lead inductance) to cause erratic operation of the switch's control circuitry. For best-performance good quality, low-ESR capacitors are recommended, preferably ceramic.

When bypassing with capacitors of 10 μF and up, it is good practice to place a smaller value capacitor in parallel with the larger to handle the high frequency components of any line transients. Values in the range of 0.01 μF to 0.1 μF are recommended. Again, good quality, low-ESR capacitors should be chosen.

5.8 Power Dissipation

Power dissipation depends on several factors such as the load, PCB layout, ambient temperature, and supply voltage. Calculation of power dissipation can be accomplished by the following equation:

EQUATION 5-9:

$$P_D = R_{DS(ON)} \times (I_{OUT})^2$$

To relate this to junction temperature, the following equation can be used:

EQUATION 5-10:

$$T_J = P_D \times R_{\theta(J-A)} + T_A$$

Where:

T_J = Junction temperature

T_A = Ambient temperature

$R_{\theta(J-A)}$ = The thermal resistance of the package

In normal operation the switch's R_{ON} is low enough that no significant I^2R heating occurs. Device heating is most often caused by a short circuit, or very heavy load, when a significant portion of the input supply voltage appears across the switch's power MOSFET. Under these conditions the heat generated will exceed the package and PCB's ability to cool the device and thermal limiting will be invoked.

In [Figure 5-9](#), die temperature is plotted against I_{OUT} assuming a constant case temperature of 85°C . The plots also assume a worst case R_{ON} of $140\text{ m}\Omega$ at a die temperature of 135°C . Under these conditions it is clear that an SOT-23 packaged device will be on the verge of thermal shutdown, typically 140°C die temperature, when operating at a load current of 1.25A . For this reason we recommend using DFN packaged switches for any design intending to supply continuous currents of 1A or more.

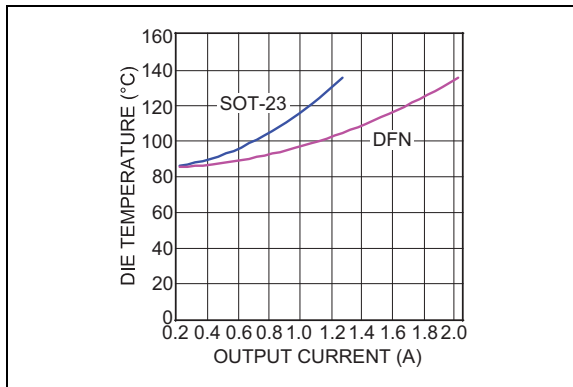

FIGURE 5-9: Die Temperature vs. I_{OUT}
($T_{CASE} = 85^{\circ}\text{C}$).

MIC20XX

6.0 PACKAGING INFORMATION

6.1 Package Marking Information

5-Lead SOT-23* (Front)	Example	5-Lead SOT-23* (Back)	Example
XXXX	FD08	NNN	6SC
6-Lead SOT-23* (Front)	Example	5-Lead SOT-23* (Back)	Example
● XXXX	● FA54	NNN	WS7
	6-Lead DFN*	Example	
	● — XXX NNN	● — QAA 6D8	

Legend:	XX...X	Product code or customer-specific information
	Y	Year code (last digit of calendar year)
	YY	Year code (last 2 digits of calendar year)
	WW	Week code (week of January 1 is week '01')
	NNN	Alphanumeric traceability code
	(e3)	Pb-free JEDEC® designator for Matte Tin (Sn)
	*	This package is Pb-free. The Pb-free JEDEC designator ((e3)) can be found on the outer packaging for this package.
	●, ▲, ▼	Pin one index is identified by a dot, delta up, or delta down (triangle mark).
Note:	In the event the full Microchip part number cannot be marked on one line, it will be carried over to the next line, thus limiting the number of available characters for customer-specific information. Package may or may not include the corporate logo.	
	Underbar (_) and/or Overbar (¯) symbol may not be to scale.	

Note: If the full seven-character YYWWNNN code cannot fit on the package, the following truncated codes are used based on the available marking space:
 6 Characters = YWWNNN; 5 Characters = WWNNN; 4 Characters = WNNN; 3 Characters = NNN;
 2 Characters = NN; 1 Character = N

5-Lead SOT-23 (M5) Package Outline & Recommended Land Pattern

TITLE

5 LEAD SOT23 PACKAGE OUTLINE & RECOMMENDED LAND PATTERN

DRAWING #	SOT23-5LD-PL-1	UNIT	MM
------------------	----------------	-------------	----

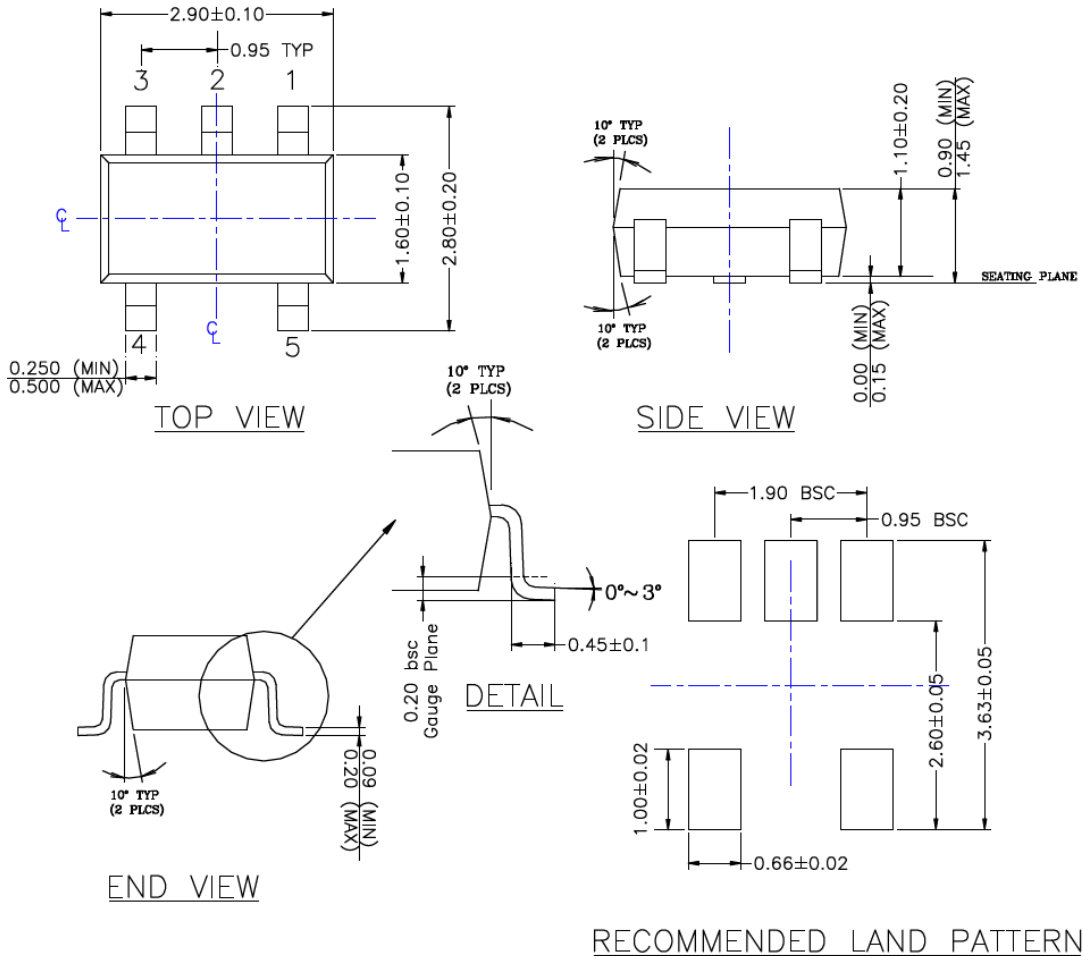

NOTE:

1. PACKAGE OUTLINE EXCLUSIVE OF MOLD FLASH & BURR.
2. PACKAGE OUTLINE INCLUSIVE OF SOLER PLATING.
3. DIMENSION AND TOLERANCE PER ANSI Y14.5M, 1982.
4. FOOT LENGTH MEASUREMENT BASED ON GAUGE PLANE METHOD.
5. DIE FACES UP FOR MOLD, AND FACES DOWN FOR TRIM/FORM.
6. ALL DIMENSIONS ARE IN MILLIMETERS.

Note: For the most current package drawings, please see the Microchip Packaging Specification located at <http://www.microchip.com/packaging>.

MIC20XX

6-Lead SOT-23 (M6) Package Outline & Recommended Land Pattern

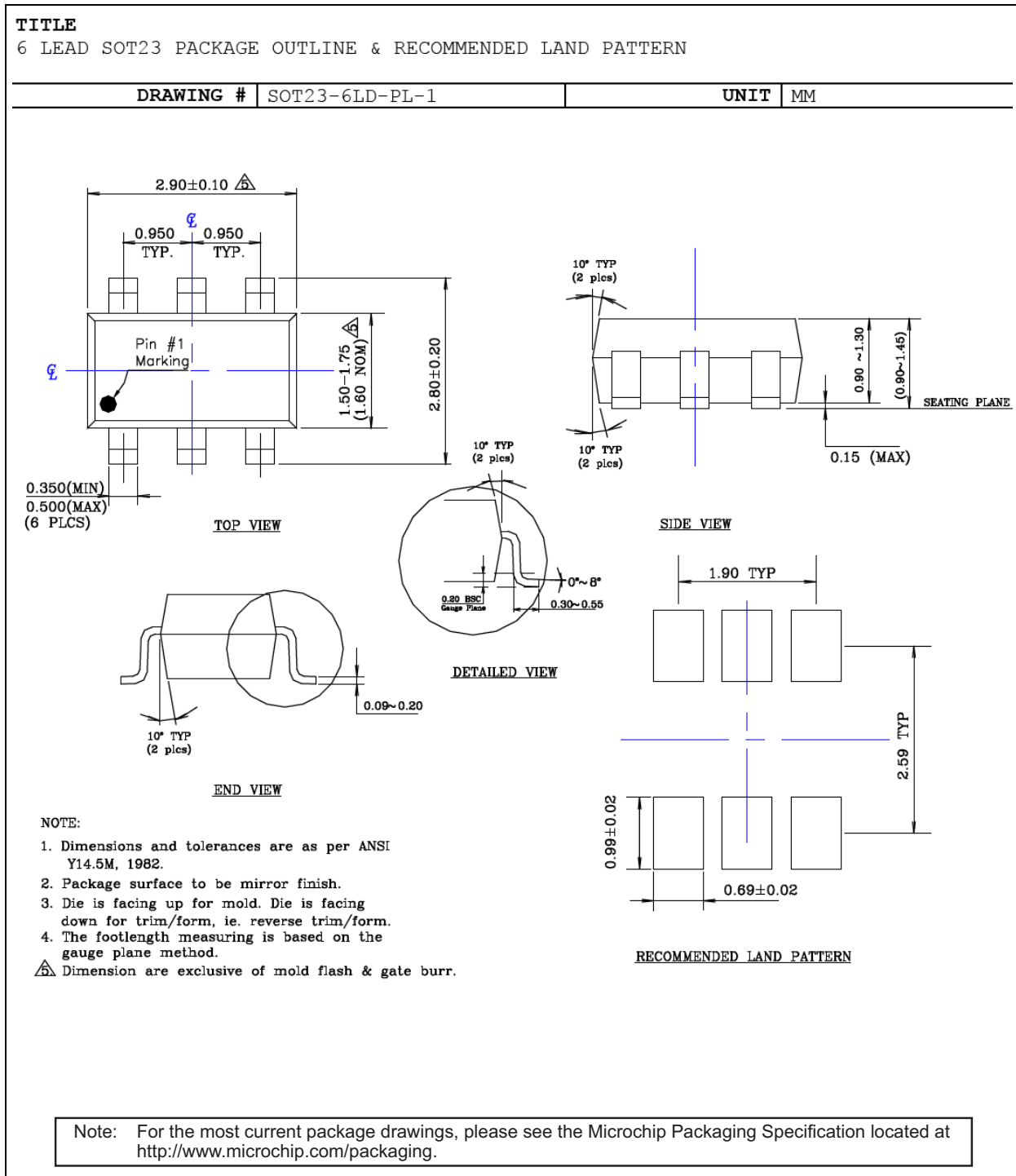

6-Lead DFN 2 mm x 2 mm Package Outline & Recommended Land Pattern

TITLE

6 LEAD DFN 2x2mm PACKAGE OUTLINE & RECOMMENDED LAND PATTERN

DRAWING #	DFN22-6LD-PL-1	UNIT	MM
-----------	----------------	------	----

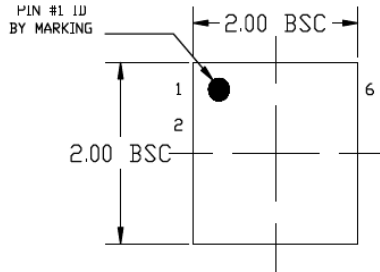

TOP VIEW

NOTE: 1, 2, 3

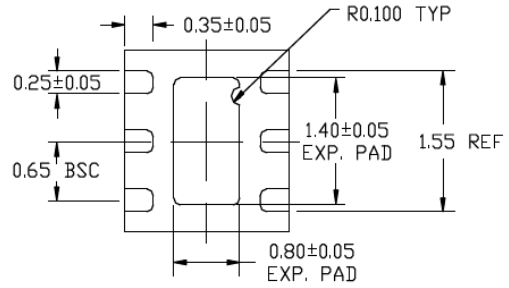

BOTTOM VIEW

NOTE: 1, 2, 3

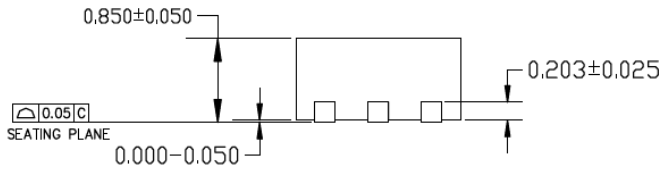

END VIEW

NOTE: 1, 2, 3

NOTE:

1. MAX PACKAGE WARPAGE IS 0.05 MM
2. MAX ALLOWABLE BURR IS 0.076MM IN ALL DIRECTIONS
3. PIN #1 IS ON TOP WILL BE LASER MARKED
4. RED CIRCLE IN LAND PATTERN INDICATE THERMAL VIA. SIZE SHOULD BE 0.30-0.3MM IN DIAMETER AND SHOULD BE CONNECTED TO GND FOR MAX THERMAL PERFORMANCE
5. GREEN RECTANGLES (SHADED AREA) INDICATE SOLDER STENCIL OPENING ON EXPOSED PAD AREA. SIZE SHOULD BE 0.60x0.40 MM IN SIZE, 0.20 MM SPACING.

Note: For the most current package drawings, please see the Microchip Packaging Specification located at <http://www.microchip.com/packaging>.

MIC20XX

POD-Land Pattern drawing # DFN22-6LD-PL-1

RECOMMENDED LAND PATTERN

NOTE: 4,5

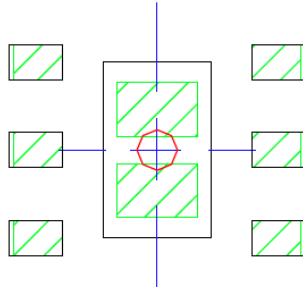

STACKED-UP

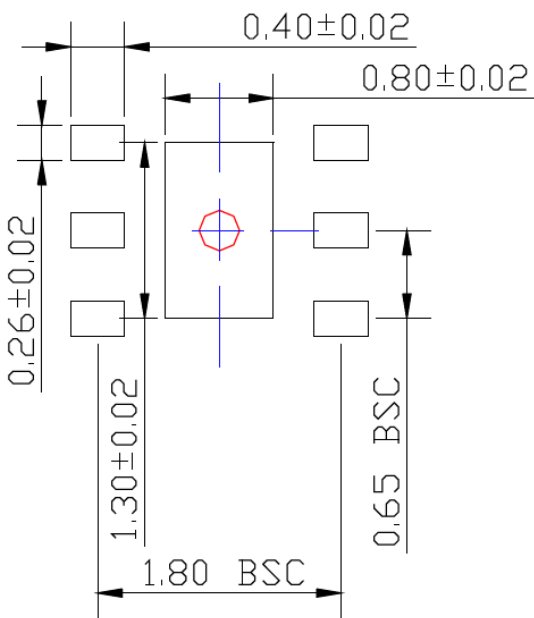

EXPOSED METAL TRACE

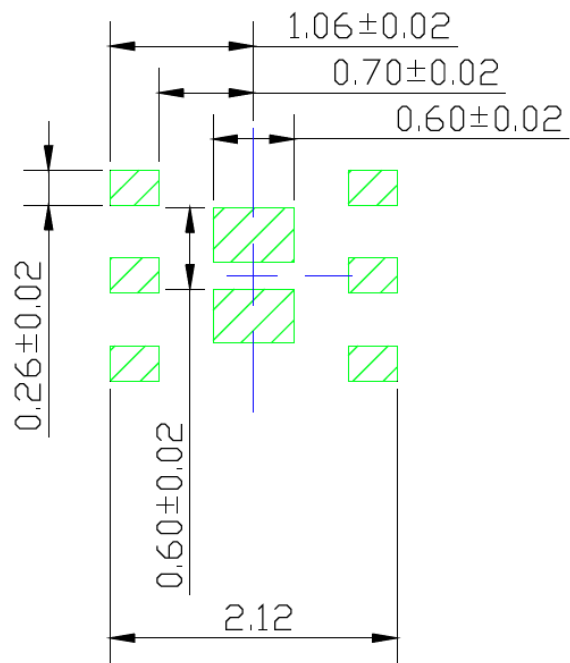

SOLDER STENCIL OPENING

Note: For the most current package drawings, please see the Microchip Packaging Specification located at <http://www.microchip.com/packaging>.

APPENDIX A: REVISION HISTORY

Revision A (January 2021)

- Converted Micrel document MIC20XX to Microchip data sheet template DS20006486A.
- Minor grammatical text changes throughout.

Revision B (February 2021)

- [Figure 2-23](#) ($V_{IN} = 3.3V$) was a repeat of [Figure 2-22](#) ($V_{IN} = 5.0$) by mistake and is the corrected graph now.

Revision C (February 2022)

- Updated Pin Diagram for MIC20X5 (6-Pin DFN version) in the [MIC20XX Family Package Types](#) section.
- Updated the [Package Marking Information](#) drawing to reflect the most current information.
- Minor grammatical and stylistic corrections throughout.

MIC20XX

NOTES:

PRODUCT IDENTIFICATION SYSTEM

To order or obtain information, e.g., on pricing or delivery, contact your local Microchip representative or sales office.

MIC2003/MIC2013					
Full Part No. (Note 1)	Marking (Note 2)	Current Limit	Kickstart	Package	Media Type
MIC2003-0.5YM5-TR	FD05	0.5A	No	5-Lead SOT-23	3,000/Reel
MIC2003-0.8YM5-TR	FD08	0.8A			
MIC2003-1.2YM5-TR	FD12	1.2A			
MIC2003-0.5YML-TR	D05	0.5A		6-Lead 2 mm x 2 mm DFN	5,000/Reel
MIC2003-0.8YML-TR	D08	0.8A			
MIC2003-1.2YML-TR	D12	1.2A			
MIC2013-0.5YM5-TR	FL05	0.5A	Yes	5-Lead SOT-23	3,000/Reel
MIC2013-0.8YM5-TR	FL08	0.8A			
MIC2013-1.2YM5-TR	FL12	1.2A			
MIC2013-0.5YML-TR	L05	0.5A		6-Lead 2 mm x 2 mm DFN	5,000/Reel
MIC2013-0.8YML-TR	L08	0.8A			
MIC2013-1.2YML-TR	L12	1.2A			
MIC2004/MIC2014					
MIC2004-0.5YM5-TR	FE05	0.5A	No	5-Lead SOT-23	3,000/Reel
MIC2004-0.8YM5-TR	FE08	0.8A			
MIC2004-1.2YM5-TR	FE12	1.2A			
MIC2004-0.5YML-TR	E05	0.5A		6-Lead 2 mm x 2 mm DFN	5,000/Reel
MIC2004-0.8YML-TR	E08	0.8A			
MIC2004-1.2YML-TR	E12	1.2A			
MIC2014-0.5YM5-TR	FM05	0.5A	Yes	5-Lead SOT-23	3,000/Reel
MIC2014-0.8YM5-TR	FM08	0.8A			
MIC2014-1.2YM5-TR	FM12	1.2A			
MIC2014-0.5YML-TR	M05	0.5A		6-Lead 2 mm x 2 mm DFN	5,000/Reel
MIC2014-0.8YML-TR	M08	0.8A			
MIC2014-1.2YML-TR	M12	1.2A			
MIC2005/MIC2015					
MIC2005-0.5YM6-TR	FE05	0.5A	No	6-Lead SOT-23	3,000/Reel
MIC2005-0.8YM6-TR	FE08	0.8A			
MIC2005-1.2YM6-TR	FE12	1.2A			
MIC2005-0.5YML-TR	F05	0.5A		6-Lead 2 mm x 2 mm DFN	5,000/Reel
MIC2005-0.8YML-TR	F08	0.8A			
MIC2005-1.2YML-TR	F12	1.2A			
MIC2015-0.5YM6-TR	FN05	0.5A	Yes	6-Lead SOT-23	3,000/Reel
MIC2015-0.8YM6-TR	FN08	0.8A			
MIC2015-1.2YM6-TR	FN12	1.2A			
MIC2015-0.5YML-TR	N05	0.5A		6-Lead 2 mm x 2 mm DFN	5,000/Reel
MIC2015-0.8YML-TR	N08	0.8A			
MIC2015-1.2YML-TR	N12	1.2A			

MIC20XX

PRODUCT IDENTIFICATION SYSTEM (CONTINUED)

To order or obtain information, e.g., on pricing or delivery, contact your local Microchip representative or sales office.

Full Part No.	Marking	Current Limit	Kickstart	Package	Media Type
MIC2005A					
MIC2005A-1YM5-TR	FA51	0.5A	No	5-Lead SOT-23	3,000/Reel
MIC2005A-2YM5-TR	FA52	0.5A			
MIC2005A-1YM6-TR	FA53	0.5A			
MIC2005A-2YM6-TR	FA54	0.5A		6-Lead SOT-23	
MIC2005L					
MIC2005-0.5LYM5	5LFF	0.5A	No	5-Lead SOT-23	3,000/Reel
MIC2005-0.8LYM5	8LFF	0.8A			
MIC2005-1.2LYM5	4LFF	1.2A			
MIC2006/MIC2016					
MIC2006-0.5YM6-TR	FG05	0.5A	No	6-Lead SOT-23	3,000/Reel
MIC2006-0.8YM6-TR	FG08	0.8A			
MIC2006-1.2YM6-TR	FG12	1.2A			
MIC2006-0.5YML-TR	G05	0.5A		6-Lead 2 mm x 2 mm DFN	5,000/Reel
MIC2006-0.8YML-TR	G08	0.8A			
MIC2006-1.2YML-TR	G12	1.2A			
MIC2016-0.5YM6-TR	FP05	0.5A	Yes	6-Lead SOT-23	3,000/Reel
MIC2016-0.8YM6-TR	FP08	0.8A			
MIC2016-1.2YM6-TR	FP12	1.2A			
MIC2016-0.5YML-TR	P05	0.5A		6-Lead 2 mm x 2 mm DFN	5,000/Reel
MIC2016-0.8YML-TR	P08	0.8A			
MIC2016-1.2YML-TR	P12	1.2A			
MIC2007/MIC2017					
MIC2007YM6-TR	FHAA	0.2A - 2.0A	No	6-Lead SOT-23	3,000/Reel
MIC2007YML-TR	HAA			6-Lead 2 mm x 2 mm DFN	5,000/Reel
MIC2017YM6-TR	FQAA		Yes	6-Lead SOT-23	3,000/Reel
MIC2017YML-TR	QAA			6-Lead 2 mm x 2 mm DFN	5,000/Reel
MIC2008/MIC2018					
MIC2008YM6-TR	FJAA	0.2A - 2.0A	No	6-Lead SOT-23	3,000/Reel
MIC2008YML-TR	JAA			6-Lead 2 mm x 2 mm DFN	5,000/Reel
MIC2018YM6-TR	FRAA		Yes	6-Lead SOT-23	3,000/Reel
MIC2018YML-TR	RAA			6-Lead 2 mm x 2 mm DFN	5,000/Reel
MIC2009/MIC2019					
MIC2009YM6-TR	FKAA	0.2A - 2.0A	No	6-Lead SOT-23	3,000/Reel
MIC2009YML-TR	KAA			6-Lead 2 mm x 2 mm DFN	5,000/Reel
MIC2019YM6-TR	FSAA		Yes	6-Lead SOT-23	3,000/Reel
MIC2019YML-TR	SAA			6-Lead 2 mm x 2 mm DFN	5,000/Reel

PRODUCT IDENTIFICATION SYSTEM (CONTINUED)

To order or obtain information, e.g., on pricing or delivery, contact your local Microchip representative or sales office.

Full Part No.	Marking	Current Limit	Kickstart	Package	Media Type
MIC2009A/MIC2019A					
MIC2009A-1YM6-TR	FK1	0.1A - 0.9A	No	6-Lead SOT-23	3,000/Reel
MIC2009A-2YM6-TR	FK2		No		3,000/Reel
MIC2019A-1YM6-TR	FS1		Yes		3,000/Reel
MIC2019A-2YM6-TR	FS2		Yes		3,000/Reel

Note 1: All MIC20XX Family parts are RoHS-compliant lead .

2: Over/Underbar symbol (¯ / _) may not be to scale. On the package the over/under symbol begins above/below the first character of the marking.

MIC20XX FAMILY MEMBER FUNCTIONALITY

Part Number		I _{LIMIT}	Pin Function						
Normal Limiting	Kickstart Note 1		I _{LIMIT}	ENABLE High	ENABLE Low	CSLEW	FAULT/	VUVLO Note 4	Load Discharge
2003	2013	Fixed Note 2	—	—	—	—	—	—	—
2004	20014		—	▲	—	—	—	—	▲
2005	2015		—	▲	—	▲	▲	—	—
2005L	—		—	—	▲	—	▲	—	—
2005A-1	—		—	▲	—	Note 5	▲	—	—
2005A-2	—		—	—	▲	Note 5	▲	—	—
2006	2016		—	▲	—	▲	—	▲	—
2007	2017	Adj. Note 3	▲	▲	—	▲	—	—	▲
2008	2018		▲	▲	—	▲	—	—	—
2009	2019		▲	▲	—	—	▲	—	—
2009A-1	2019A-1		▲	▲	—	—	▲	—	—
2009A-2	2019A-2		▲	—	▲	—	▲	—	—

Note 1: Kickstart provides an alternate start-up behavior; however, pinouts are identical.

2: Fixed = Factory programmed current limit.

3: Adjustable = User adjustable current limit.

4: VUVLO = Variable UVLO (previously called DML).

5: CSLEW, while available in 6-pin package, not available in 5-pin package.

MIC20XX

NOTES:

Note the following details of the code protection feature on Microchip products:

- Microchip products meet the specifications contained in their particular Microchip Data Sheet.
- Microchip believes that its family of products is secure when used in the intended manner, within operating specifications, and under normal conditions.
- Microchip values and aggressively protects its intellectual property rights. Attempts to breach the code protection features of Microchip product is strictly prohibited and may violate the Digital Millennium Copyright Act.
- Neither Microchip nor any other semiconductor manufacturer can guarantee the security of its code. Code protection does not mean that we are guaranteeing the product is “unbreakable”. Code protection is constantly evolving. Microchip is committed to continuously improving the code protection features of our products.

This publication and the information herein may be used only with Microchip products, including to design, test, and integrate Microchip products with your application. Use of this information in any other manner violates these terms. Information regarding device applications is provided only for your convenience and may be superseded by updates. It is your responsibility to ensure that your application meets with your specifications. Contact your local Microchip sales office for additional support or, obtain additional support at <https://www.microchip.com/en-us/support/design-help/client-support-services>.

THIS INFORMATION IS PROVIDED BY MICROCHIP "AS IS". MICROCHIP MAKES NO REPRESENTATIONS OR WARRANTIES OF ANY KIND WHETHER EXPRESS OR IMPLIED, WRITTEN OR ORAL, STATUTORY OR OTHERWISE, RELATED TO THE INFORMATION INCLUDING BUT NOT LIMITED TO ANY IMPLIED WARRANTIES OF NON-INFRINGEMENT, MERCHANTABILITY, AND FITNESS FOR A PARTICULAR PURPOSE, OR WARRANTIES RELATED TO ITS CONDITION, QUALITY, OR PERFORMANCE.

IN NO EVENT WILL MICROCHIP BE LIABLE FOR ANY INDIRECT, SPECIAL, PUNITIVE, INCIDENTAL, OR CONSEQUENTIAL LOSS, DAMAGE, COST, OR EXPENSE OF ANY KIND WHATSOEVER RELATED TO THE INFORMATION OR ITS USE, HOWEVER CAUSED, EVEN IF MICROCHIP HAS BEEN ADVISED OF THE POSSIBILITY OR THE DAMAGES ARE FORESEEABLE. TO THE FULLEST EXTENT ALLOWED BY LAW, MICROCHIP'S TOTAL LIABILITY ON ALL CLAIMS IN ANY WAY RELATED TO THE INFORMATION OR ITS USE WILL NOT EXCEED THE AMOUNT OF FEES, IF ANY, THAT YOU HAVE PAID DIRECTLY TO MICROCHIP FOR THE INFORMATION.

Use of Microchip devices in life support and/or safety applications is entirely at the buyer's risk, and the buyer agrees to defend, indemnify and hold harmless Microchip from any and all damages, claims, suits, or expenses resulting from such use. No licenses are conveyed, implicitly or otherwise, under any Microchip intellectual property rights unless otherwise stated.

For information regarding Microchip's Quality Management Systems, please visit www.microchip.com/quality.

Trademarks

The Microchip name and logo, the Microchip logo, Adaptec, AnyRate, AVR, AVR logo, AVR Freaks, BesTime, BitCloud, CryptoMemory, CryptoRF, dsPIC, flexPWR, HELDO, IGLOO, JukeBlox, KeeLoq, Klear, LANCheck, LinkMD, maXStylus, maXTouch, MediaLB, megaAVR, Microsemi, Microsemi logo, MOST, MOST logo, MPLAB, OptoLyzer, PIC, picoPower, PICSTART, PIC32 logo, PolarFire, Prochip Designer, QTouch, SAM-BA, SenGenuity, SpyNIC, SST, SST Logo, SuperFlash, Symmetricom, SyncServer, Tachyon, TimeSource, tinyAVR, UNI/O, Vectron, and XMEGA are registered trademarks of Microchip Technology Incorporated in the U.S.A. and other countries.

AgileSwitch, APT, ClockWorks, The Embedded Control Solutions Company, EtherSynch, Flashtec, Hyper Speed Control, HyperLight Load, IntelliMOS, Libero, motorBench, mTouch, Powermite 3, Precision Edge, ProASIC, ProASIC Plus, ProASIC Plus logo, QuietWire, SmartFusion, SyncWorld, Temux, TimeCesium, TimeHub, TimePictra, TimeProvider, TrueTime, WinPath, and ZL are registered trademarks of Microchip Technology Incorporated in the U.S.A.

Adjacent Key Suppression, AKS, Analog-for-the-Digital Age, Any Capacitor, AnyIn, AnyOut, Augmented Switching, BlueSky, BodyCom, CodeGuard, CryptoAuthentication, CryptoAutomotive, CryptoCompanion, CryptoController, dsPICDEM, dsPICDEM.net, Dynamic Average Matching, DAM, ECAN, Espresso T1S, EtherGREEN, GridTime, IdealBridge, In-Circuit Serial Programming, ICSP, INICnet, Intelligent Paralleling, Inter-Chip Connectivity, JitterBlocker, Knob-on-Display, maxCrypto, maxView, memBrain, Mindi, MiWi, MPASM, MPF, MPLAB Certified logo, MPLIB, MPLINK, MultiTRAK, NetDetach, NVM Express, NVMe, Omniscient Code Generation, PICDEM, PICDEM.net, PICkit, PICtail, PowerSmart, PureSilicon, QMatrix, REAL ICE, Ripple Blocker, RTAX, RTG4, SAM-ICE, Serial Quad I/O, simpleMAP, SimpliPHY, SmartBuffer, SmartHLS, SMART-I.S., storClad, SQI, SuperSwitcher, SuperSwitcher II, Switchtec, SynchroPHY, Total Endurance, TSHARC, USBCheck, VariSense, VectorBlox, VeriPHY, ViewSpan, WiperLock, XpressConnect, and ZENA are trademarks of Microchip Technology Incorporated in the U.S.A. and other countries.

SQTP is a service mark of Microchip Technology Incorporated in the U.S.A.

The Adaptec logo, Frequency on Demand, Silicon Storage Technology, Symmcom, and Trusted Time are registered trademarks of Microchip Technology Inc. in other countries.

GestIC is a registered trademark of Microchip Technology Germany II GmbH & Co. KG, a subsidiary of Microchip Technology Inc., in other countries.

All other trademarks mentioned herein are property of their respective companies.

© 2021 - 2022, Microchip Technology Incorporated and its subsidiaries.

All Rights Reserved.

ISBN: 978-1-5224-9820-9



MICROCHIP

Worldwide Sales and Service

AMERICAS

Corporate Office
2355 West Chandler Blvd.
Chandler, AZ 85224-6199
Tel: 480-792-7200
Fax: 480-792-7277
Technical Support:
<http://www.microchip.com/support>
Web Address:
www.microchip.com

Atlanta

Duluth, GA
Tel: 678-957-9614
Fax: 678-957-1455

Austin, TX

Tel: 512-257-3370

Boston

Westborough, MA
Tel: 774-760-0087
Fax: 774-760-0088

Chicago

Itasca, IL
Tel: 630-285-0071
Fax: 630-285-0075

Dallas

Addison, TX
Tel: 972-818-7423
Fax: 972-818-2924

Detroit

Novi, MI
Tel: 248-848-4000

Houston, TX

Tel: 281-894-5983

Indianapolis

Noblesville, IN
Tel: 317-773-8323
Fax: 317-773-5453
Tel: 317-536-2380

Los Angeles

Mission Viejo, CA
Tel: 949-462-9523
Fax: 949-462-9608
Tel: 951-273-7800

Raleigh, NC

Tel: 919-844-7510

New York, NY

Tel: 631-435-6000

San Jose, CA

Tel: 408-735-9110
Tel: 408-436-4270

Canada - Toronto

Tel: 905-695-1980
Fax: 905-695-2078

ASIA/PACIFIC

Australia - Sydney
Tel: 61-2-9868-6733

China - Beijing
Tel: 86-10-8569-7000

China - Chengdu
Tel: 86-28-8665-5511

China - Chongqing
Tel: 86-23-8980-9588

China - Dongguan
Tel: 86-769-8702-9880

China - Guangzhou
Tel: 86-20-8755-8029

China - Hangzhou
Tel: 86-571-8792-8115

China - Hong Kong SAR
Tel: 852-2943-5100

China - Nanjing
Tel: 86-25-8473-2460

China - Qingdao
Tel: 86-532-8502-7355

China - Shanghai
Tel: 86-21-3326-8000

China - Shenyang
Tel: 86-24-2334-2829

China - Shenzhen
Tel: 86-755-8864-2200

China - Suzhou
Tel: 86-186-6233-1526

China - Wuhan
Tel: 86-27-5980-5300

China - Xian
Tel: 86-29-8833-7252

China - Xiamen
Tel: 86-592-2388138

China - Zhuhai
Tel: 86-756-3210040

ASIA/PACIFIC

India - Bangalore
Tel: 91-80-3090-4444

India - New Delhi
Tel: 91-11-4160-8631

India - Pune
Tel: 91-20-4121-0141

Japan - Osaka
Tel: 81-6-6152-7160

Japan - Tokyo
Tel: 81-3-6880-3770

Korea - Daegu
Tel: 82-53-744-4301

Korea - Seoul
Tel: 82-2-554-7200

Malaysia - Kuala Lumpur
Tel: 60-3-7651-7906

Malaysia - Penang
Tel: 60-4-227-8870

Philippines - Manila
Tel: 63-2-634-9065

Singapore
Tel: 65-6334-8870

Taiwan - Hsin Chu
Tel: 886-3-577-8366

Taiwan - Kaohsiung
Tel: 886-7-213-7830

Taiwan - Taipei
Tel: 886-2-2508-8600

Thailand - Bangkok
Tel: 66-2-694-1351

Vietnam - Ho Chi Minh
Tel: 84-28-5448-2100

EUROPE

Austria - Wels
Tel: 43-7242-2244-39
Fax: 43-7242-2244-393

Denmark - Copenhagen
Tel: 45-4485-5910
Fax: 45-4485-2829

Finland - Espoo
Tel: 358-9-4520-820

France - Paris
Tel: 33-1-69-53-63-20
Fax: 33-1-69-30-90-79

Germany - Garching
Tel: 49-8931-9700

Germany - Haan
Tel: 49-2129-3766400

Germany - Heilbronn
Tel: 49-7131-72400

Germany - Karlsruhe
Tel: 49-721-625370

Germany - Munich
Tel: 49-89-627-144-0
Fax: 49-89-627-144-44

Germany - Rosenheim
Tel: 49-8031-354-560

Israel - Ra'anana
Tel: 972-9-744-7705

Italy - Milan
Tel: 39-0331-742611
Fax: 39-0331-466781

Italy - Padova
Tel: 39-049-7625286

Netherlands - Drunen
Tel: 31-416-690399
Fax: 31-416-690340

Norway - Trondheim
Tel: 47-7288-4388

Poland - Warsaw
Tel: 48-22-3325737

Romania - Bucharest
Tel: 40-21-407-87-50

Spain - Madrid
Tel: 34-91-708-08-90
Fax: 34-91-708-08-91

Sweden - Gothenberg
Tel: 46-31-704-60-40

Sweden - Stockholm
Tel: 46-8-5090-4654

UK - Wokingham
Tel: 44-118-921-5800
Fax: 44-118-921-5820