

Temp&Hum click

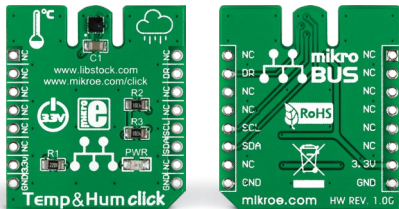

1. Introduction

Temp&Hum click carries ST's **HTS221** temperature and relative humidity sensor. The chip comprises a capacitive sensing element and a 16-bit ADC. The board communicates with the target MCU through mikroBUS™ I2C interface [SCL, SDA], with an additional interrupt [INT] which you can set as an alarm when a specified temperature or humidity value is reached. Designed to use a 3.3V power supply only.

2. Soldering the headers

Before using your click board™, make sure to solder 1x8 male headers to both left and right side of the board. Two 1x8 male headers are included with the board in the package.

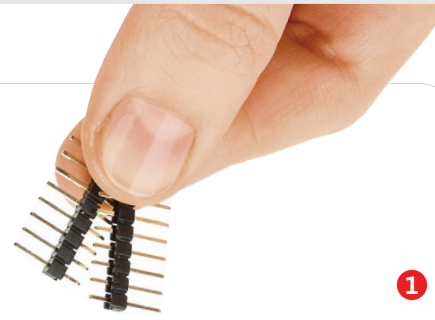

1

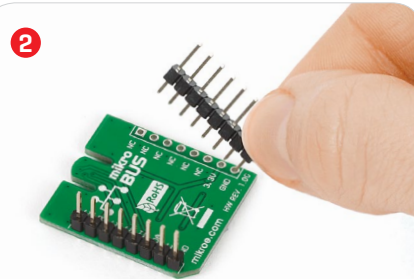

Turn the board upside down so that the bottom side is facing you upwards. Place shorter pins of the header into the appropriate soldering pads.

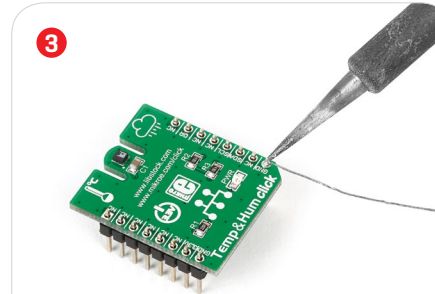

Turn the board upward again. Make sure to align the headers so that they are perpendicular to the board, then solder the pins carefully.

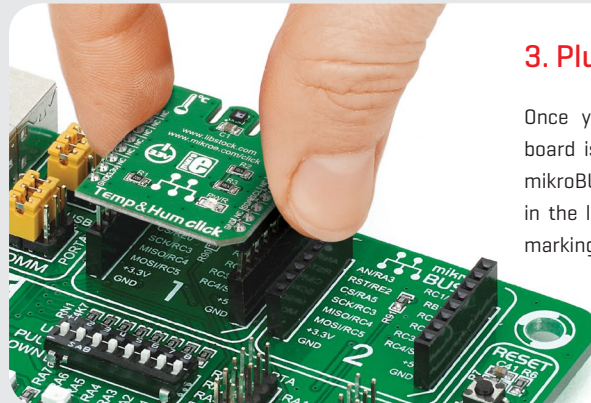

3. Plugging the board in

Once you have soldered the headers your board is ready to be placed into the desired mikroBUS™ socket. Make sure to align the cut in the lower-right part of the board with the markings on the silkscreen at the mikroBUS™ socket. If all the pins are aligned correctly, push the board all the way into the socket.

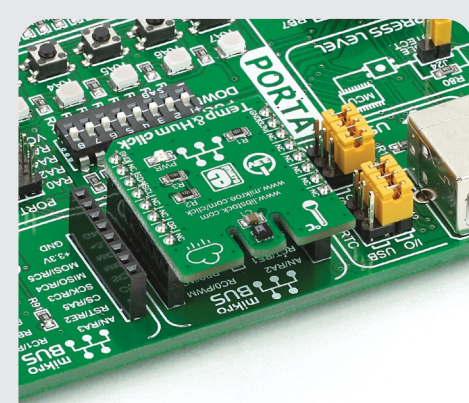

4. Essential features

Temp&Hum click has temperature measurement accuracy is $\pm 1^\circ\text{C}$ within a 0-60°C range. The precision is increased to $\pm 0.5^\circ\text{C}$ in a narrower range from 15 to 40°C. The relative humidity measurement range is from 0 to 100% with $\pm 6\%$ accuracy (or ± 4.5 in 20-80% range) The measurements are outputted in a 16-bit resolution.

click
BOARD™
www.mikroe.com



Temp&Hum click Manual v100



0100000084311

5. Schematic

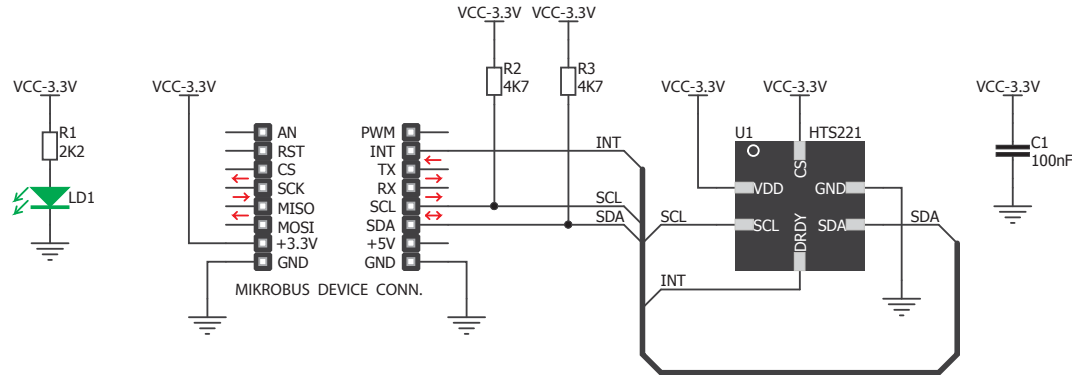

6. Dimensions

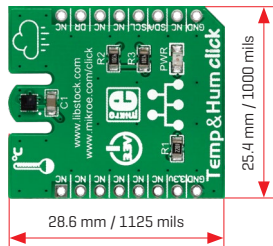

	mm	mils
LENGTH	28.6	1125
WIDTH	25.4	1000
HEIGHT*	3	118

* without headers

7. Temp&Hum alternatives

We have a wide range of temperature and humidity sensors in our click board range. For alternatives, visit:

<http://www.mikroe.com/click>

8. Code examples

Once you have done all the necessary preparations, it's time to get your click board™ up and running. We have provided examples for mikroC™, mikroBasic™ and mikroPascal™ compilers on our **Libstock** website. Just download them and you are ready to start.



9. Support

MikroElektronika offers **free tech support** [www.mikroe.com/support] until the end of the product's lifetime, so if something goes wrong, we're ready and willing to help!



10. Disclaimer

MikroElektronika assumes no responsibility or liability for any errors or inaccuracies that may appear in the present document. Specification and information contained in the present schematic are subject to change at any time without notice.

Copyright © 2015 MikroElektronika.
All rights reserved.