



FEATURES:

- RoHS Compliant
- High Efficiency up to 89%
- Low Ripple and Noise
- 7 pin SIP Package
- Operating Temperature -40°C to +85°C
- Pin Compatible with Multiple Manufacturers
- Input / Output Isolation 1000, 3000 VDC
- Non-Conductive Plastic Case

Models Single output



Model	Input Voltage (V)	Output Voltage (V)	Output Current Max (mA)	Isolation (VDC)	Input Current Full Load No Load (mA)		Max Capacitive Load (uF)	Efficiency (%)
AM2D-0505S-RZ	4.5-5.5	5	400	1000	494	50	220	81
AM2D-0509S-RZ	4.5-5.5	9	222	1000	471	50	220	85
AM2D-0512S-RZ	4.5-5.5	12	166	1000	471	50	100	85
AM2D-0515S-RZ	4.5-5.5	15	133	1000	465	50	100	86
AM2D-1205S-RZ	10.8-13.2	5	400	1000	198	40	220	84
AM2D-1209S-RZ	10.8-13.2	9	222	1000	194	40	220	86
AM2D-1212S-RZ	10.8-13.2	12	166	1000	189	40	100	88
AM2D-1215S-RZ	10.8-13.2	15	133	1000	189	40	100	88
AM2D-1505S-RZ	13.5-16.5	5	400	1000	157	30	220	85
AM2D-1509S-RZ	13.5-16.5	9	222	1000	153	30	220	87
AM2D-1512S-RZ	13.5-16.5	12	166	1000	153	30	100	87
AM2D-1515S-RZ	13.5-16.5	15	133	1000	152	30	100	88
AM2D-2405S-RZ	21.6-26.4	5	400	1000	102	20	220	82
AM2D-2409S-RZ	21.6-26.4	9	222	1000	99	20	220	84
AM2D-2412S-RZ	21.6-26.4	12	166	1000	97	20	100	86
AM2D-2415S-RZ	21.6-26.4	15	133	1000	96	20	100	87
AM2D-0505SH30-RZ	4.5-5.5	5	400	3000	494	50	220	81
AM2D-0509SH30-RZ	4.5-5.5	9	222	3000	471	50	220	85
AM2D-0512SH30-RZ	4.5-5.5	12	166	3000	471	50	100	85
AM2D-0515SH30-RZ	4.5-5.5	15	133	3000	465	50	100	86
AM2D-1205SH30-RZ	10.8-13.2	5	400	3000	198	40	220	84
AM2D-1209SH30-RZ	10.8-13.2	9	222	3000	194	40	220	86
AM2D-1212SH30-RZ	10.8-13.2	12	166	3000	189	40	100	88
AM2D-1215SH30-RZ	10.8-13.2	15	133	3000	189	40	100	88
AM2D-1505SH30-RZ	13.5-16.5	5	400	3000	157	30	220	85
AM2D-1509SH30-RZ	13.5-16.5	9	222	3000	153	30	220	87
AM2D-1512SH30-RZ	13.5-16.5	12	166	3000	153	30	100	87
AM2D-1515SH30-RZ	13.5-16.5	15	133	3000	152	30	100	88
AM2D-2405SH30-RZ	21.6-26.4	5	400	3000	102	20	220	82
AM2D-2409SH30-RZ	21.6-26.4	9	222	3000	99	20	220	84
AM2D-2412SH30-RZ	21.6-26.4	12	166	3000	97	20	100	86
AM2D-2415SH30-RZ	21.6-26.4	15	133	3000	96	20	100	87

Models
Dual output

Model	Input Voltage (V)	Output Voltage (V)	Output Current Max (mA)	Isolation (VDC)	Input Current Full Load No Load (mA)		Max Capacitive Load (uF)	Efficiency (%)
AM2D-0505D-RZ	4.5-5.5	±5	±200	1000	488	50	±100	82
AM2D-0509D-RZ	4.5-5.5	±9	±111	1000	471	50	±100	85
AM2D-0512D-RZ	4.5-5.5	±12	±83	1000	465	50	±47	86
AM2D-0515D-RZ	4.5-5.5	±15	±66	1000	460	50	±47	87
AM2D-1205D-RZ	10.8-13.2	±5	±200	1000	200	40	±100	84
AM2D-1209D-RZ	10.8-13.2	±9	±111	1000	189	40	±100	88
AM2D-1212D-RZ	10.8-13.2	±12	±83	1000	187	40	±47	89
AM2D-1215D-RZ	10.8-13.2	±15	±66	1000	187	40	±47	89
AM2D-1505D-RZ	13.5-16.5	±5	±200	1000	157	30	±100	85
AM2D-1509D-RZ	13.5-16.5	±9	±111	1000	152	30	±100	88
AM2D-1512D-RZ	13.5-16.5	±12	±83	1000	152	30	±47	88
AM2D-1515D-RZ	13.5-16.5	±15	±66	1000	152	30	±47	88
AM2D-2405D-RZ	21.6-26.4	±5	±200	1000	102	20	±100	82
AM2D-2409D-RZ	21.6-26.4	±9	±111	1000	98	20	±100	85
AM2D-2412D-RZ	21.6-26.4	±12	±83	1000	97	20	±47	86
AM2D-2415D-RZ	21.6-26.4	±15	±66	1000	96	20	±47	87
AM2D-0505DH30-RZ	4.5-5.5	±5	±200	3000	488	50	±100	82
AM2D-0509DH30-RZ	4.5-5.5	±9	±111	3000	471	50	±100	85
AM2D-0512DH30-RZ	4.5-5.5	±12	±83	3000	465	50	±47	86
AM2D-0515DH30-RZ	4.5-5.5	±15	±66	3000	460	50	±47	87
AM2D-1205DH30-RZ	10.8-13.2	±5	±200	3000	200	40	±100	84
AM2D-1209DH30-RZ	10.8-13.2	±9	±111	3000	189	40	±100	88
AM2D-1212DH30-RZ	10.8-13.2	±12	±83	3000	187	40	±47	89
AM2D-1215DH30-RZ	10.8-13.2	±15	±66	3000	187	40	±47	89
AM2D-1505DH30-RZ	13.5-16.5	±5	±200	3000	157	30	±100	85
AM2D-1509DH30-RZ	13.5-16.5	±9	±111	3000	152	30	±100	88
AM2D-1512DH30-RZ	13.5-16.5	±12	±83	3000	152	30	±47	88
AM2D-1515DH30-RZ	13.5-16.5	±15	±66	3000	152	30	±47	88
AM2D-2405DH30-RZ	21.6-26.4	±5	±200	3000	102	20	±100	82
AM2D-2409DH30-RZ	21.6-26.4	±9	±111	3000	98	20	±100	85
AM2D-2412DH30-RZ	21.6-26.4	±12	±83	3000	97	20	±47	86
AM2D-2415DH30-RZ	21.6-26.4	±15	±66	3000	96	20	±47	87

NOTE: All specifications in this datasheet are measured at an ambient temperature of 25°C, humidity<75%, nominal input voltage and at rated output load unless otherwise specified.

Input Specifications

Parameters	Nominal	Typical	Maximum	Units
Voltage range	5	4.5-5.5		VDC
	12	10.8-13.2		VDC
	15	13.5-16.5		VDC
	24	21.6-26.4		VDC
Filter	Capacitor			
Absolute Maximum Rating	5 Vin		9	VDC
	12 Vin		18	VDC
	15 Vin		20	VDC
	24 Vin		30	VDC
Peak Input Voltage time			100	ms
No Load Input Current			50	mA

Isolation Specifications

Parameters	Conditions	Typical	Maximum	Units
Tested/I/O voltage	60sec		1000, 3000	VDC
Resistance		>1000		MOhm
Capacitance		60		pF

Output Specifications

Parameters	Conditions	Typical	Maximum	Units
Voltage accuracy		-4 to +2		%
Line voltage regulation	For 1.0% of Vin	±1.2		% of Vin
Load voltage regulation	Load 10~100%, 5Vin/5Vout models	6		%
	Load 10~100%, other models	5		%
Temperature coefficient		±0.02		%/°C
Ripple & Noise *	20MHz Bandwidth	50		mVp-p
Minimum Load Current **		10		% of Max

* Measured with a 1µF ceramic capacitor.

** Operating the converter below the minimum load current will not damage the converter, but the specifications may not be meet.

General Specifications

Parameters	Conditions	Typical	Maximum	Units
Switching frequency	100% load	70		KHz
Operating temperature		-40 to +85		°C
Storage temperature		-40 to +125		°C
Maximum case temperature			100	°C
Cooling	Free Air Convection			
Humidity			95	% RH
Case material	Plastic UL94V-0			
Weight		2.8		g
Dimensions (L x W x H)	0.76 x 0.28 x 0.39 inch 19.50 x 7.20 x 10.00 mm			
MTBF	>1.9 Mhrs (MIL-HDBK -217F, Ground Benign, t=+25°C)hours			
Maximum soldering temperature	1.5mm from case for 10 sec		260	°C

Safety Specifications

Parameters	
Agency Approval	CE
Standards	EN55032, Class B
	IEC61000-4-2, Criteria A
	IEC61000-4-3, Criteria A
	IEC61000-4-4, Criteria A (external 220uF/100V cap required)
	IEC61000-4-6, Criteria A
	IEC61000-4-8, Criteria A

Pin Out Specifications

Pin	1000 VDC		3000VDC	
	Single	Dual	Single	Dual
1	+ V Input	+ V Input	+ V Input	+ V Input
2	- V Input	- V Input	- V Input	- V Input
4	- V Output	- V Output	No pin	No pin
5	No pin	Common	-V Output	-V Output
6	+ V Output	+ V Output	No pin	Common
7	No pin	No pin	+V Output	+V Output

Dimensions

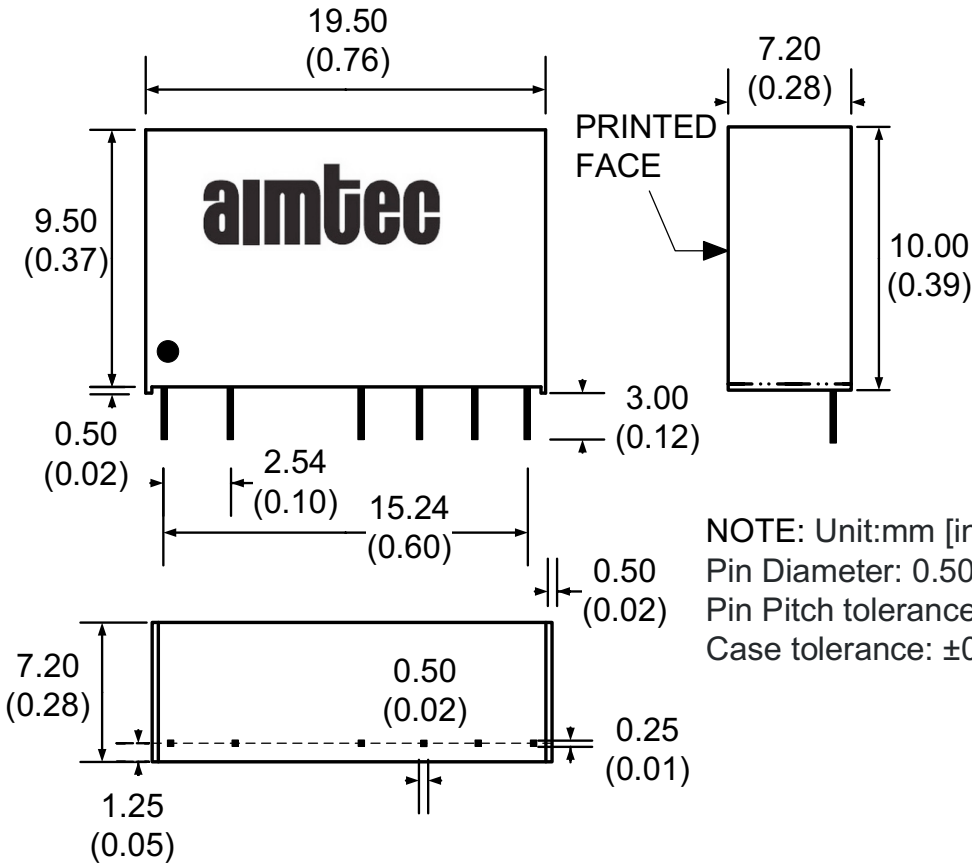

NOTE: Unit:mm [inch]
 Pin Diameter: $0.50 \pm 0.05\text{mm}$ [0.02 ± 0.002 inch]
 Pin Pitch tolerance: $\pm 0.35\text{mm}$ [± 0.014 inch]
 Case tolerance: $\pm 0.50\text{mm}$ [± 0.02 inch]

Application Circuit, & Conducted Emissions

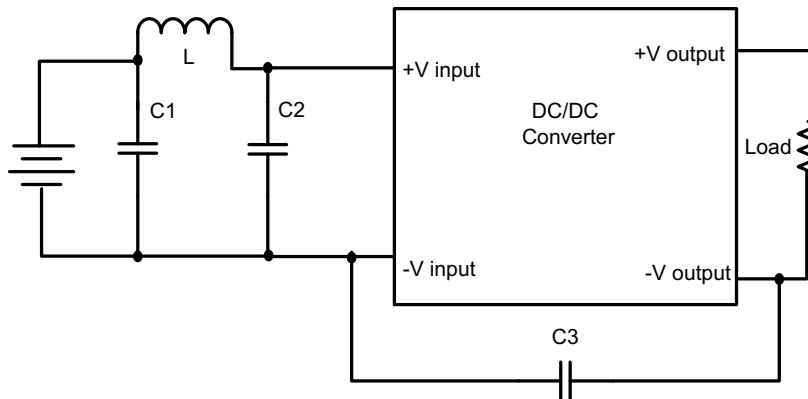

Input Voltage (VDC)	C1	L	C2	C3
5	2.2uF/100V	18uH	N/A	N/A
12	2.2uF/100V	18uH	N/A	N/A
15	2.2uF/100V	18uH	N/A	N/A
24	2.2uF/100V	18uH	2.2uF/100V	470pF/2KV

EFT

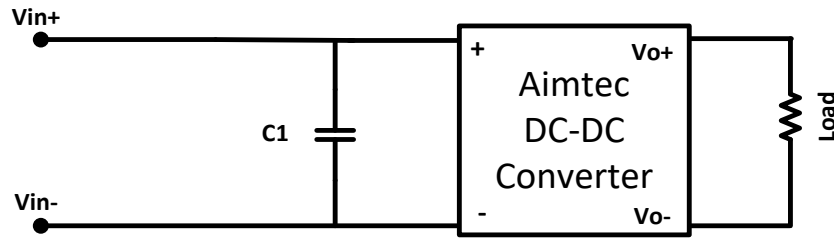

Input Voltage (VDC)	C1
5	220uF/100V
12	220uF/100V
15	220uF/100V
24	220uF/100V

Typical Efficiency Chart Examples

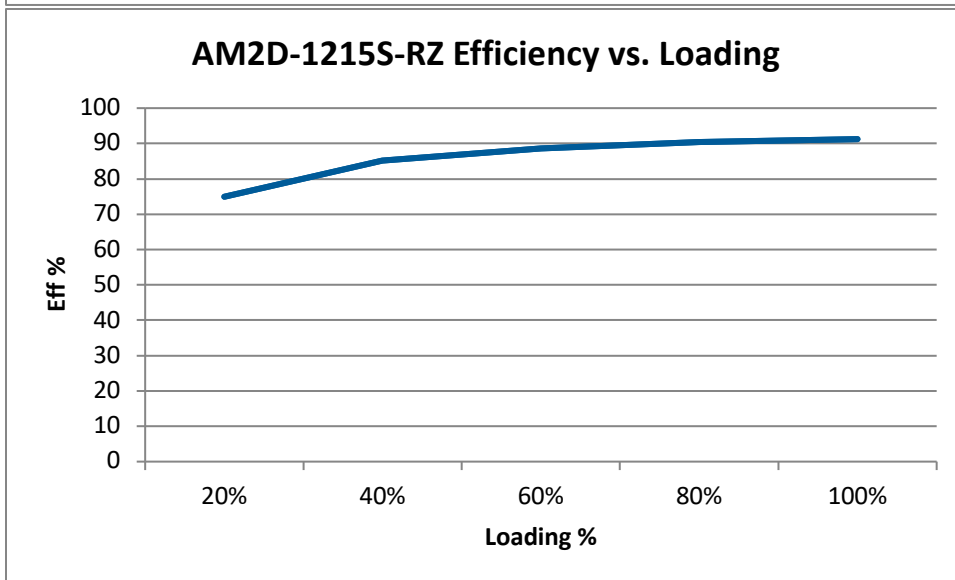
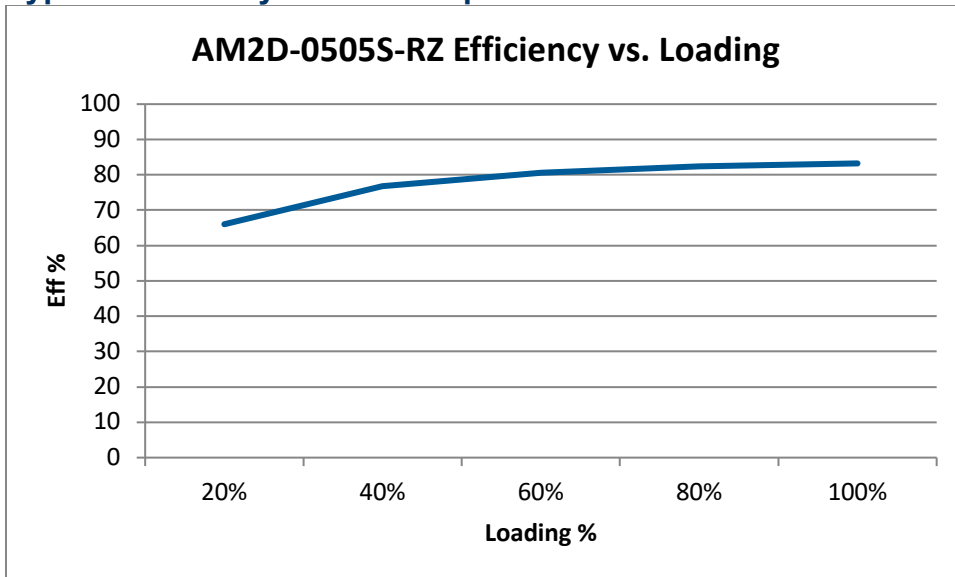

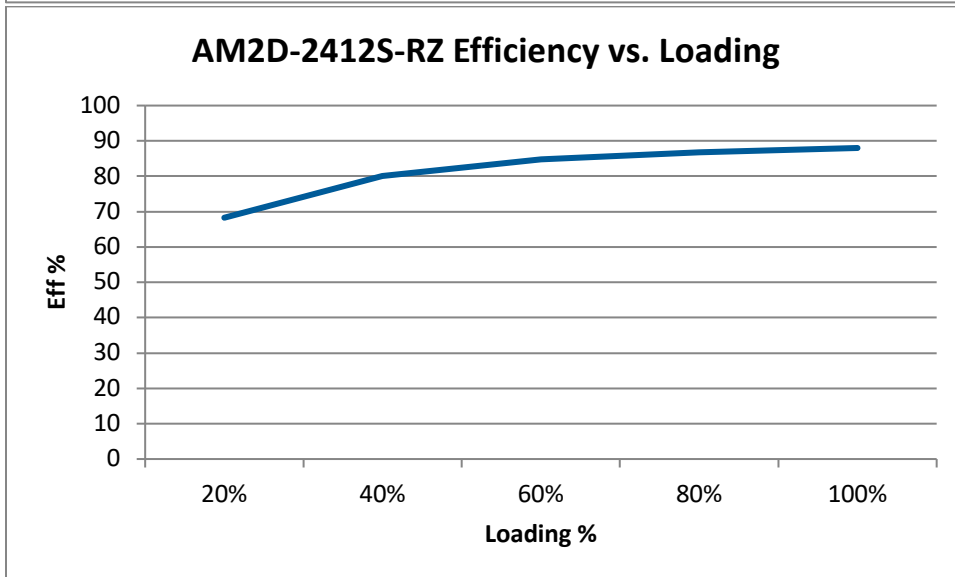
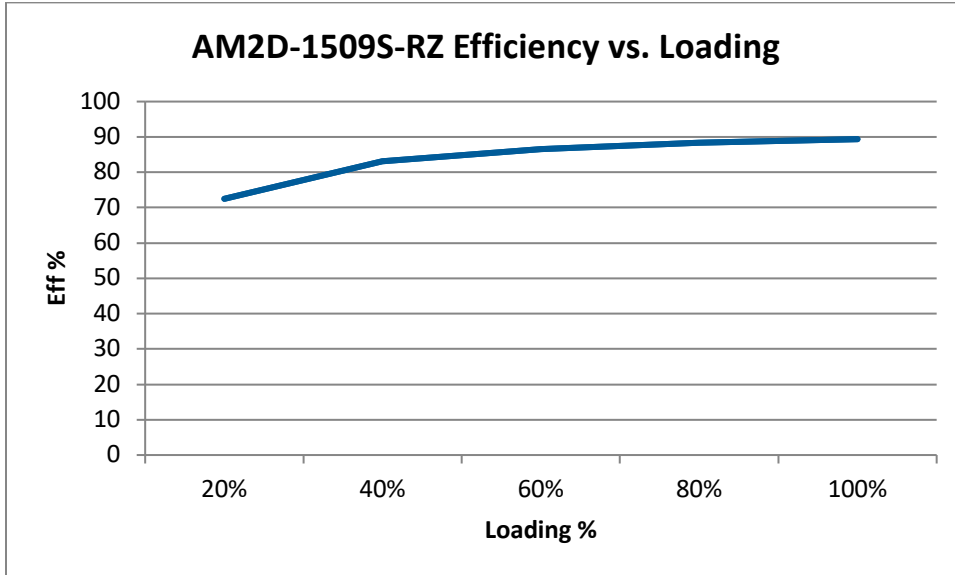

NOTE: 1. Datasheets are updated as needed and as such, specifications are subject to change without notice. Once printed or downloaded, datasheets are no longer controlled by Aimtec; refer to www.aimtec.com for the most current product specifications. 2. Product labels shown, including safety agency certifications on labels, may vary based on the date manufactured. 3. Mechanical drawings and specifications are for reference only. 4. All specifications are measured at an ambient temperature of 25°C, humidity < 75%, nominal input voltage and at rated output load unless otherwise specified. 5. Aimtec may not have conducted destructive testing or chemical analysis on all internal components and chemicals at the time of publishing this document. CAS numbers and other limited information are considered proprietary and may not be available for release. 6. This product is not designed for use in critical life support systems, equipment used in hazardous environments, nuclear control systems or other such applications which necessitate specific safety and regulatory standards other than the ones listed in this datasheet. 7. Warranty is in accordance with Aimtec's standard Terms of Sale available at www.aimtec.com.