

# 1D/1E/1F

Round caps • many color options •  
many illumination options



## DISTINCTIVE FEATURES

Round  $\varnothing 9.6$  mm

h=14.9 mm

Chamfer edges

Full, lens or legend illumination option

20 standard color options



SWITCH SPECIFICATIONS : see Multimec™ 3 series.

### 3F+1D - SMD

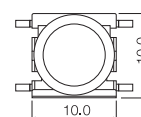
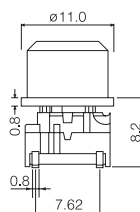
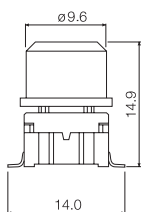

### 3F+1E - TH W/LED

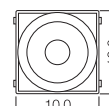
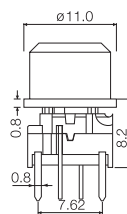
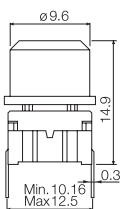

### 3F+1F - TH W/LED

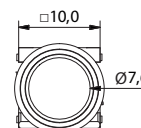
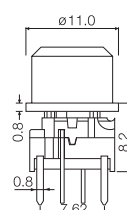
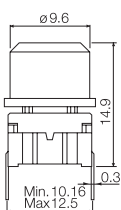

### 3F+1D WITH RAS

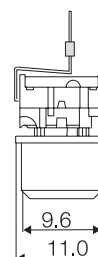
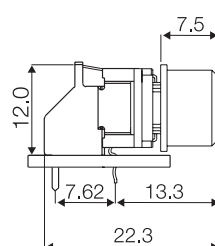
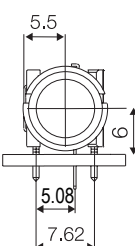

The company reserves the right to change specifications without notice. All tolerance if not otherwise specified  $\pm 0.2$ mm.

# 1D/1E/1F

Round caps • many color options • many illumination options

## BUILD YOUR PART NUMBER

### ILLUMINATED

3F

SERIES

MOUNTING

**TH9** through-hole

LED

**05** blue  
**20** green  
**40** yellow  
**65** white  
**80** red  
**2040** green/yellow  
**8020** red/green  
**8040** red/yellow

CAP

**1E**  
**1F**  
**1D**

COLOR  
1E/1F

**03** grey  
**09** black  
**1D**  
**11** transparent  
**16** frosted white

LENS 1E/1F

**1** transparent  
**2** green  
**4** yellow  
**6** frosted white  
**8** red

### NON-ILLUMINATED

3F

SERIES

MOUNTING

**TH9** through-hole  
**SH9** surface mount

1D

CAP

**00** blue  
**02** green  
**03** grey  
**04** yellow  
**06** white  
**08** red  
**09** black  
**30** ultra blue  
**32** mint green  
**33** tele grey  
**34** melon  
**38** noble red  
**40** dusty blue  
**42** aqua blue

COLOR

**50** metal dark blue  
**53** metal light grey  
**57** metal dark grey  
**58** metal bordeaux

**NOTICE** : Please note that not all combinations of above numbers are available.  
 Other versions : Please refer to [www.apem.com](http://www.apem.com) for information on the 5G series  
 versions - 1DS/1ES/1FS

## MOUNTING

- Panel cut-out : min. Ø10.0 mm
- Switch spacing AxB : min. 12.7 x 11.3 mm

## MATERIALS

- Cap :
  - solid color : ABS UL94HB
  - illuminated : polycarbonate UL94HB
- Lens : polycarbonate UL94HB



## STANDARD LEGENDS

| STANDARD LEGENDS |       |         |                       |      |             |      |      |                         |                 |
|------------------|-------|---------|-----------------------|------|-------------|------|------|-------------------------|-----------------|
| LEGEND           | 1D09_ | 1F096R_ | 1ZB09D_<br>1ZB16DLMH_ | 1ZC_ | 1Z_<br>1ZW_ | 10A_ | 10C_ | 10R_ & 10RF_<br>10RM16_ | 10Q_<br>10QM16_ |
| 0                | 000   | 000     |                       |      |             |      |      |                         |                 |
| 1                | 001   | 001     |                       |      |             |      |      |                         |                 |
| 2                | 002   | 002     |                       |      |             |      |      |                         |                 |
| 3                | 003   | 003     |                       |      |             |      |      |                         |                 |
| 4                | 004   | 004     |                       |      |             |      |      |                         |                 |
| 5                | 005   | 005     |                       |      |             |      |      |                         |                 |
| 6                | 006   | 006     |                       |      |             |      |      |                         |                 |
| 7                | 007   | 007     |                       |      |             |      |      |                         |                 |
| 8                | 008   | 008     |                       |      |             |      |      |                         |                 |
| 9                | 009   | 009     |                       |      |             |      |      |                         |                 |
| #                | 107   | 107     |                       |      |             |      |      |                         |                 |
| *                | 019   | 019     |                       |      |             |      |      |                         |                 |
| ←                | 033   |         |                       |      |             |      |      |                         |                 |
| →                | 133   |         |                       |      |             |      |      |                         |                 |
| ↑                | 034   |         |                       |      |             |      |      |                         |                 |
| ↓                | 134   |         |                       |      |             |      |      |                         |                 |
| ↙                | 135   | 135     |                       |      |             |      |      |                         |                 |
| +                |       |         |                       |      |             | 054  |      | 054                     | 054             |
| -                |       |         |                       |      |             | 059  |      | 059                     | 059             |
| ▲                |       |         | 136                   |      | 136         | 136  |      |                         |                 |
| ⏻                | 123   | 123     |                       | 123* | 123         |      | 123  | 123                     | 123             |
| ON/OFF           |       |         |                       |      |             |      |      | 017                     | 017             |
| STOP             |       |         |                       |      |             |      |      | 018                     | 018             |
| START            |       |         |                       |      |             |      |      | 031                     | 031             |
| RESET            |       |         |                       | 038  |             |      |      | 038                     | 038             |
| CANCEL           |       |         |                       |      |             |      |      | 048                     | 048             |
| ENTER            |       |         |                       |      |             |      |      | 105                     | 105             |
| ESC              |       |         |                       | 051  |             |      |      |                         |                 |
| ON               |       |         |                       |      |             | 116  |      |                         |                 |
| OFF              |       |         |                       |      |             | 117  |      |                         |                 |
| OK               |       |         |                       | 118* | 118         |      | 118  | 118                     | 118             |
| SET              |       |         |                       | 119  |             |      |      |                         |                 |
| MENU             |       |         |                       | 120  |             |      |      |                         |                 |
| FUNC             |       |         |                       | 121  |             |      |      |                         |                 |
| HOME             |       |         |                       | 122  |             |      |      |                         |                 |

### STANDARD OPTIONS

- 1D: pad printed
- 1F: reverse printed
- 1ZB: pad printed / laser marked
- 1ZC: pad printed \*reverse printed \*laser marked
- 1Z & 1ZW: pad printed / laser marked

- 10A: pad printed / laser marked
- 10C: pad printed / laser marked
- 10R(F) & 10Q: pad printed / reverse printed
- 10RM & 10QM: metal symbol

# Legends

Available for Multimec caps



## HOW TO ORDER

### POSITIONING OF LEGENDS ON ROCKER-ACTION CAPS

When ordering legends for caps with hinge-type cap retention system, it is important to note the position of the cap. An extra letter (U, D, R or L) needs to be added to the part number to refer to the position of the hinges in relation to the legend. See samples:

Rocker-action caps without a lens: 1A, 1B, 1M, 1ZA and 1ZB

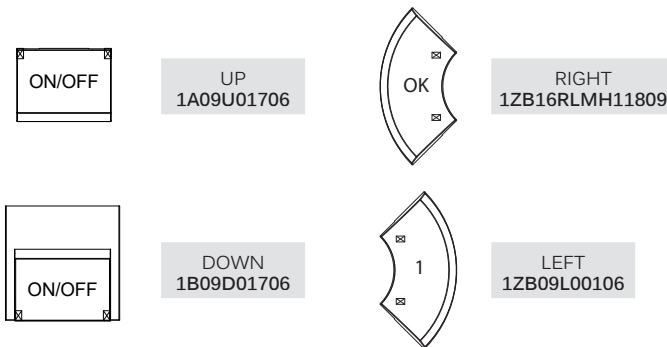

### STANDARD AND CUSTOM LEGENDS

- Standard are only certain legends on certain caps. See the table on the previous page.
- All standard pad-printed legends are white on black caps.
- All standard reverse-printed and laser marked legends are black on frosted white cap.

### STANDARD LEGENDS

| CAP | CAP COLOR        | DIRECTION*                | TYPE*                          | LEGEND | LEGEND COLOR*  |
|-----|------------------|---------------------------|--------------------------------|--------|----------------|
| 1D  | 00 Blue          | D Down                    | UV UV printed                  | 001 1  | 00 Blue        |
| 1F  | 02 Green         | U Up                      | LM Laser marked on soft paint  | 002 2  | 03 Grey        |
| ... | 03 Grey          | R Right                   | LMH Laser marked on hard paint | 003 3  | 06 White       |
|     | 04 Yellow        | L Left                    | R Reverse printed              | ...    | 08 Red         |
|     | 06 White         | *Only for hinge-type caps |                                |        | 09 Black       |
|     | 08 Red           |                           | *In case of illumination       |        | MC Multi color |
|     | 09 Black         |                           |                                |        | ... Etc        |
|     | 16 Frosted white |                           |                                |        |                |
|     | ...              |                           |                                |        |                |

\*In case of reverse printed and laser marked legends the colour of the paint

### LEGEND ILLUMINATION

- **Option 1 - laser marked:** In case of laser marked legends an "LM" is added after the cap colour, before the legend code. We recommend using hard paint (additional "H") for increased lifetime of the paint. E.g. 1ZB16DLMH13609
- **Option 2 - reverse printed:** In case of reverse printed caps an "R" is added after the cap colour, before the legend code. Especially relevant when standard legends have both negative and positive print options. E.g. 1F096R00009
- **Option 3 - metal symbol:** Only available for 10RM and 10QM (therefore the "M"). E.g. 10RM16059

### ORIENTATION OF THE SWITCH

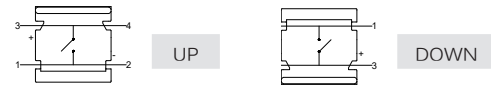







































**Notice:** The size of the legends listed may not correspond to the actual size.

If you decide to use one of the standard legends without any adjustments (without a new cliché or programming) on another cap than designated in the table, then there is no cliché or programming cost, for this to apply the cap has to be black and the print white.

For further information on legends please contact APEM.

# Solid colors

Available for Multimec caps

|          |   | Colour / RAL Code   |   |   |   |   |   |   |   |   |   |   |   |  |   |   |   |   |   |   |   |
|----------|---|---|---|---|---|---|---|---|---|---|---|---|---|--|---|---|---|---|---|---|---|
|          |   | Blue / 5012   | green / 6018  | Grey / 7004   | Yellow / 1023   | White / 9010  | Red / 3000  | Black / 9004  | Ultra blue / 5002   | Mint green / 6029   | Tele grey / 7046  | Melon / 1028  | Signal white / 9003   | Noble red / 3002   | Dusty blue / 5014   | Aqua blue / 5021  | Metal dark blue / No ral code   | Metal light grey / No ral code  | Metal dark grey / No ral code   | Metal bordeaux / No ral code  |   |
|          |   |  |  |  |  |  |  |  |  |  |  |  |  |  |  |  |  |  |  |  |   |
| CAP      | CODE  | 00  | 02  | 03  | 04  | 06  | 08  | 09  | 30  | 32  | 33  | 34  | 36  | 38   | 40  | 42  | 50  | 53  | 57  | 58  |   |
| 1A       |    | •   | •   | •   | •   | •   | •   | •   |   |   |   |   |   |  |   |   |   |   |   |   |   |
| 1B       |    | •   | •   | •   | •   | •   | •   | •   |   |   |   |   |   |  |   |   |   |   |   |   |   |
| 1D       |    | •   | •   | •   | •   | •   | •   | •   | •   | •   | •   | •   |   | •  | •   | •   | •   | •   | •   | •   | • |
| 1E/1F    |    |   |   | •   |   |   |   | •   |   |   |   |   |   |  |   |   |   |   |   |   |   |
| 1GA/1GC  |    |   |   |   |   |   |   | •   |   |   |   |   |   |  |   |   |   |   |   |   |   |
| 1H       |    |   |   | •   |   |   |   | •   |   |   |   |   |   |  |   |   |   |   |   |   |   |
| 1K       |    | •   | •   | •   | •   | •   | •   | •   |   |   |   |   |   |  |   |   |   |   |   |   |   |
| 1M       |   |   | •   | •   |   |   | •   | •   |   |   |   |   |   |  |   |   |   |   |   |   |   |
| 1N       |  |   |   | •   |   |   |   | •   |   |   |   |   |   |  |   |   |   |   |   |   |   |
| 1P       |  | •   | •   | •   | •   | •   | •   | •   |   |   |   |   |   |  |   |   |   |   |   |   |   |
| 1Q       |  | •   |   | •   |   |   |   | •   |   |   |   |   |   |  |   |   |   |   |   |   |   |
| 1R       |  |   |   | •   |   |   |   |   |   |   |   |   |   |  |   |   |   |   |   |   |   |
| 1S       |  | •   | •   | •   | •   | •   | •   | •   |   |   |   |   |   |  |   |   |   |   |   |   |   |
| 1T/1U/1V |  | •   |   | •   |   |   | •   | •   |   |   |   |   |   |  |   |   |   |   |   |   |   |
| 1WA/1WD  |  |   |   | •   |   |   |   | •   |   |   |   |   |   |  |   |   |   |   |   |   |   |
| 1X       |  |   |   | •   |   | •   |   | •   |   |   |   |   |   |  |   |   |   |   |   |   |   |
| 1ZA      |  |   |   | •   |   | •   |   | •   | •   |   |   |   |   |  | •   | •   | •   | •   | •   | •   | • |
| 1ZB      |  |   |   | •   |   | •   |   | •   | •   |   |   |   |   |  | •   | •   | •   | •   | •   | •   | • |
| 1ZC      |  |   |   | •   |   | •   | •   | •   | •   |   |   |   |   |  | •   | •   | •   | •   | •   | •   | • |
| 10A      |  |   |   | •   |   |   | •   | •   |   |   |   |   |   |  |   |   |   |   |   |   |   |
| AQC      |   |   |   |   |   |   |   | •   |   |   |   |   |   |  |   |   |   |   |   |   |   |

The RAL Codes mentioned are the codes nearest to the solid colors in the multimec™ range.

\*3E actuators and Varimec use different materials and therefor have a different color code and are not represented in this table

# Cap & Bezel Specifications

Multimec™ caps

| ACCESSORY SPECIFICATIONS |  |                          |           |
|--------------------------|--|--------------------------|-----------|
| MATERIAL                 | PARTS  | TEMP. LIMIT              | UL RATING |
| ABS                      | Solid color 1A, 1B, 1D, 1E, 1F, 1H, 1K, 1M, 1N, 1P, 1Q, 1R, 1T, 1U, 1V, 1WA, 1WD, 1X, 1ZA, 1ZB, 1ZC and AQC<br>Bezels 2C, 2D and 2K, reflectors for 1KB, 1KC, 1Y and 1YA | Max 65 °C<br>Max 149 °F  | UL94HB    |
| Polycarbonate            | All lenses and transparent colour caps, lids for 1KB & 1KC   | Max 85 °C<br>Max 185 °F  | UL94HB    |
| Polyamide                | 1GA, 1GC, 1S and 2S  | Max 160 °C<br>Max 320 °F | UL94V2    |
| Legends adhesion         | DS/EN ISO 2409 Class 1 & ASTM D3359 Class 4B   |                          |           |

# Multimec™ 3F

High performance tactile switches •  
robust



## DISTINCTIVE FEATURES

10 x 10 mm; h=10.4 mm

Illuminated RAS option

Slip-on cap retention system - great for custom caps



## ENVIRONMENTAL SPECIFICATIONS

- Sealing : IP67 according to IEC 60529
- Working and storage temperature :
  - non-illuminated : -40 °C/+160 °C (-40 °F to +320 °F)
  - illuminated : -40 °C /+85 °C (-40 °F to +185 °F)
- Soldering :
  - through-hole : IEC 60068-2-20 8
  - surface mount : JEDEC J-STD-020E



## ELECTRICAL SPECIFICATIONS

- Recommended load :
  - Gold contacts : 0.5µ-50 mA 24 VDC
  - Silver contacts : 0.5-50 mA 24 VDC
- Contact resistance : <30 mΩ - typically 10 mΩ
- Insulation resistance : >10 MΩ
- Contact bounce : <2 mS - typically 0.5 mS



## MECHANICAL SPECIFICATIONS

- Standard actuation force : 3.5 N
- Max. actuation force : 100 N for 10 sec
- Travel : 1 mm
- Lifetime : >10,000,000 cycles

The company reserves the right to change specifications without notice.

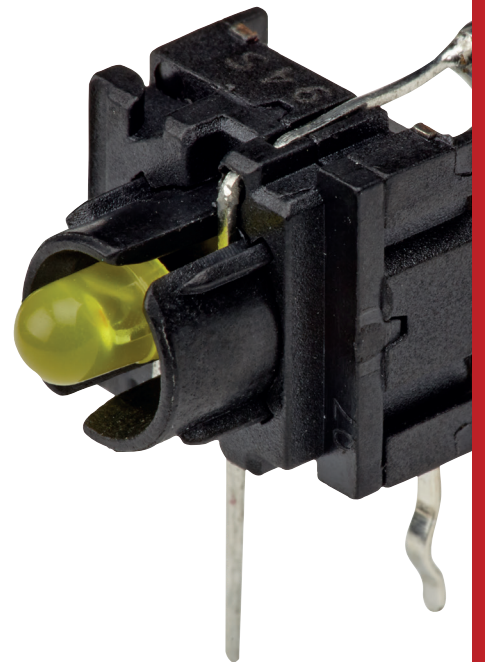

## MATERIALS

- Housing : PPS UL94V0
- Actuator : PPS UL94V0
- Sealing : Silicone rubber
- Contacts spring : Stainless steel
  - Silver : +3 µAg
  - Gold : +1 µAu
- Fixed contacts :
  - Silver : SnCu + 2 µNI + 3 µAg
  - Gold : SnCu + 2 µNI + 1 µAu
- Terminals : SnCu + 2 µNI + 3 µSn100

All tolerance if not otherwise specified ±0.2 mm.

# Multimec™ 3F

High performance tactile switches • robust

## 3F - SMD

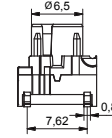
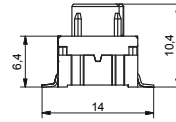
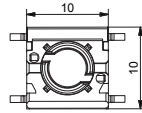

## 3F - TH

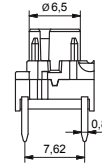
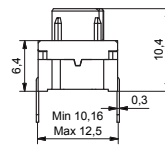
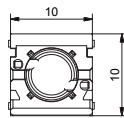

## 3F - TH W/LED

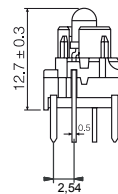
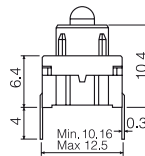
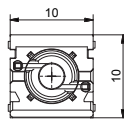

## 3F - RAS

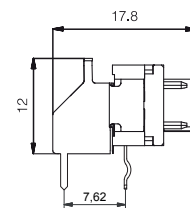
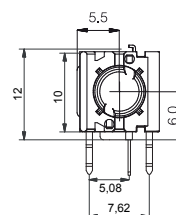
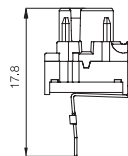



High performance tactile switches • robust

## 3F - RAS W/LED

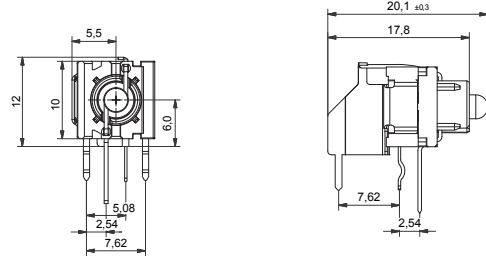
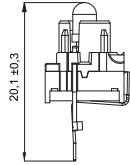

## PCB LAYOUT & CIRCUIT DIAGRAM

TH Non-ill.

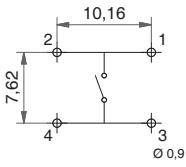

SMD non-ill.

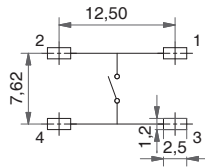

TH illuminated

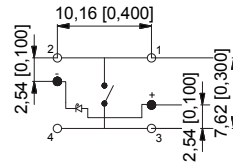

TH bi-color illuminated

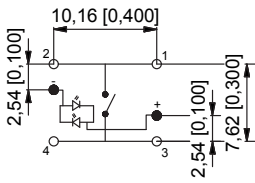

RAS

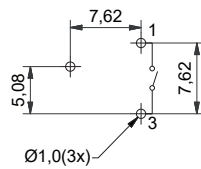

RAS illuminated

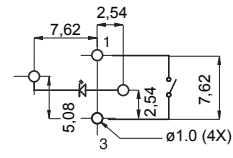

RAS bi-color illuminated

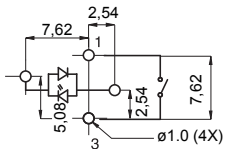

# Multimec™ 3F

High performance tactile switches • robust

## BUILD YOUR PART NUMBER

### ILLUMINATED

3F

SERIES

MOUNTING

|     |              |
|-----|--------------|
| TH9 | through-hole |
|-----|--------------|

LED

|      |                       |
|------|-----------------------|
| 06   | blue                  |
| 20   | green                 |
| 40   | yellow                |
| 65   | white                 |
| 80   | red                   |
| 2040 | green/yellow          |
| 8020 | red/green             |
| 8040 | red/yellow            |
| 24   | high intensity green  |
| 46   | high intensity yellow |
| 87   | high intensity red    |

OPTIONAL

|     |               |
|-----|---------------|
| Q   | quiet contact |
| G   | gold contacts |
| RAS | right angle   |

### NON-ILLUMINATED

3F

SERIES

MOUNTING

|     |               |
|-----|---------------|
| TH9 | through-hole  |
| SH9 | surface mount |

OPTIONAL

|     |                                |
|-----|--------------------------------|
| Q   | quiet contact                  |
| RAS | right angle<br>(with TH only)  |
| R   | tape & reel<br>(with SMD only) |
| G   | gold contacts                  |

## ABOUT THIS SERIES

 Caps and accessories : for the full range of accessories for Multimec™ 3F please see the website.

# Multimec™ 3F

High performance tactile switches • robust



## TAPE & REEL

Tape and reel is available for the parts listed and has the following specifications

- Reel diameter: Ø330 mm
- Tape width: 24 mm
- Pitch: see list
- Tape and reel material: antistatic or better
- Quantity per reel: see list

| PART NO. | ORDERING CODE | PITCH | QUANTITY PER REEL |
|----------|---------------|-------|-------------------|
| 3FSH9    | 3FSH9R        | 20    | 250               |



## OPERATING FORCE

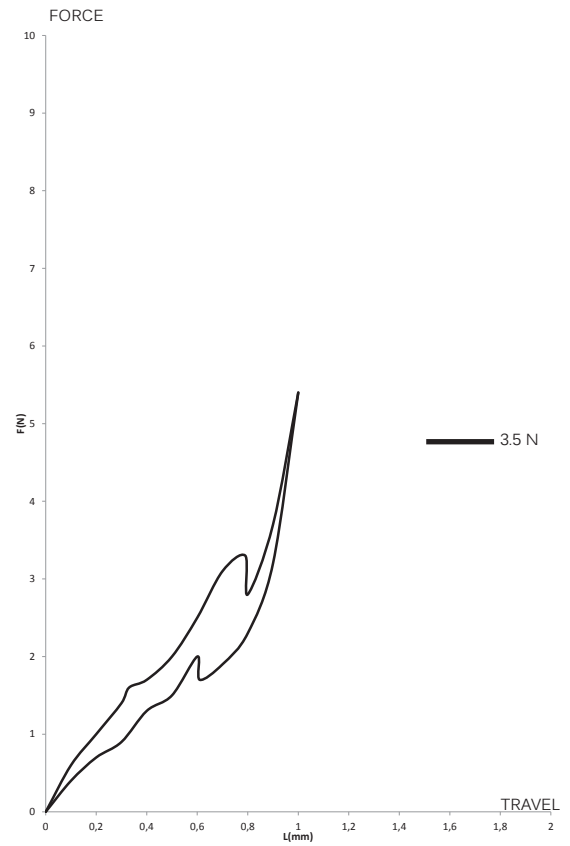

## MOUNTING

MOUNTING TOOLS FOR MULTIMEC™ THROUGH-HOLE SWITCHES

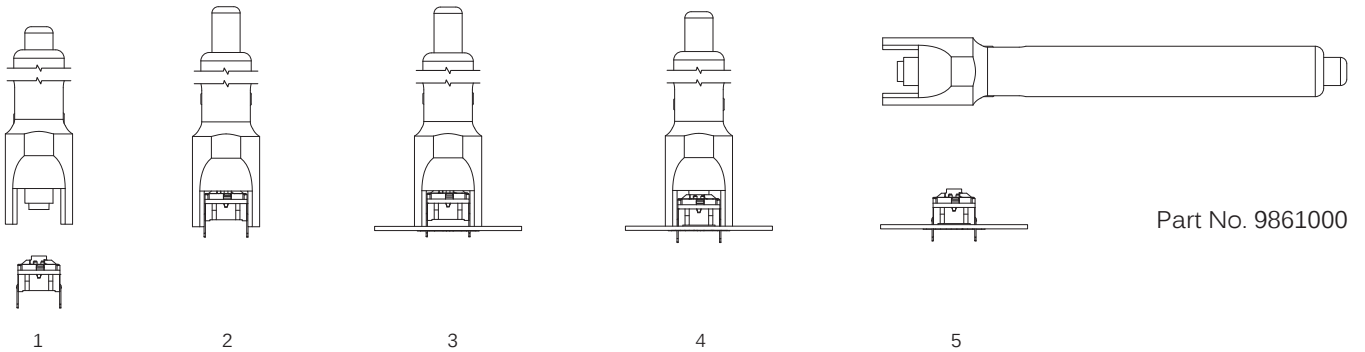

# Multimec™ 3F

High performance tactile switches •  
robust



## MOUNTING (CONTINUED)

### SPACE REQUIREMENT - MATRIX MOUNTING

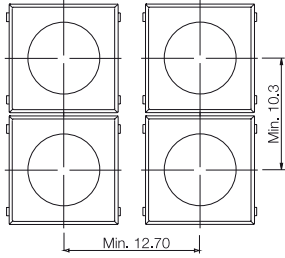

Through-hole (TH)

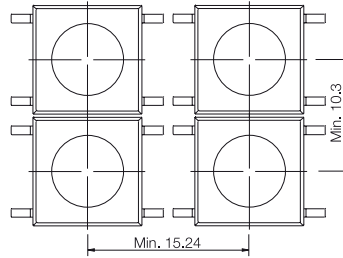

Surface mount (SMD)

### MULTIMEC™ SPACING EXAMPLES

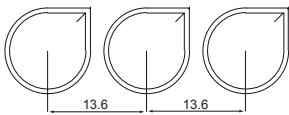

1N+1N+1N

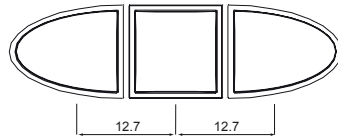

1V+1T+1V

### SPACE REQUIREMENT - SWITCH/CAP

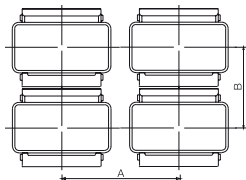

Switch spacing

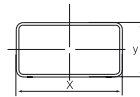

Cap dimensions

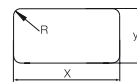

Panel cut-out

| CAP SERIES | RECOMMENDED<br>MIN.SWITCH SPACING AxB | NOMINAL CAP DIMENSION<br>WxH | RECOMMENDED<br>MIN. PANEL CUT-CUT |
|------------|---------------------------------------|------------------------------|-----------------------------------|
| 1D/1E/1F   | 12.7x11.3                             | Ø9.6                         | Ø10.0                             |
| 1GA        | 12.7x11.3                             | Ø11.0                        | Ø11.4                             |
| 1GC        | 15.3x15.3                             | Ø15.0                        | Ø15.4                             |
| 1K/1KB/1KC | 14.6x14.6                             | 14.3x14.3                    | 14.7x14.7                         |
| 1N         | 13.6x11.3                             | Ø9.8/ □4.9                   | Ø10.2/□5.1                        |
| 1P/ 1Q/1R  | 12.8x10.3                             | 6.5x12.5                     | 7.0x13.0, R max. 1.0              |
| 1S         | 12.7x10.3                             | Ø6.5                         | Ø7.0                              |
| 1T         | 12.7x12.3                             | 10.6x10.6                    | 11.0x11.0                         |
| 1U         | 12.7x12.3                             | Ø10.6                        | Ø11.0                             |
| 1V         | 15.95x12.1                            | 10.6x13.25                   | 11.0x13.65                        |
| 1WA        | 14.2x10.3                             | 12.5x6.5                     | 12.9x6.9                          |
| 1WD        | 16.9x10.3                             | 15.2x8.0                     | 15.6x8.4                          |
| 1X         | 12.7x10.3                             | 9.4x7.4                      | 9.8x7.9                           |
| 1ZC        | 14.6x14.6                             | Ø14.3                        | Ø14.7                             |



## LED COMPONENT SPECIFICATIONS

| LED COMPONENT SPECIFICATIONS                 |   |                   |          |      |          |          |                   |          |         |                   |          |          |
|--|---|-------------------|----------|------|----------|----------|-------------------|----------|---------|-------------------|----------|----------|
| Color  |   | B                 | G        | Y    | W        | R        | G/Y               | R/G      | R/Y     | G                 | Y        | R        |
| Color Codes                                  |   | 06                | 20       | 40   | 65       | 80       | 2040              | 8020     | 8040    | 24                | 46       | 87       |
| ABSOLUTE MAXIMUM RATINGS (Ta=25°C)           |   |                   |          |      |          |          |                   |          |         |                   |          |          |
| Power  | mW  | 120               | 120      | 60   | 110      | 100      | 100/60            | 100/100  | 75/75   | 60                | 60       | 60       |
| Current forward                              | mA  | 30                | 30       | 20   | 30       | 30       | 30/20             | 30/30    | 30/30   | 25                | 25       | 25       |
| Forward peak current                         | mA  | 150               | 90**     | 80** | 100      | 90**     | 120/80            | 120/120  | 160/140 | 60                | 60       | 60       |
| Voltage reverse                              | V   | 5                 | 3        | 5    | 5        | 3        | 5                 | 5        | 5       | 5                 | 5        | 5        |
| Operating temperature                        | °C  | -40/+85           | -55/+100 |      | -40/+85  | -55/+100 | -55/+100          | -55/+100 | -40/+85 | -40/+85           | -40/+85  | -40/+85  |
| Storage temperature                          | °C  | -40/+85           | -55/+100 |      | -40/+100 | -55/+100 | -55/+100          | -55/+100 | -40/+85 | -40/+100          | -40/+100 | -40/+100 |
| Soldering temperature                        | °C  | 260 for max 3 sec |          |      |          |          | 260 for max 2 sec |          |         | 260 for max 5 sec |          |          |
| ELECTRICAL-OPTICAL CHARACTERISTICS (Ta=25°C) |   |                   |          |      |          |          |                   |          |         |                   |          |          |
| Voltage forward                              | Typ. V  | 3.3               | 2.1      | 2.1  | 3.0      | 2.0      | 2.1/2.1           | 2.0/2.1  | 2/2.1   | 2.0*              | 2.0      | 2.0***   |
|  | Max. V  | 4.0               | 2.6      | 2.6  | 4.0      | 2.6      | 2.6/2.4           | 2.6/2.6  | 2.5/2.5 | 2.4*              | 2.4      | 2.4***   |
| Current reverse (VR=5V)                      | µA  | Max. 50           | 100      | 100  | 100      | 100      | 100               | 100      | 2       | 10                | 10       | 10       |
| Wave length                                  | nm  | 460               | 569      | 588  | NA       | 625      | 565               | 621/569  | 617/588 | 573               | 589      | 624      |
| Spread                                       | Δnm   | 25                | 40       | 35   | NA       | 40       | 30/35             | 40/30    | 45/35   | 20                | NA       | 20       |
| Spread angle                                 | degree  | 30                | 60       | 60   | 25       | 60       | 80/60             | 200      | 60      | 100               | 40       | 40       |
| Luminous Intensity                           | Min. mcd  | 900               | 5.6      | 1.7  | 715      | 2.5      | 3.7/2.5           | 2.2/2.2  | 6/4     | 10                | 630      | 400      |
|  | Typ. mcd  | 1600              | 12.6     | 5.6  | max 2850 | 8.7      | 12.6/8.7          | 4.8/4.8  | 14/8    | 20                | 1250     | 800      |
| Orientation                                  | The longer pin is the anode, the shorter is the cathode.<br>For bi-color LEDs the anode for the first color (ex. 8020) is the longer pin. |                   |          |      |          |          |                   |          |         |                   |          |          |

\*/F=20mA, \*\*1/10 duty cycles 0.1ms pulse width, \*\*\*/F=50mA, \*\*\*\*Luminous Flux mlm

# Multimec™ 3F

High performance tactile switches •  
robust



## USAGE GUIDELINES

### HOW TO GET THE BEST RESULTS WITH MEC SWITCHES ?

These guidelines are offered to users of MEC Switches as an aid to ensure successful and reliable switch operation. Please see the technical specifications for details on operating and storage temperatures and soldering guidelines to make sure you select the best switch for your application. When reflow soldering is taking place, MEC strongly recommend that the temperature profile is analyzed and compared with the temperature rating of the switch. It is also important to monitor the accumulated heat buildup from both the pre-heat zones and the solder zone.

Most standard accessories for multimec™ 3 series switches are made from ABS plastic with a maximum operating temperature of 65 °C. It is strongly recommended that accessories are mounted after soldering of the switch. If this is not possible care must be taken not to overheat the accessories during the soldering process. The 1S and 1GA/1GC caps are, however, made of high temperature materials and will meet the same temperature specifications as the switches. For accessories made from other plastic materials please see multimec™ 3 cap & bezel technical specifications.

LEDs have their own temperature specifications. When fitted in a 3F switch the LED will determine the max. operating temperature, i.e. 3FTH924 has an upper temperature limit of 85 °C!

### MOUNTING AND DISMOUNTING

If switches are to be mounted in rows it is essential that the recommendations regarding spacing are followed. PC board thickness should be 1.4 ±0.2 mm and terminal hole diameter should be 0.9 mm.

All multimec™ caps and bezels are easily slid onto the switch modules and can be changed at a later time .

Care must be taken when inserting the 3FT switch and LED assembly into the PC board. Do not press direct on the LED. This will force the LED down into the actuator and risks to cause the switch contacts to remain in the closed position. To correct the fault, the LED must be raised slightly and centered in the actuator to assure unrestricted movement of the actuator.

A mounting tool is available for through hole multimec™ 3 series switches.

### SOLDERING AND CLEANING MULTIMEC™ 3 SERIES

Multimec™ 3 series switches are fully sealed to IP67 specifications to prevent solder flux and aqueous based cleaning solutions from entering the switch and contaminating the contacts. The switches can be placed on the PC board with other components and reflow soldered. Multimec™ 3 series

offers a high level of sealing, however, with aqueous solvent solutions care must be taken to avoid the worst case situation with water jets, complete immersion into a liquid with a temperature below the board or surface tension reducing additives.

Recommended cleaning methods are demineralized water. Any surface tension reducing agents, such as soap, must not be used as they risk causing a potential leakage of the switch.

### SOLDERING - THROUGH HOLE VERSIONS

**Hand soldering:** max. 350 °C for max. 3 sec

**Wave soldering:** heat built up in the switch during pre-heating and soldering must not exceed the maximum operating temperature of the switch. Peak temperature must not exceed 260 °C, and soldering time is max 10 sec. (IEC 60068-2-20 8)

### SOLDERING - SURFACE MOUNT VERSIONS

For all methods - infrared, convection and vapor phase. The upper limit 240 °C/40 sec must be observed. The soldering temperature profile must have moderate temperature gradients. (JEDEC J-STD-020E)

### ROHS COMPLIANCE

As of 1 July 2006 MEC has completed the conversion to RoHS compliance. For more info please see our homepage [www.apem.com](http://www.apem.com)

### TEMPERATURE LIMITS

|             |              |
|-------------|--------------|
| Switch      | 160 °C       |
| LEDs        | 80/85/100 °C |
| Accessories | 65/85/160 °C |

### PACKAGING

Multimec™ 3 series switches are packed in rigid tubes of 50 pieces each.

A box contains 1.000 pcs.

The surface mount versions of multimec™ 3 series switches with a height up to 12.5 mm can also be delivered on tape/reel.

Each reel contains 250/500 pcs.

Right angle switches are packed in trays.  
A tray contains 100 pcs.