

150 V, 2 A power Schottky rectifier

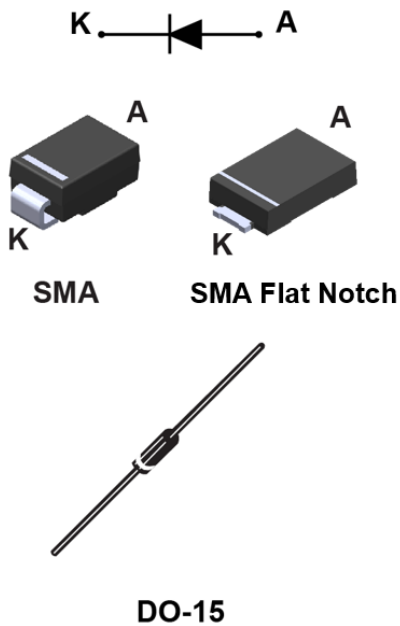

Features

- Negligible switching losses
- Low forward voltage drop for higher efficiency and extended battery life
- Low thermal resistance
- Surface mount miniature package
- Avalanche capability specified
- [ECOPACK2](#) compliant

Applications

- Switching diode
- SMPS
- DC/DC converter
- Telecom power

Description

This 150 V power Schottky rectifier is ideal for switch mode power supplies on up to 24 V rails and high frequency converters.

Packaged in SMA, SMA Flat Notch and axial, the [STPS2150](#) is optimized for use in consumer and computer applications where low drop forward voltage is required to reduce power dissipation.

Product status link	
STPS2150	
Product status link	
Symbol	Values
$I_{F(AV)}$	2 A
V_{RRM}	150 V
$T_j(max.)$	175 °C
$V_F(typ.)$	0.62 V

1 Characteristics

Table 1. Absolute ratings (limiting values, at 25 °C, unless otherwise specified)

Symbol	Parameter		Value	Unit	
V_{RRM}	Repetitive peak reverse voltage		150	V	
$I_{F(RMS)}$	Forward rms current		30	A	
$I_{F(AV)}$	Average forward current $\delta = 0.5$, square wave	SMA	$T_L = 145\text{ °C}$	2	A
		SMA Flat Notch	$T_L = 145\text{ °C}$		
		DO-15	$T_L = 130\text{ °C}$		
I_{FSM}	Surge non repetitive forward current	SMA	$t_p = 10\text{ ms sinusoidal}$	75	A
		SMA Flat Notch		70	
		DO-15		150	
P_{ARM}	Repetitive peak avalanche power	$t_p = 10\text{ }\mu\text{s}, T_j = 125\text{ °C}$	170	W	
T_{stg}	Storage temperature range		-65 to + 175	°C	
T_j	Maximum operating junction temperature ⁽¹⁾		+ 175	°C	

1. $(dP_{tot}/dT_j) < (1/R_{th(j-a)})$ condition to avoid thermal runaway for a diode on its own heatsink.

Table 2. Thermal resistance parameter

Symbol	Parameter		Value	Unit	
$R_{th(j-L)}$	Junction to lead		SMA	20	°C/W
			SMA Flat Notch	20	
	Junction to lead	Lead length = 10 mm	DO-15	30	

For more information, please refer to the following application note :

- AN5088 : Rectifiers thermal management, handling and mounting recommendations

Table 3. Static electrical characteristics

Symbol	Parameter	Test conditions		Min.	Typ.	Max.	Unit
$I_R^{(1)}$	Reverse leakage current	$T_j = 25\text{ °C}$	$V_R = V_{RRM}$	-	0.5	1.5	μA
		$T_j = 125\text{ °C}$		-	0.5	1.5	mA
$V_F^{(2)}$	Forward voltage drop	$T_j = 25\text{ °C}$	$I_F = 2\text{ A}$	-	0.78	0.82	V
		$T_j = 125\text{ °C}$		-	0.62	0.67	
		$T_j = 25\text{ °C}$	$I_F = 4\text{ A}$	-	0.86	0.89	
		$T_j = 125\text{ °C}$		-	0.70	0.75	

1. Pulse test: $t_p = 5\text{ ms}, \delta < 2\%$

2. Pulse test: $t_p = 380\text{ }\mu\text{s}, \delta < 2\%$

To evaluate the conduction losses use the following equation: $P = 0.59 \times I_{F(AV)} + 0.04 I_{F(RMS)}^2$

For more information, please refer to the following application notes related to the power losses :

- AN604: Calculation of conduction losses in a power rectifier
- AN4021: Calculation of reverse losses on a power diode

1.1 Characteristics (curves)

Figure 1. Average forward power dissipation versus average forward current

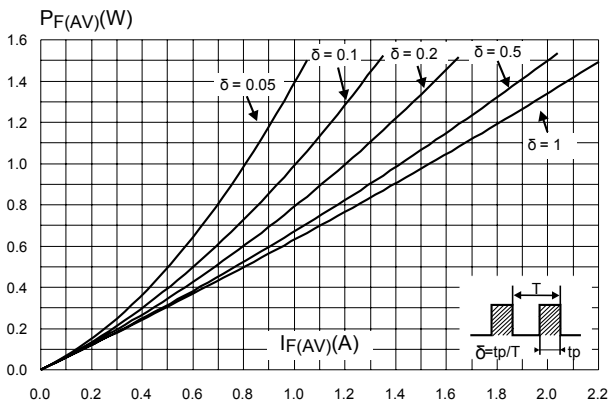

Figure 2. Average forward current versus ambient temperature ($\delta = 0.5$)

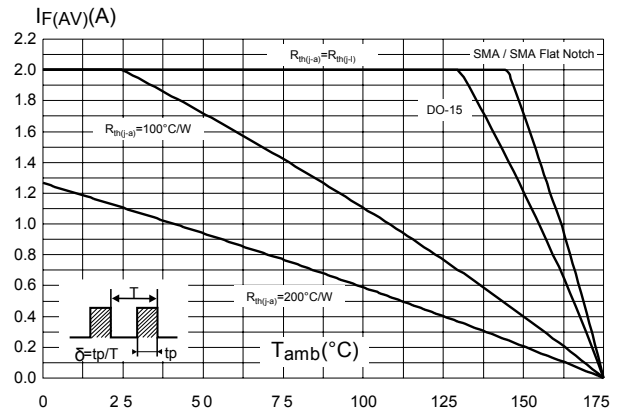

Figure 3. Normalized avalanche power derating versus pulse duration ($T_j = 125^\circ\text{C}$)

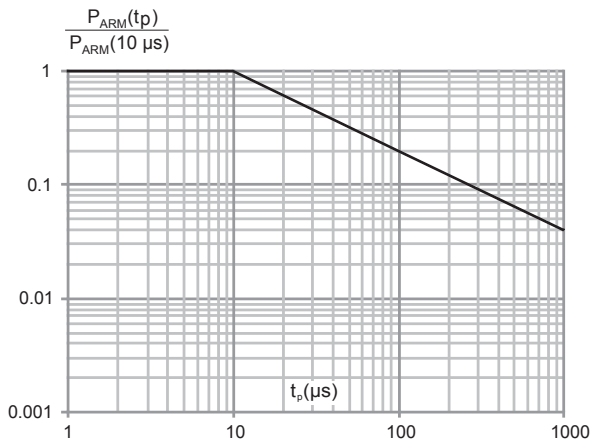

Figure 4. Relative variation of thermal impedance junction to ambient versus pulse duration (DO-15)

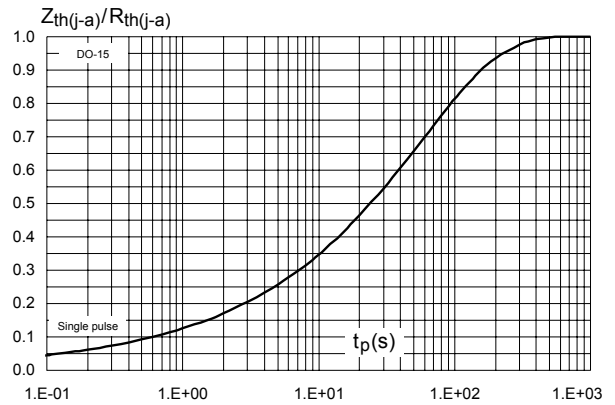

Figure 5. Relative variation of thermal impedance junction to ambient versus pulse duration (SMA)

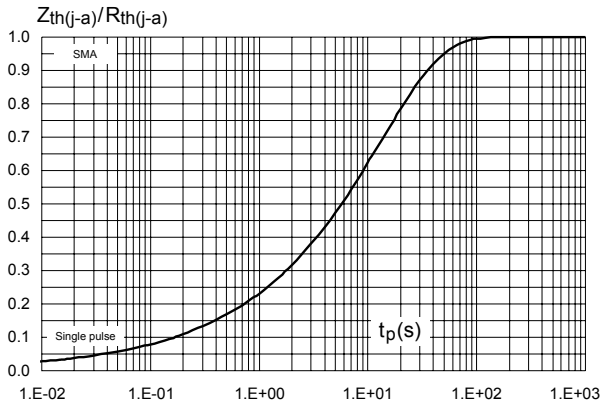

Figure 6. Reverse leakage current versus reverse voltage applied (typical values)

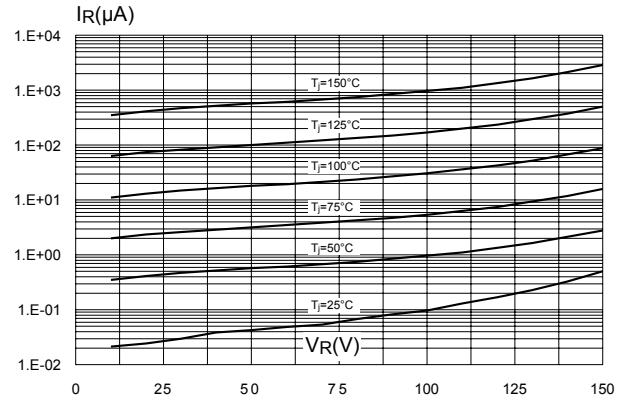

Figure 7. Junction capacitance versus reverse voltage applied (typical values)

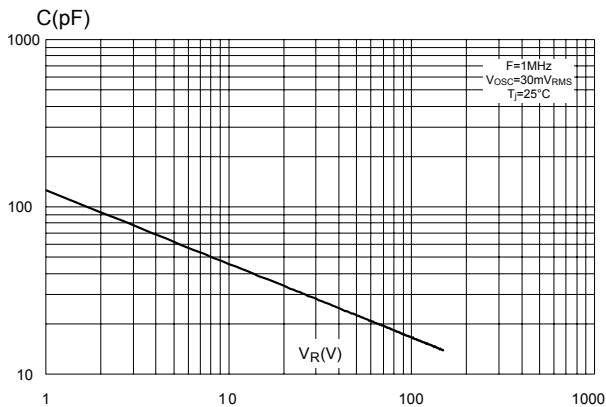

Figure 8. Forward voltage drop versus forward current (low level)

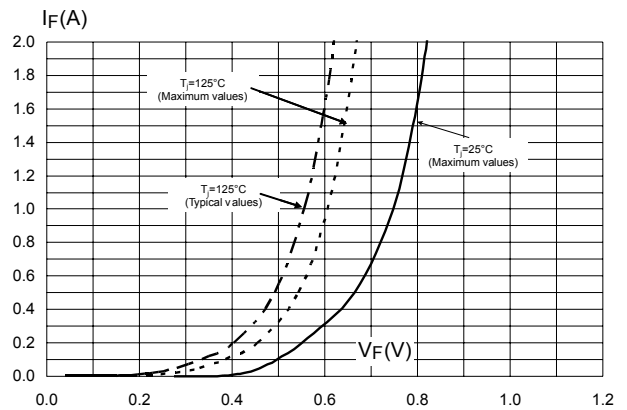

Figure 9. Forward voltage drop versus forward current (high level)

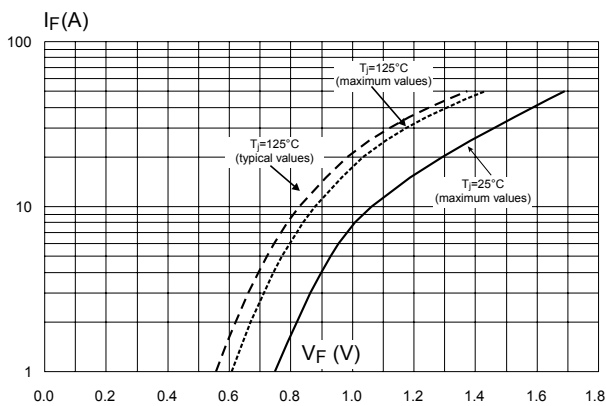

Figure 10. Thermal resistance junction to ambient versus copper surface under each lead (SMA)

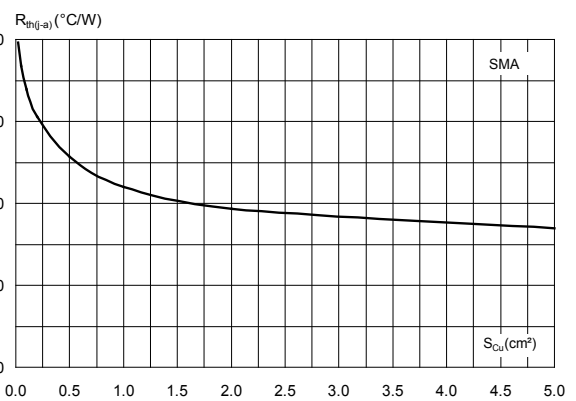

Figure 11. Thermal resistance junction to ambient versus copper surface under each lead (SMA Flat Notch)

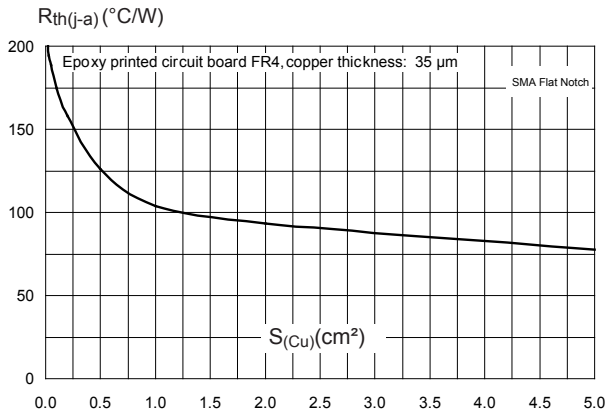
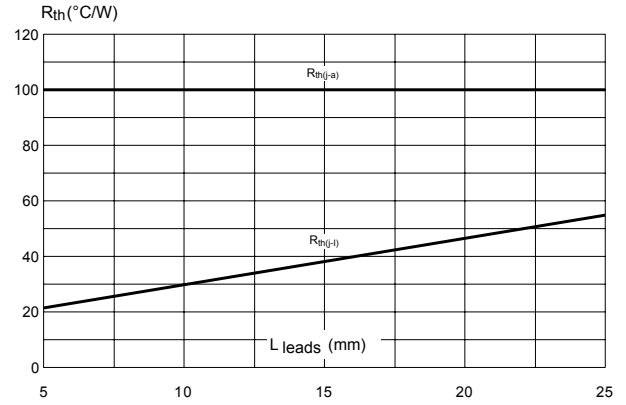

Figure 12. Thermal resistance versus lead length (DO-15)



2 Package information

In order to meet environmental requirements, ST offers these devices in different grades of **ECOPACK** packages, depending on their level of environmental compliance. ECOPACK specifications, grade definitions and product status are available at: www.st.com. ECOPACK is an ST trademark.

2.1 SMA package information

- Epoxy meets UL 94, V0
- Cooling method : by conduction (C)

Figure 13. SMA package outline

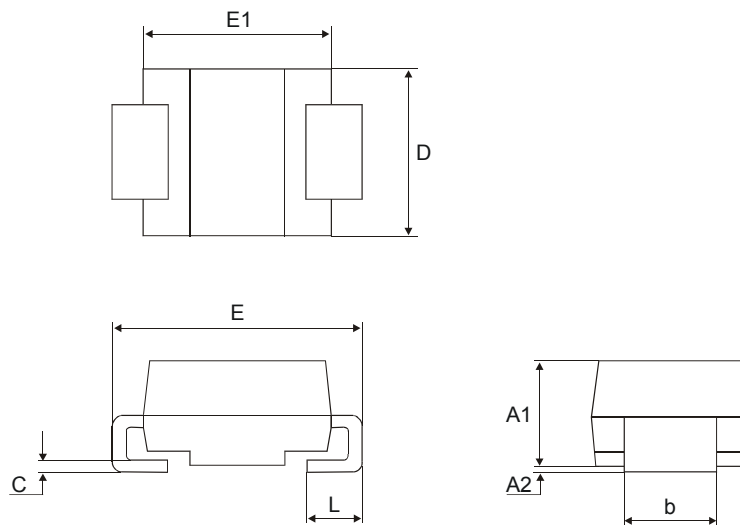
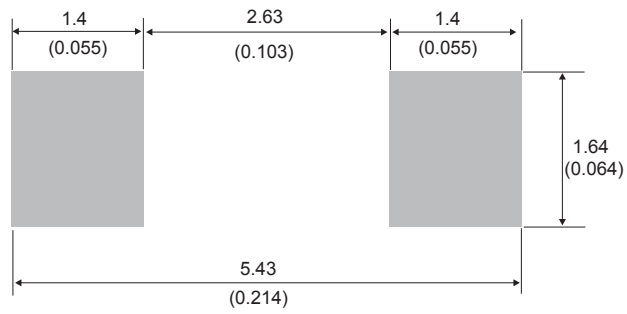

Table 4. SMA package mechanical data

Ref.	Dimensions					
	Millimeters			Inches (for reference only)		
	Min.	Typ.	Max.	Min.	Typ.	Max.
A1	1.90	-	2.45	0.075	-	0.097
A2	0.05	-	0.20	0.002	-	0.008
b	1.25	-	1.65	0.049	-	0.065
C	0.15	-	0.40	0.006	-	0.016
D	2.25	-	2.90	0.089	-	0.114
E	4.80	-	5.35	0.189	-	0.211
E1	3.95	-	4.60	0.156	-	0.181
L	0.75	-	1.50	0.030	-	0.059

Figure 14. SMA recommended footprint in mm (inches)



2.2 SMA Flat Notch package information

- Epoxy meets UL94, V0
- Cooling method: by conduction (C)
- Band indicates cathode

Figure 15. SMA Flat Notch package outline

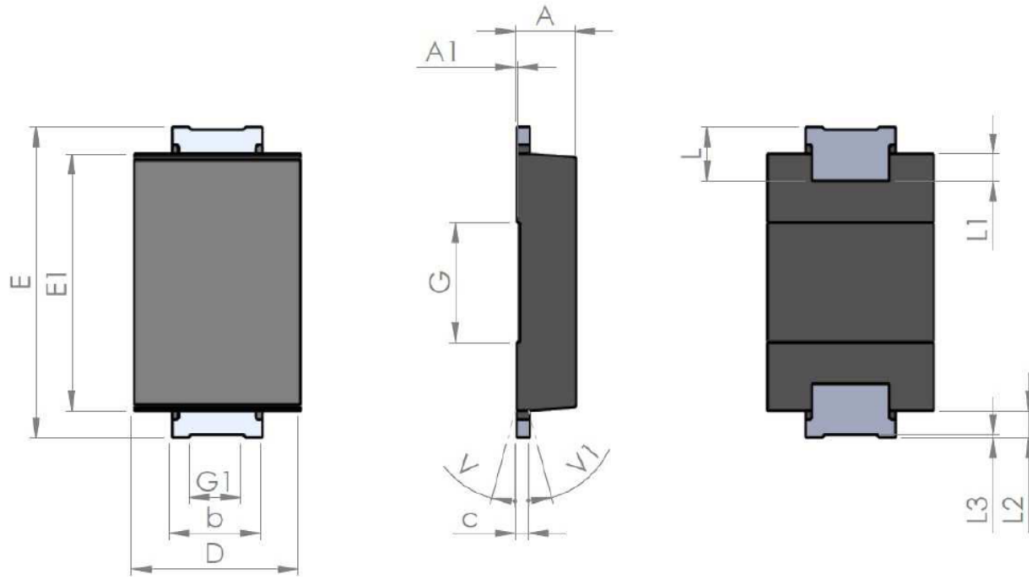
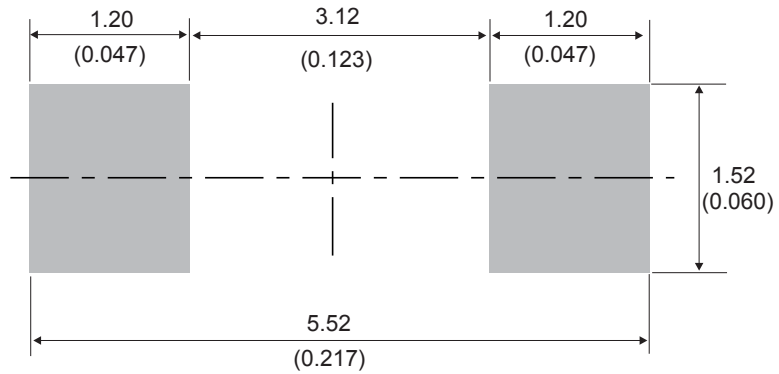

Table 5. SMA Flat Notch package mechanical data

Ref.	Dimensions					
	Millimeters			Inches (for reference only)		
	Min.	Typ.	Max.	Min.	Typ.	Max.
A1	0.90		1.10	0.035		0.044
A1		0.05			0.002	
b	1.25		1.65	0.049		0.065
C	0.15		0.40	0.005		0.016
D	2.25		2.90	0.088		0.115
E	5.00		5.35	0.196		0.211
E1	3.95		4.60	0.155		0.182
G		2.00			0.079	
G1		0.85			0.033	
L	0.75		1.20	0.029		
L1		0.45			0.018	
L2		0.45			0.018	
L3		0.05			0.002	
V			8°			8°
V1			8°			8°

Figure 16. SMA Flat Notch recommended footprint in mm (inches)



2.3 DO-15 package information

- Epoxy meets UL 94, V0

Figure 17. DO-15 package outline

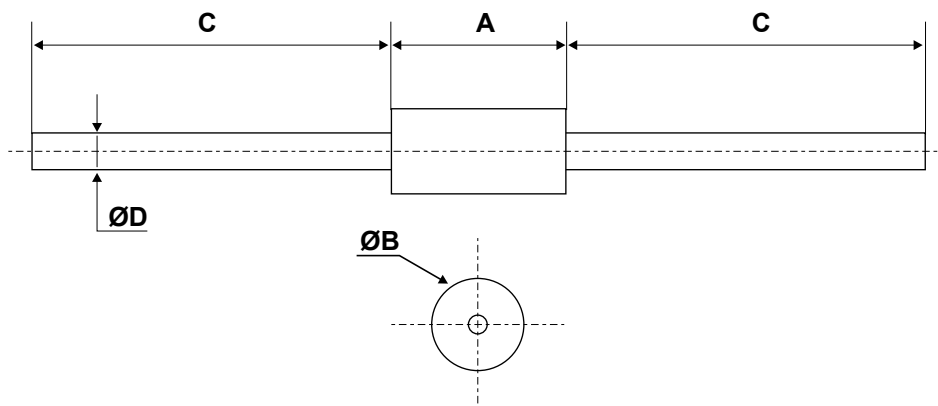

Table 6. DO-15 package mechanical data

Ref.	Dimensions					
	Millimeters			Inches (for reference only)		
	Min.	Typ.	Max.	Min.	Typ.	Max.
A	6.05	-	6.75	0.238	-	0.266
B	2.95	-	3.53	0.116	-	0.139
C	26.00	-	31.00	1.024	-	1.220
D	0.71	-	0.88	0.028	-	0.0035

3 Ordering information

Table 7. Ordering information

Order code	Marking	Package	Weight	Base qty.	Delivery mode
STPS2150AFN	A2150	SMA Flat Notch	0.039 g	10 000	Tape and reel
STPS2150A	2150	SMA	0.068 g	5000	Ammopack
STPS2150	STPS2150	DO-15	0.4 g	2000	Tape and reel

Revision history

Table 8. Document revision history

Date	Revision	Changes
Jul-2003	3A	Last update.
Aug-2004	4	SMA package dimensions update. Reference A1 max. changed from 2.70mm (0.106) to 2.03mm (0.080).
31-May-2006	5	Reformatted to current standard. Added ECOPACK statement. Updated SMA footprint in Figure 15. Changed nF to pF in Figure 10.
18-Sep-2008	6	Reformatted to current standard. Added SMAflat package. Removed $I_{F(RMS)}$ from Table 2.
04-Jul-2018	7	Removed SMAFlat package information. Updated Table 1 and Figure 3 .
25-Sep-2019	8	Added Section 2.2 SMA Flat Notch package information .

IMPORTANT NOTICE – PLEASE READ CAREFULLY

STMicroelectronics NV and its subsidiaries (“ST”) reserve the right to make changes, corrections, enhancements, modifications, and improvements to ST products and/or to this document at any time without notice. Purchasers should obtain the latest relevant information on ST products before placing orders. ST products are sold pursuant to ST’s terms and conditions of sale in place at the time of order acknowledgement.

Purchasers are solely responsible for the choice, selection, and use of ST products and ST assumes no liability for application assistance or the design of Purchasers’ products.

No license, express or implied, to any intellectual property right is granted by ST herein.

Resale of ST products with provisions different from the information set forth herein shall void any warranty granted by ST for such product.

ST and the ST logo are trademarks of ST. For additional information about ST trademarks, please refer to www.st.com/trademarks. All other product or service names are the property of their respective owners.

Information in this document supersedes and replaces information previously supplied in any prior versions of this document.

© 2019 STMicroelectronics – All rights reserved