

Uninorm

Control panel mounting enclosure



NGS 9411

Order no.: 17941101

* = Available on request.

Characteristics

Colour of enclosure group

Black

Protection class

IP 40

Enclosure Material

Modified PPE+PS (SE1 GFN1); for details see Technical Information

Scope of delivery

Enclosure, standard front frame, rear lid, screws

NGS 9806-GR: Enclosure, standard front frame, 2 clamps

Note

NGS-9806-GR design with stepped rear panel.

Dimensions

Dimensions

96 x 48 x 119 mm

Product drawing

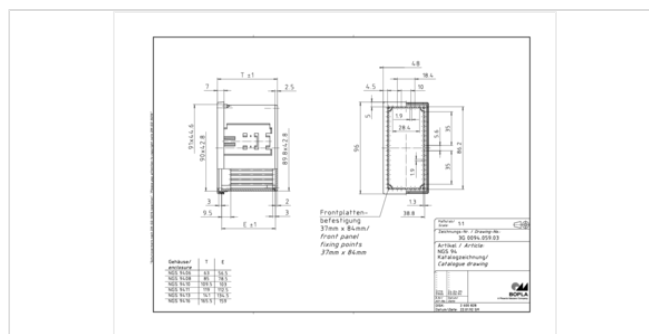

Technical documentation / Downloads

Technical drawings

3D product data in STEP format: 17941101 NGS-9411.stp (1.2 MB)

Drawing for mechanical processing: 17941101 NGS-9411-G.dxf (724.8 KB)

Milling contours are shown here as a DXF file. (Sub D, USB, HDMI, cable glands, ...)

Product drawing in PDF format: 17941101 NGS-9411.pdf (44.2 KB)

Product drawing in DXF format: 17941101 NGS-9411.dxf (456.4 KB)

17.10.2022

Product information

uninorm en.pdf (866.8 KB)

Important!

To compensate for pressure when temperatures change and cause moisture in the enclosure, we recommend that you use a pressure compensation element.

» [Additional information](#)

Matching accessories



Front lid with continuous membrane keypad, snaps firmly on

37994500 NGS 94 F For NGS 94..



Front frame with screw covers, snaps firmly on

37994600 NGS 94 SA For NGS 94..



Crystal-clear hood, snap-on, polycarbonate

37994700* NGS 94 AH For NGS 94..



Clear hood cover, flexible, up to IP 65 possible

37009400 NGS 94 GHN For NGS 94..



Spring clamp for fixing enclosure

37005000 NGS-NF



Screw clamp for screw-fitting enclosure

37003000 NGS-NK



Connecting piece for insertion of standard retaining clasps acc. to DIN 43835

37004000 NGS-ZE



Standard retaining clasp in accordance with DIN 43835 form B (only for use with NGS-ZE)

37001000 NGS-NH



Front panel seal (non-definable protection class)

37094010 NGS 94 DI For NGS 94..

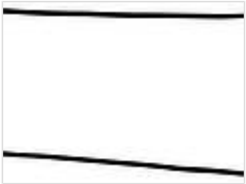

External control panel seal (non-definable protection class)

37094000 NGS 94 DA For NGS 94..



Front panels, 1,5 mm, natural-coloured anodised aluminium

37000300 NGS 94 FAE For NGS 94..



Plastic front panel, red translucent, 3 mm

37000800 NGS 94 FKT For NGS 94..