

TINA-Y-RS

~14° spot beam. Assembly with holder, installation tape and pins.

SPECIFICATION:

Dimensions	Ø 16.1 mm
Height	10 mm
Fastening	tape, pin
ROHS compliant	yes ⓘ



MATERIALS:

Component	Type	Material	Colour	Finish	Length
TINA-Y-RS	Single lens	PMMA	clear	gloss	14.7
TINA-Y-HLD	Holder	PC	black	gloss	16.1
TINA-Y-TAPE	Tape	Acrylic foam			

ORDERING INFORMATION:

Component	Qty in box	MOQ	MPQ	Box weight (kg)
CA18102_TINA-Y-RS » Box size: 476 x 273 x 197 mm	3900	300	300	5.6

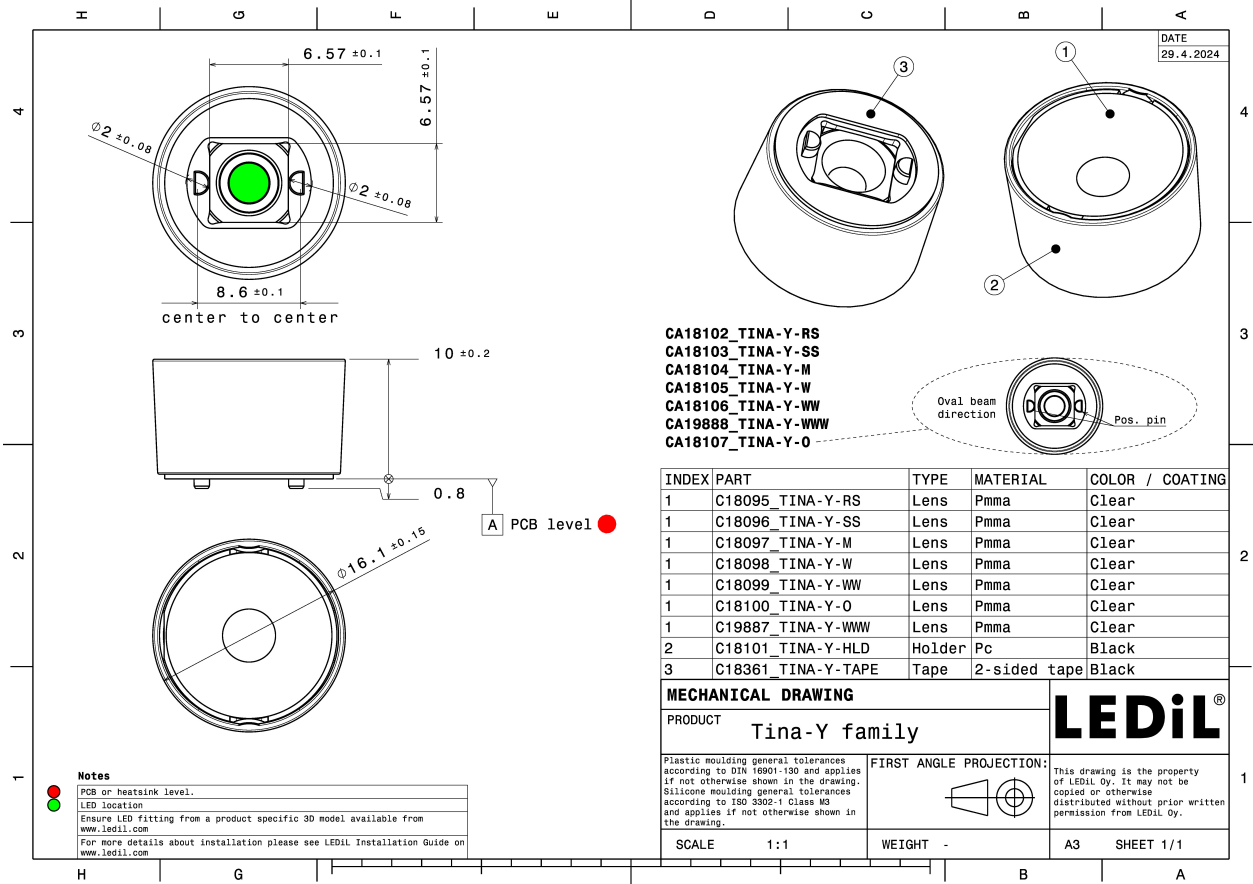

See also our general installation guide: www.ledil.com/installation_guide

OPTICAL RESULTS (MEASURED):



LED XP-G3
FWHM / FWTM 18.0° / 35.0°
Efficiency 81 %
Peak intensity 5.9 cd/lm
LEDs/each optic 1
Light colour/type White
Required components:

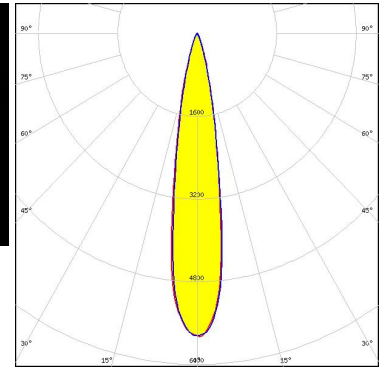

Light distribution files



LED XP-G4
FWHM / FWTM 17.0° / 31.0°
Efficiency 87 %
Peak intensity 7.7 cd/lm
LEDs/each optic 1
Light colour/type White
Required components:

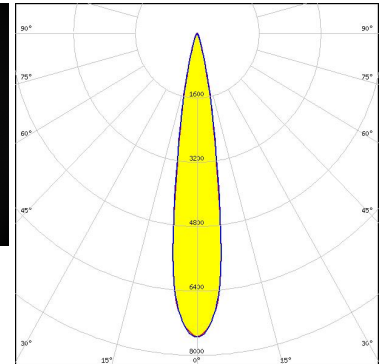

Light distribution files



LED NVSW719AC
FWHM / FWTM 16.0° / 29.0°
Efficiency 88 %
Peak intensity 8.8 cd/lm
LEDs/each optic 1
Light colour/type White
Required components:

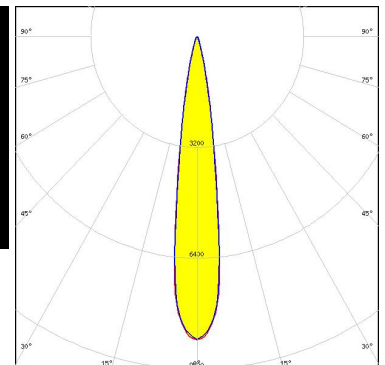

Light distribution files

OPTICAL RESULTS (MEASURED):

OSRAM
Opto Semiconductors

LED OSCONIQ C 3030
FWHM / FWTM 15.0° / 35.0°
Efficiency 83 %
Peak intensity 6.9 cd/lm
LEDs/each optic 1
Light colour/type White
Required components:

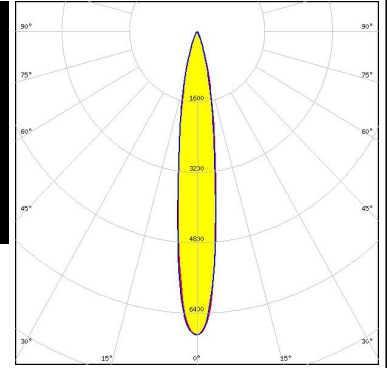

Light distribution files

OPTICAL RESULTS (SIMULATED):



LED J Series 3030C
FWHM / FWTM 15.0° / 32.0°
Efficiency 87 %
Peak intensity 8.3 cd/lm
LEDs/each optic 1
Light colour/type White
Required components:

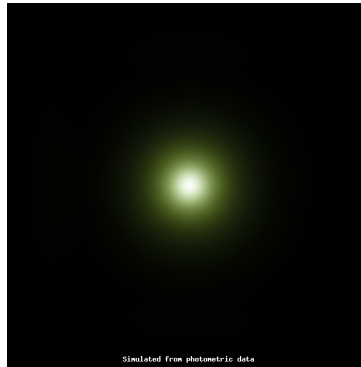

Light distribution files



LED XD16 Premium
FWHM / FWTM 12.0° / 24.0°
Efficiency 86 %
Peak intensity 13.4 cd/lm
LEDs/each optic 1
Light colour/type White
Required components:

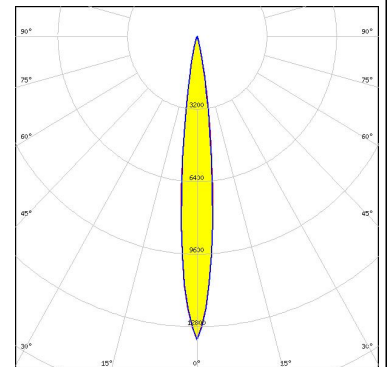

Light distribution files



LED XE-G
FWHM / FWTM 14.0° / 26.0°
Efficiency 87 %
Peak intensity 10.3 cd/lm
LEDs/each optic 1
Light colour/type White
Required components:

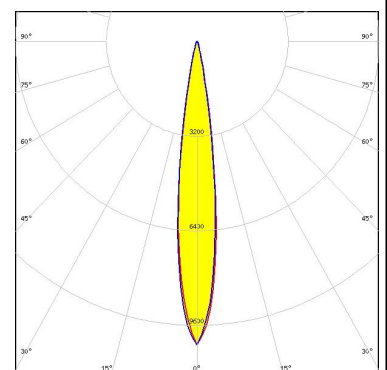

Light distribution files

OPTICAL RESULTS (SIMULATED):



LED XHP35.2 HD
 FWHM / FWTM 30.0° / 52.0°
 Efficiency 76 %
 Peak intensity 2.5 cd/lm
 LEDs/each optic 1
 Light colour/type White
 Required components:

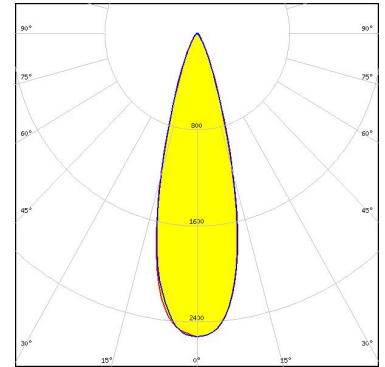

LED XHP35.2 HI
 FWHM / FWTM 22.0° / 44.0°
 Efficiency 84 %
 Peak intensity 3.9 cd/lm
 LEDs/each optic 1
 Light colour/type White
 Required components:

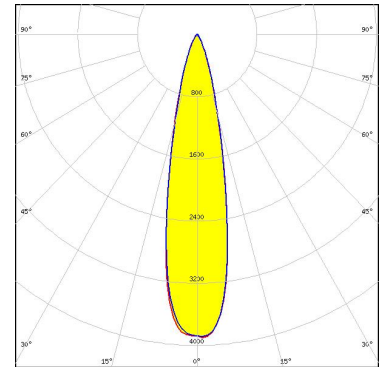

Light distribution files



LED XHP50.3 HI
 FWHM / FWTM 24.0° / 48.0°
 Efficiency 82 %
 Peak intensity 3.4 cd/lm
 LEDs/each optic 1
 Light colour/type White
 Required components:

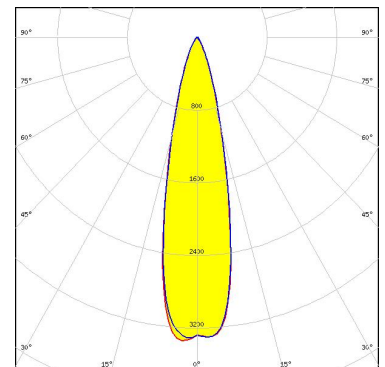

Light distribution files

OPTICAL RESULTS (SIMULATED):



LED XM-L RGBW (XMLDCL HD)
 FWHM / FWTM 30.0° / 49.0°
 Efficiency 85 %
 Peak intensity 2.8 cd/lm
 LEDs/each optic 1
 Light colour/type RGBW
 Required components:

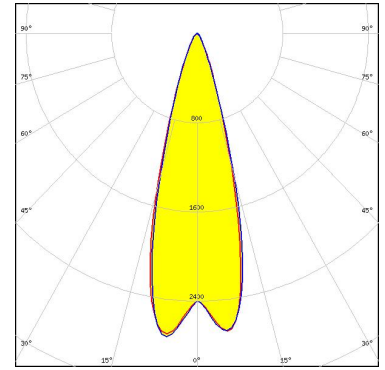

Light distribution files



LED XM-L RGBW (XMLDCL HI)
 FWHM / FWTM 20.0° / 37.0°
 Efficiency 85 %
 Peak intensity 5.3 cd/lm
 LEDs/each optic 1
 Light colour/type RGBW
 Required components:

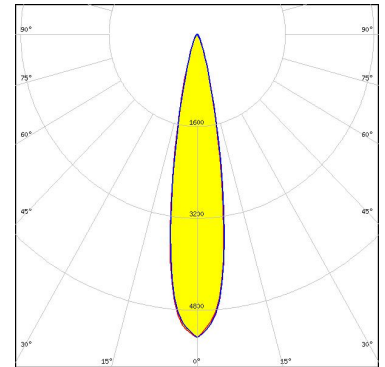

Light distribution files



LED XM-L3
 FWHM / FWTM 21.0° / 40.0°
 Efficiency 81 %
 Peak intensity 4.3 cd/lm
 LEDs/each optic 1
 Light colour/type White
 Required components:

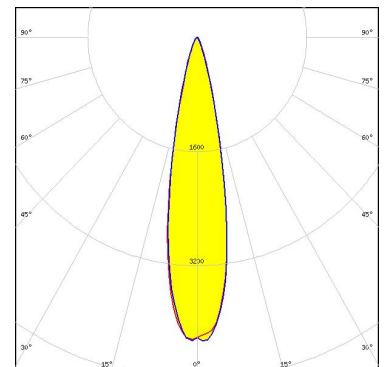

Light distribution files

OPTICAL RESULTS (SIMULATED):



LED XP-E2
 FWHM / FWTM 11.0° / 22.0°
 Efficiency 88 %
 Peak intensity 16 cd/lm
 LEDs/each optic 1
 Light colour/type White
 Required components:

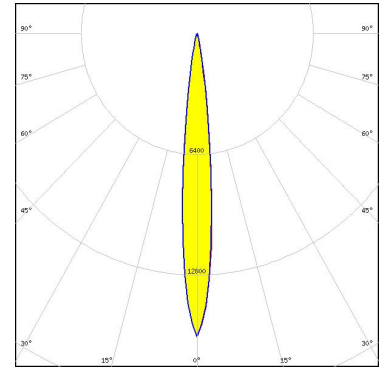

Light distribution files



LED XP-G2
 FWHM / FWTM 15.0° / 28.0°
 Efficiency 88 %
 Peak intensity 9.6 cd/lm
 LEDs/each optic 1
 Light colour/type White
 Required components:

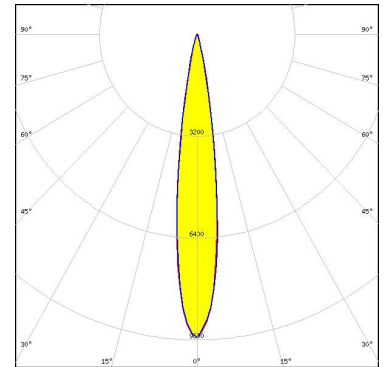

Light distribution files



LED XP-G4 HI
 FWHM / FWTM 12.0° / 24.0°
 Efficiency 86 %
 Peak intensity 12.9 cd/lm
 LEDs/each optic 1
 Light colour/type White
 Required components:

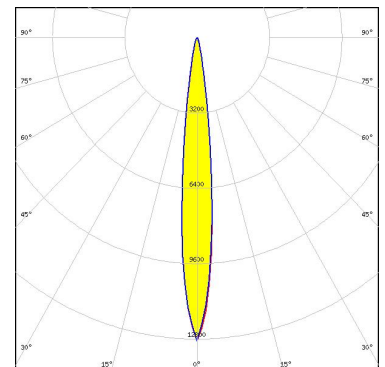

OPTICAL RESULTS (SIMULATED):



LED XP-P
 FWHM / FWTM 10.0° / 20.0°
 Efficiency 89 %
 Peak intensity 20.4 cd/m
 LEDs/each optic 1
 Light colour/type White
 Required components:

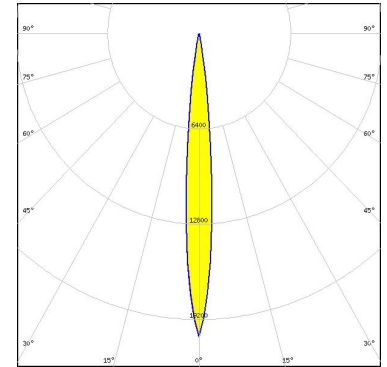

Light distribution files



LED XQ-E HD
 FWHM / FWTM 12.0° / 22.0°
 Efficiency 87 %
 Peak intensity 14.8 cd/m
 LEDs/each optic 1
 Light colour/type White
 Required components:

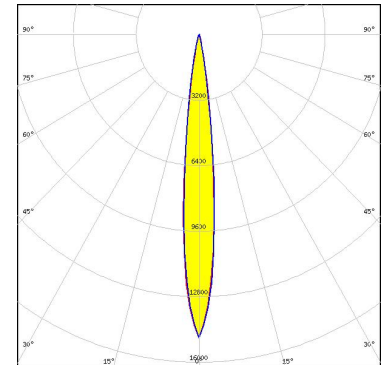

Light distribution files



LED XQ-E HI
 FWHM / FWTM 8.0° / 18.0°
 Efficiency 87 %
 Peak intensity 25.6 cd/m
 LEDs/each optic 1
 Light colour/type White
 Required components:

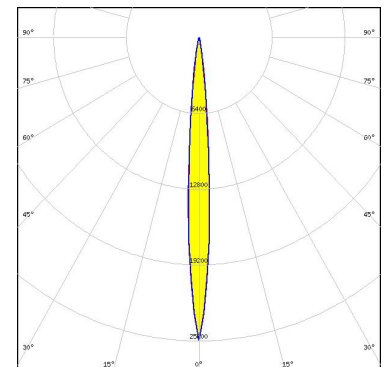

Light distribution files

OPTICAL RESULTS (SIMULATED):



LED LUXEON 5050 Round LES
FWHM / FWTM 28.0° / 56.0°
Efficiency 81 %
Peak intensity 2.5 cd/lm
LEDs/each optic 1
Light colour/type White
Required components:

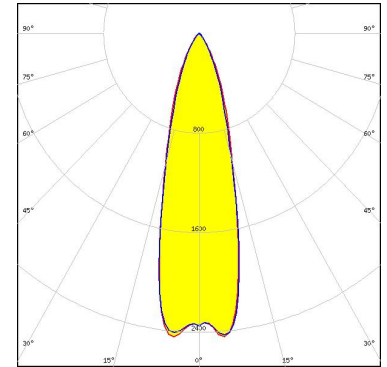

Light distribution files



LED LUXEON 5050 Square LES
FWHM / FWTM 26.0° / 56.0°
Efficiency 80 %
Peak intensity 2.5 cd/lm
LEDs/each optic 1
Light colour/type White
Required components:

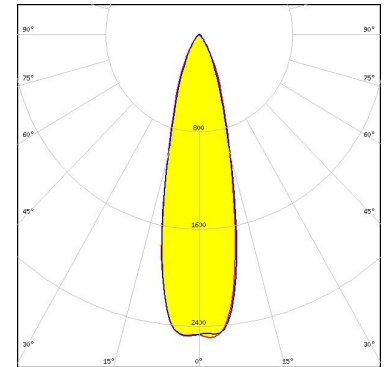

Light distribution files



LED LUXEON C
FWHM / FWTM 12.0° / 24.0°
Efficiency 79 %
Peak intensity 12.3 cd/lm
LEDs/each optic 1
Light colour/type White
Required components:

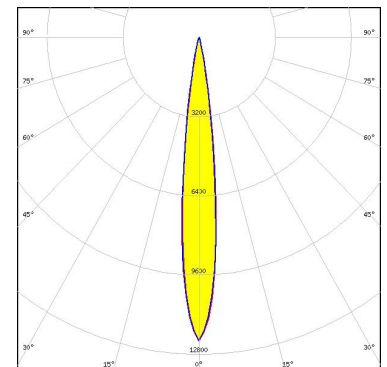

Light distribution files

OPTICAL RESULTS (SIMULATED):



LED LUXEON CZ
 FWHM / FWTM 10.0° / 19.0°
 Efficiency 88 %
 Peak intensity 21.4 cd/lm
 LEDs/each optic 1
 Light colour/type Red
 Required components:

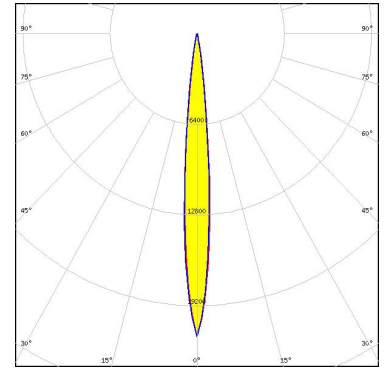

Light distribution files



LED LUXEON CZ
 FWHM / FWTM 8.0° / 18.0°
 Efficiency 88 %
 Peak intensity 25.5 cd/lm
 LEDs/each optic 1
 Light colour/type White
 Required components:

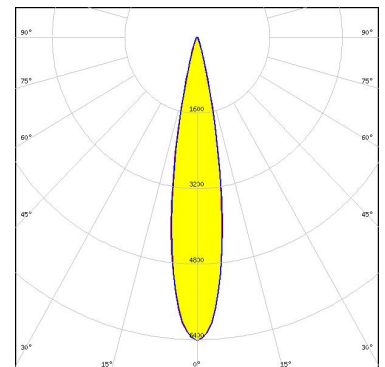

Light distribution files



LED LUXEON HL2X
 FWHM / FWTM 20.0° / 32.0°
 Efficiency 87 %
 Peak intensity 6.4 cd/lm
 LEDs/each optic 1
 Light colour/type White
 Required components:

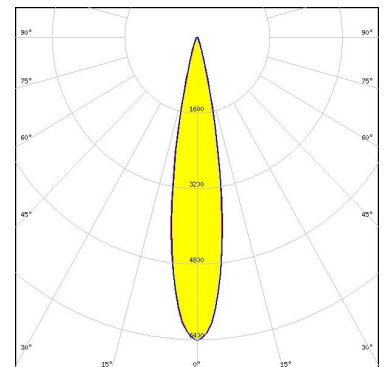

Light distribution files

OPTICAL RESULTS (SIMULATED):

LUMILEDS

LED	LUXEON HL2X
FWHM / FWTM	14.0° / 32.0°
Efficiency	83 %
Peak intensity	8.4 cd/lm
LEDs/each optic	1
Light colour/type	White
Required components:	

LUMILEDS

LED	LUXEON Rubix
FWHM / FWTM	8.0° / 18.0°
Efficiency	89 %
Peak intensity	24.7 cd/lm
LEDs/each optic	1
Light colour/type	White
Required components:	

LUMILEDS

LED	LUXEON Rubix
FWHM / FWTM	8.0° / 18.0°
Efficiency	89 %
Peak intensity	26.1 cd/lm
LEDs/each optic	1
Light colour/type	Blue
Required components:	

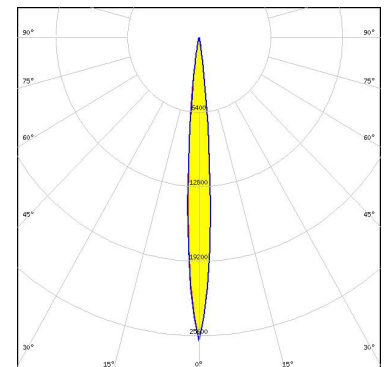

Light distribution files

OPTICAL RESULTS (SIMULATED):



LED LUXEON Z ES
FWHM / FWTM 12.0° / 24.0°
Efficiency 87 %
Peak intensity 13.1 cd/lm
LEDs/each optic 1
Light colour/type White
Required components:

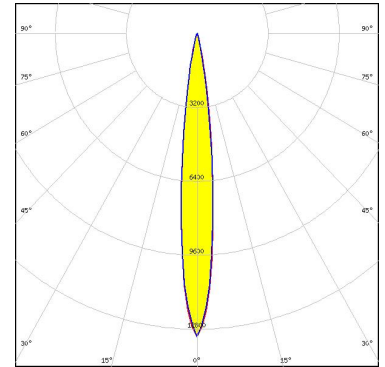

Light distribution files



LED SFT-12R-WES
FWHM / FWTM 8.0° / 18.0°
Efficiency 89 %
Peak intensity 27 cd/lm
LEDs/each optic 1
Light colour/type White
Required components:



LED SST-20
FWHM / FWTM 12.0° / 26.0°
Efficiency 86 %
Peak intensity 11.8 cd/lm
LEDs/each optic 1
Light colour/type White
Required components:

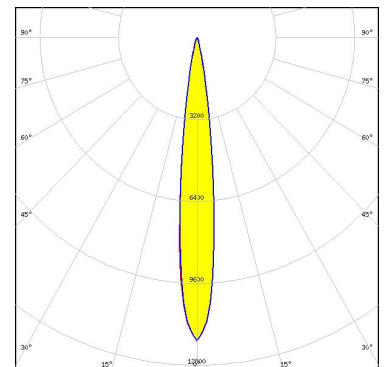

OPTICAL RESULTS (SIMULATED):

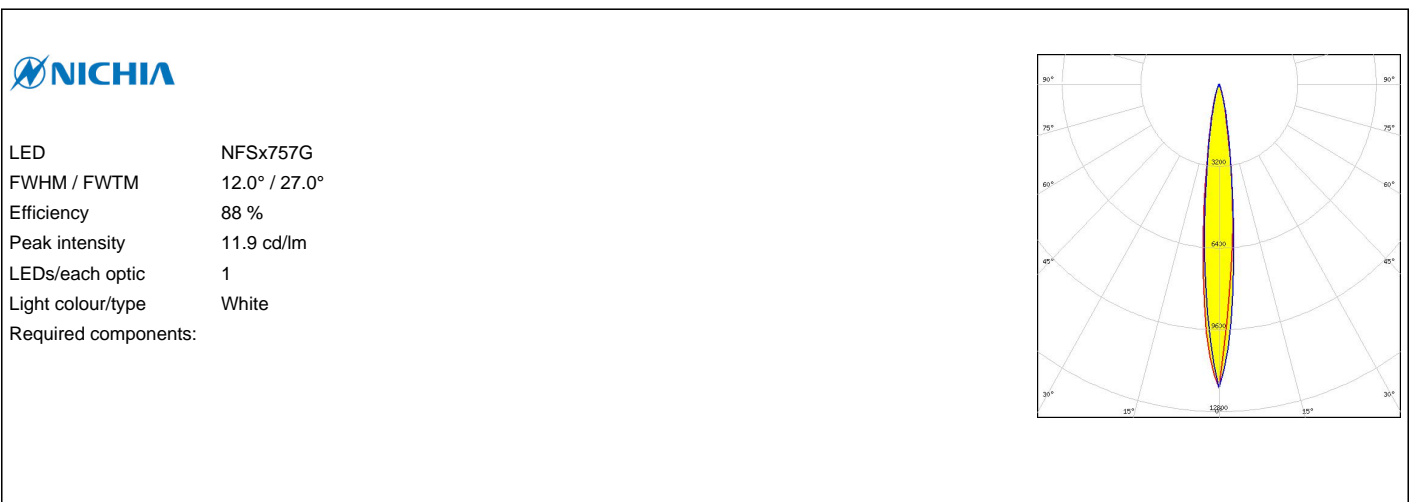
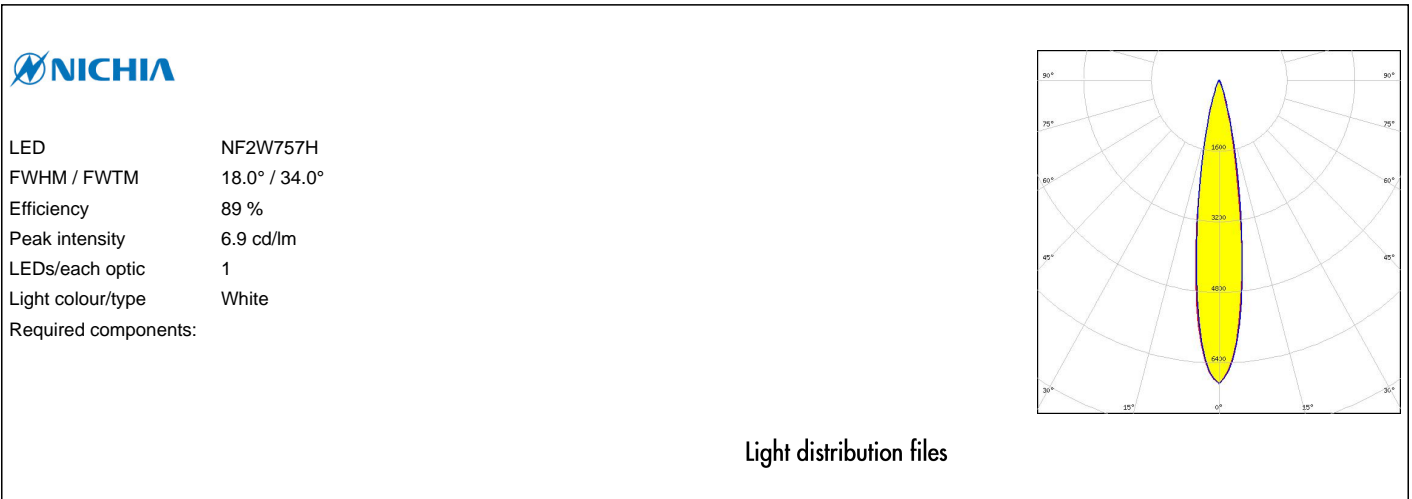

OPTICAL RESULTS (SIMULATED):

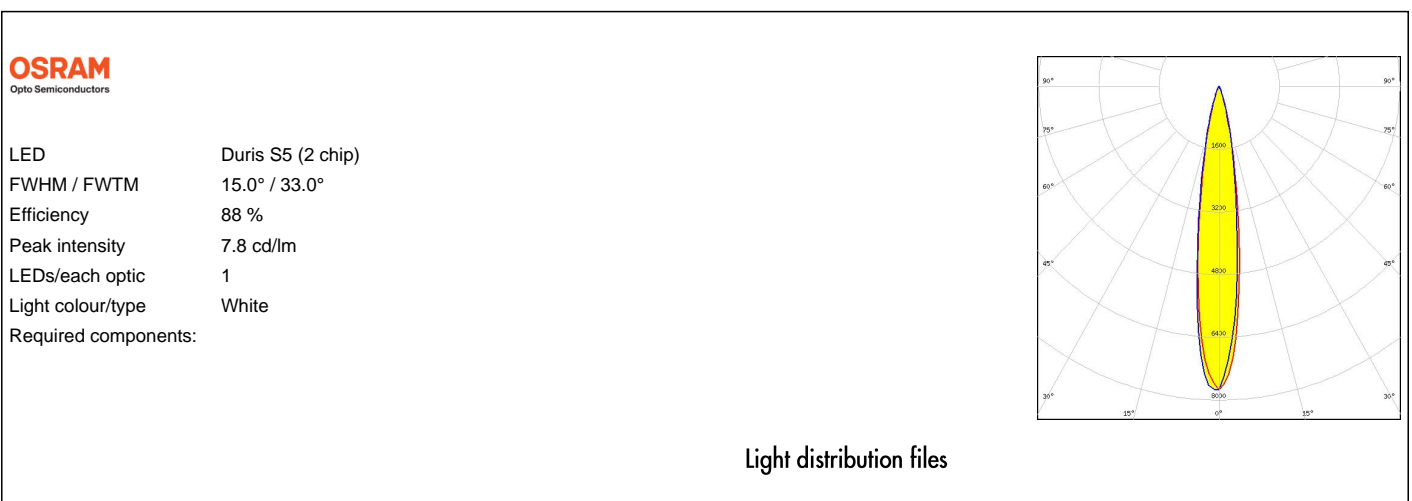
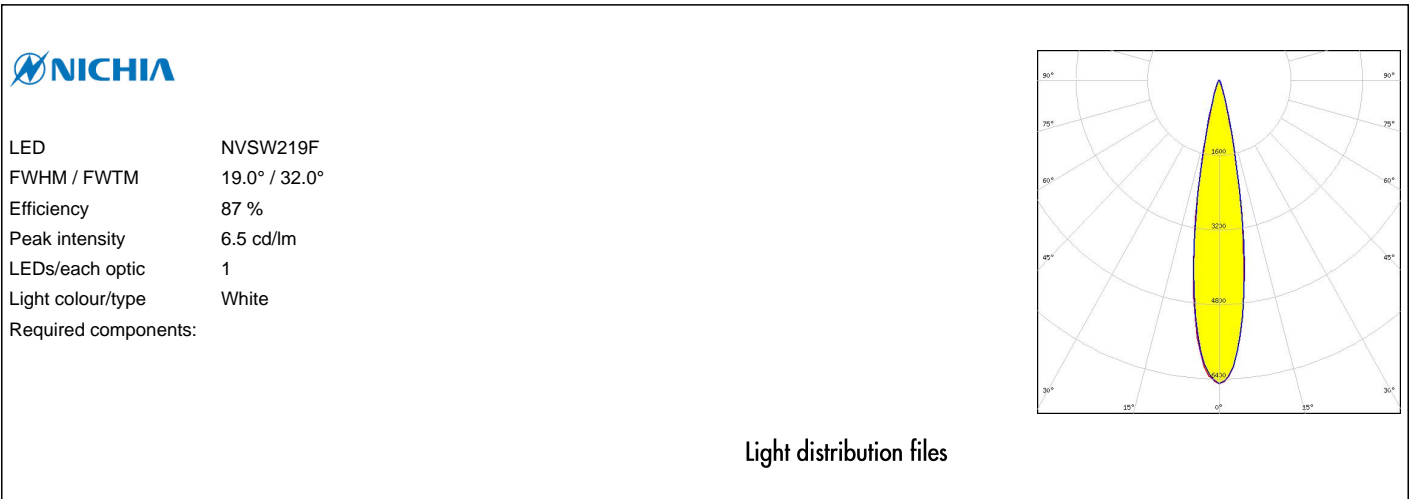

OPTICAL RESULTS (SIMULATED):

OSRAM
Opto Semiconductors

LED OSLON Pure 1414
 FWHM / FWTM 10.0° / 18.0°
 Efficiency 89 %
 Peak intensity 22.6 cd/lm
 LEDs/each optic 1
 Light colour/type White
 Required components:

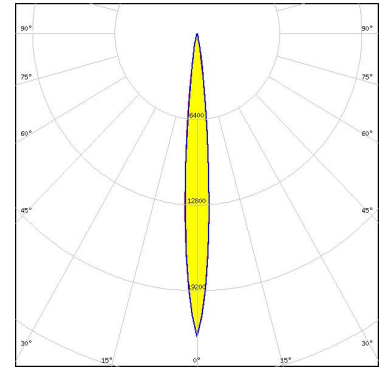

OSRAM
Opto Semiconductors

LED OSLON Square CSSRM2/CSSRM3
 FWHM / FWTM 12.0° / 23.0°
 Efficiency 87 %
 Peak intensity 15.3 cd/lm
 LEDs/each optic 1
 Light colour/type Far Red
 Required components:

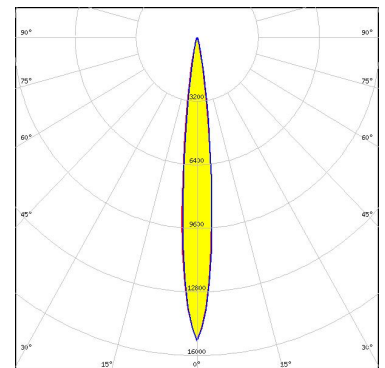

Light distribution files

OSRAM
Opto Semiconductors

LED OSLON Square CSSRM2/CSSRM3
 FWHM / FWTM 15.0° / 27.0°
 Efficiency 88 %
 Peak intensity 10 cd/lm
 LEDs/each optic 1
 Light colour/type White
 Required components:

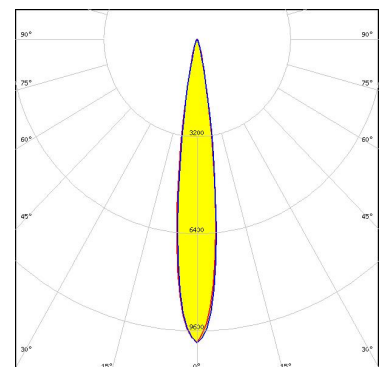

Light distribution files

OPTICAL RESULTS (SIMULATED):

OSRAM
Opto Semiconductors

LED OSLOM Square CSSRM2/CSSRM3
 FWHM / FWTM 17.0° / 30.0°
 Efficiency 87 %
 Peak intensity 7.8 cd/lm
 LEDs/each optic 1
 Light colour/type White
 Required components:

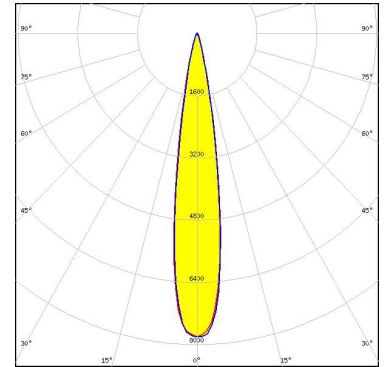

OSRAM
Opto Semiconductors

LED OSLOM SSL 150
 FWHM / FWTM 11.0° / 22.0°
 Efficiency 88 %
 Peak intensity 17.2 cd/lm
 LEDs/each optic 1
 Light colour/type White
 Required components:

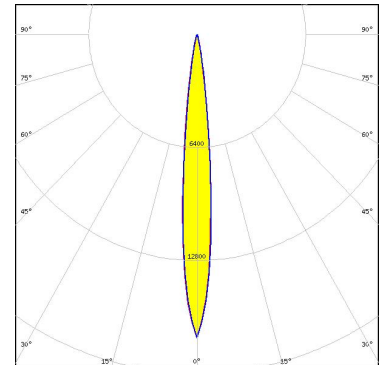

Light distribution files

OSRAM
Opto Semiconductors

LED SFH 4715AS
 FWHM / FWTM 16.0° / 30.0°
 Efficiency 86 %
 Peak intensity 8.5 cd/lm
 LEDs/each optic 1
 Light colour/type IR
 Required components:

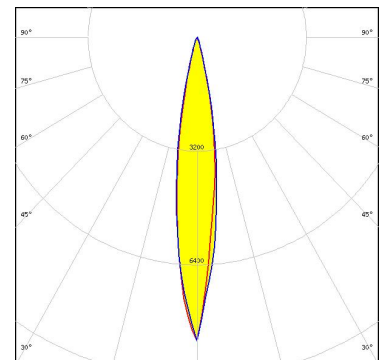
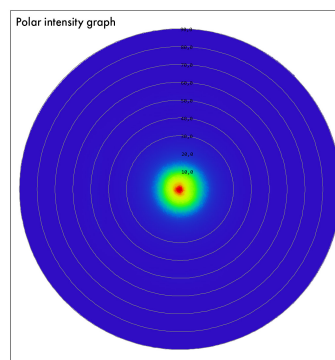

Light distribution files

OPTICAL RESULTS (SIMULATED):

OSRAM
Opto Semiconductors

LED SFH 4716S
FWHM / FWTM 11.0° / 22.0°
Efficiency 86 %
LEDs/each optic 1
Light colour/type IR
Required components:

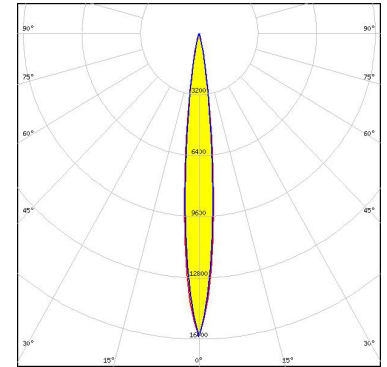
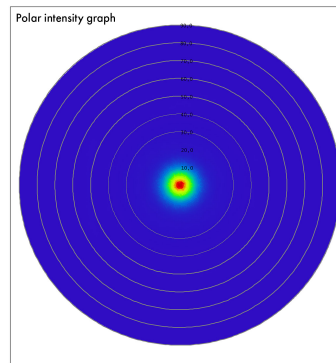

Light distribution files

OSRAM
Opto Semiconductors

LED SFH 4725AS
FWHM / FWTM 18.0° / 32.0°
Efficiency 87 %
LEDs/each optic 1
Light colour/type IR
Required components:

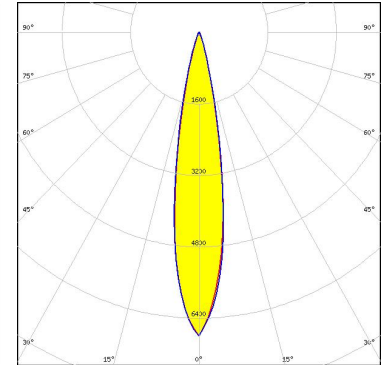
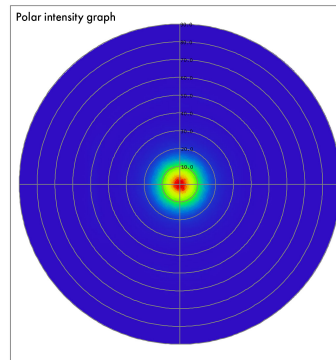

Light distribution files

OSRAM
Opto Semiconductors

LED SFH 4725S
FWHM / FWTM 13.0° / 28.0°
Efficiency 87 %
LEDs/each optic 1
Light colour/type IR
Required components:

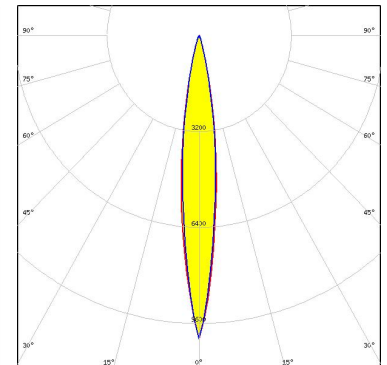
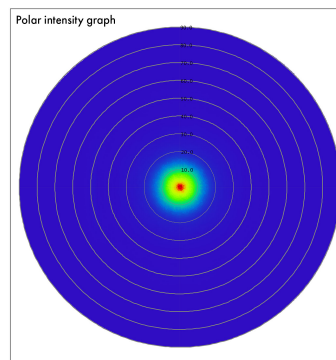

Light distribution files

OPTICAL RESULTS (SIMULATED):

SAMSUNG

LED LH351B
FWHM / FWTM 20.0° / 34.0°
Efficiency 86 %
Peak intensity 6.2 cd/lm
LEDs/each optic 1
Light colour/type White
Required components:

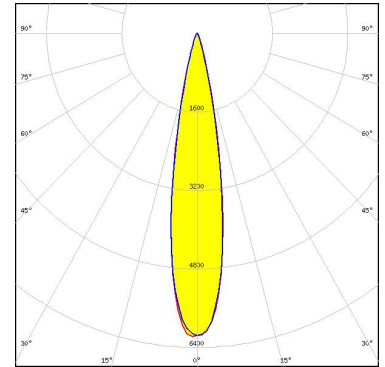

Light distribution files

STANLEY

LED MGN1108MS
FWHM / FWTM 12.0° / 20.0°
Efficiency 88 %
LEDs/each optic 1
Light colour/type IR
Required components:

STANLEY

LED MJN1108MS
FWHM / FWTM 12.0° / 20.0°
Efficiency 89 %
LEDs/each optic 1
Light colour/type IR
Required components:

GENERAL INFORMATION:

NOTE: The typical beam angle will be changed by different color, chip size and chip position tolerance. The typical total beam angle is the full angle measured where the luminous intensity is half of the peak value.

MATERIALS:

As part of our continuous research and improvement processes, and to ensure the best possible quality and availability of our products, LEDiL reserves the right to change material grades without notice.

PRODUCT DATA USER AGREEMENT AND DISCLAIMER:

The measured data in the provided downloadable LEDiL Product Datasheets and Mechanical 2D-Drawings is rounded and provided as reference for planning. LEDiL Oy's optical specifications have been verified by conducting performance testing of the products in accordance with the company's quality system. The reported data are averaged results of multiple measurements with typical variation. LEDiL Oy reserves the right to without prior notification make changes and improvements to its products.

LEDiL Oy assumes neither warranty, nor guarantee nor any other liability of any kind for the contents and correctness of the provided data. The provided data has been generated with highest diligence but the provided data may in reality not represent the complete possible variation range of all intrinsic parameters. Therefore, in certain cases a deviation from the provided data could occur.

LEDiL Oy reserves the right to undertake technical changes of its products without further notification which could lead to changes in the provided data. LEDiL Oy assumes no liability of any kind for the possible deviation from any provided data or any other damage resulting from the usage of the provided data.

The user agrees to this disclaimer and user agreement with the download or usage of the provided files.

LEDiL Oy

Joensuunkatu 13
FI-24240 SALO
Finland

LEDiL Inc.

228 West Page Street
Suite D
Sycamore IL 60178
USA

Ledil Optics Technology (Shenzhen) Co., Ltd.

405 , Block B
Casic Motor Building
Shenzhen 518057
P.R.CHINA

Local sales and technical support

[www.ledil.com/
where_to_buy](http://www.ledil.com/where_to_buy)

Shipping locations

Poznan, Poland
Hong Kong, China

Distribution Partners

[www.ledil.com/
where_to_buy](http://www.ledil.com/where_to_buy)