

ONE SIDE NO FEEDBACK

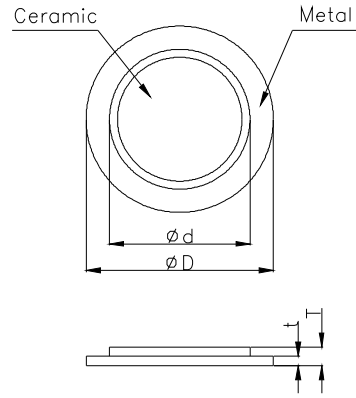

MODEL NO.	RESONANT FREQUENCY	RESONANT IMPEDANCE max.	CAPACITY $\pm 30\%$ pF	DIMENSIONS				PLATE MATERIAL
	KHz	Ω		D mm	d mm	T mm	t mm	
MZ-41070T00	0.7	1000	70000	41.0	25.0	0.23	0.10	Nickel-Alloy