

FEATURES

- Low Forward Voltage Drop
- Guard Ring Construction for Transient Protection
- High Conductance
- Also Available in Lead Free Version

SOD-123 Plastic-Encapsulate Diodes

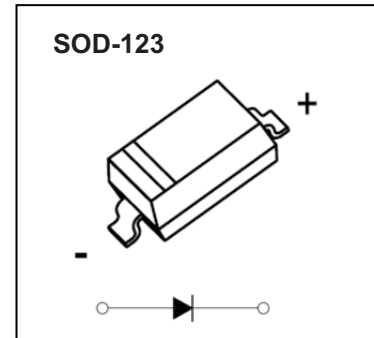

MARKING:SF



Maximum Ratings @Ta=25°C

Parameter	Symbo	Value	Unit
Peak repetitive peak reverse voltage	V_{RRM}	40	V
Working peak reverse voltage	V_{RWM}		
DC blocking voltage	V_R		
RMS reverse voltage reverse voltage (DC)	$V_{R(RMS)}$	28	V
Average rectified output current	I_o	0.5	A
Non-repetitive Peak Forward Surge Current @t=8.3ms	I_{FSM}	5.5	A
Power dissipation	P_D	500	mW
Thermal resistance junction to ambient	$R_{\theta JA}$	200	°C/W
Operating Junction Temperature Range	T_j	-40 ~ +125	°C
Storage Temperature Range	T_{STG}	-55 ~ +150	°C
Voltage rate of change	dv/dt	1000	V/μs

Electrical Characteristics @Ta=25°C

	Symbol	Test conditions	Min	Typ	Max	Unit
Reverse breakdown voltage	$V_{(BR)}$	$I_R=20\mu A$	40			V
Reverse current	I_R	$V_R=20V$			10	μA
		$V_R=40V$			20	
Forward voltage	V_F	$I_F=0.5A$			0.51	V
		$I_F=1.0A$			0.62	
Capacitance between terminals	C_T	$V_R=0, f=1MHz$			170	pF

Typical Characteristics

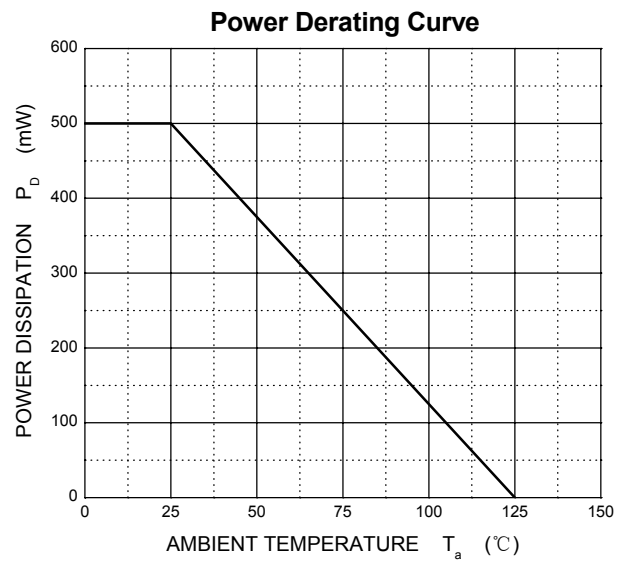
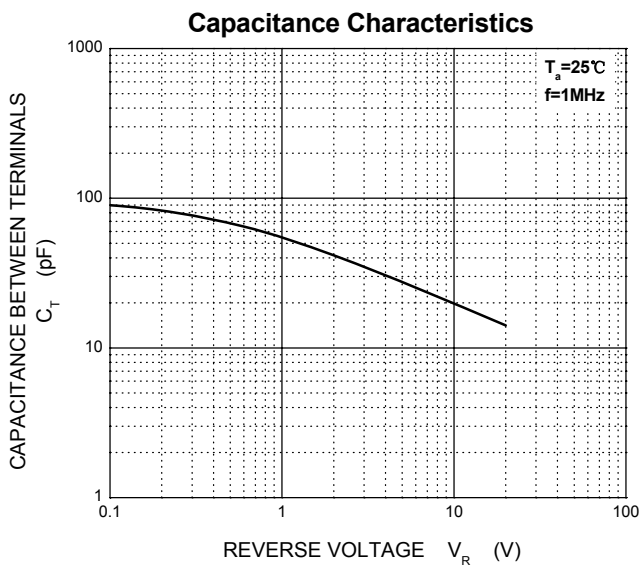
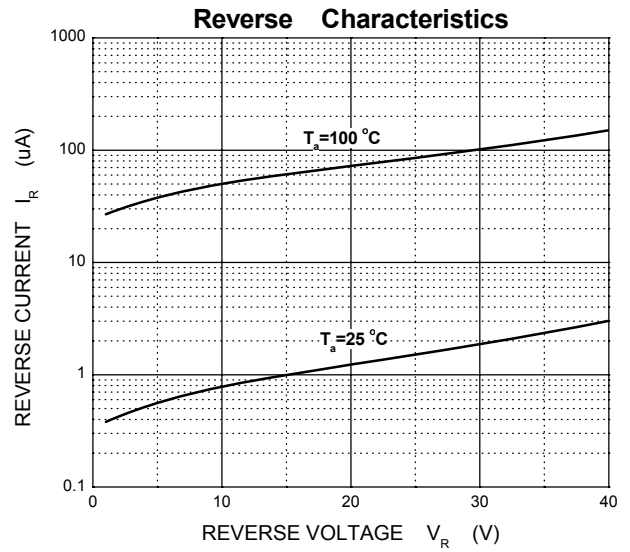
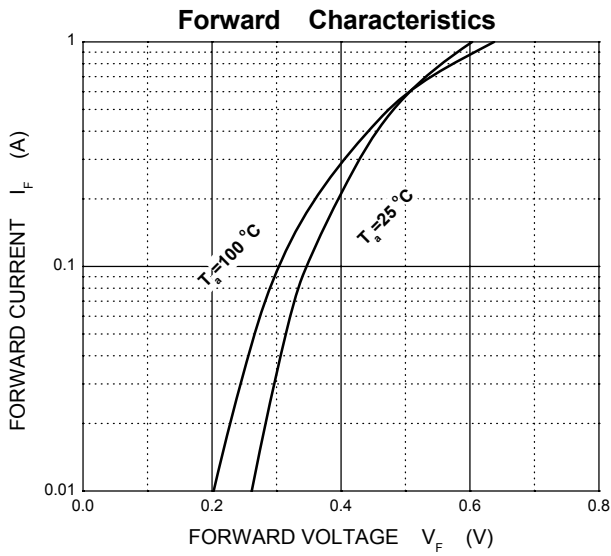

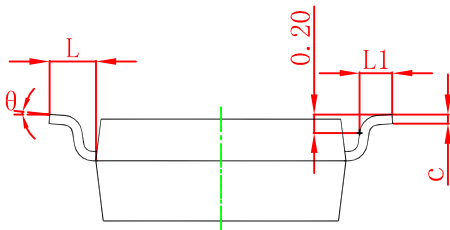
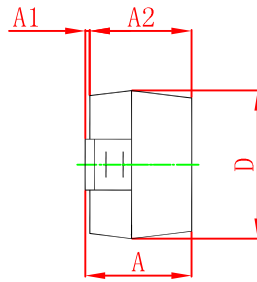
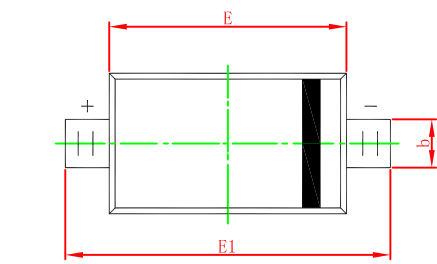
SOD-123 Package Outline Dimensions

Symbol	Dimensions In Millimeters		Dimensions In Inches	
	Min	Max	Min	Max
A	1.050	1.250	0.041	0.049
A1	0.000	0.100	0.000	0.004
A2	1.050	1.150	0.041	0.045
b	0.450	0.650	0.018	0.026
c	0.080	0.150	0.003	0.006
D	1.500	1.700	0.059	0.067
E	2.600	2.800	0.102	0.110
E1	3.550	3.850	0.140	0.152
L	0.500 REF		0.020 REF	
L1	0.250	0.450	0.010	0.018
θ	0°	8°	0°	8°

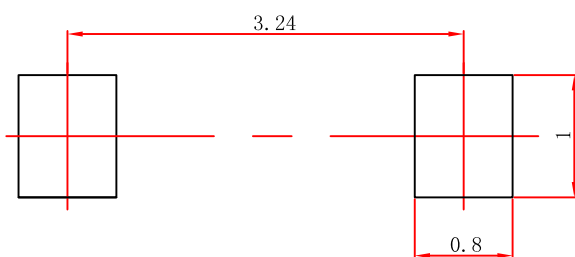
SOD-123 Suggested Pad Layout

Note:

1. Controlling dimension: in millimeters.
2. General tolerance: $\pm 0.05\text{mm}$.
3. The pad layout is for reference purposes only.