

DAISY-1X1-WW

~80° wide beam

SPECIFICATION:

Dimensions	40.0 x 40.0 mm
Height	20.4 mm
Fastening	clips
ROHS compliant	yes ⓘ

MATERIALS:

Component	Type	Material	Colour	Finish	Length
CA19071_DAISY-1X1-WW	Assembly				
C19062_DAISY-1X1-SHD-MET-MATT	Shade	PC	metal		20.0
C19061_DAISY-1X1-SHD-MET	Shade	PC	metal		20.0
C19060_DAISY-1X1-SHD-MATT	Shade	PC	black		20.0
C19059_DAISY-1X1-SHD-WHT	Shade	PC	white		20.0
C19058_DAISY-1X1-SHD	Shade	PC	black		20.0

ORDERING INFORMATION:

Quantities for one set:

Shade	1
Assembly	1

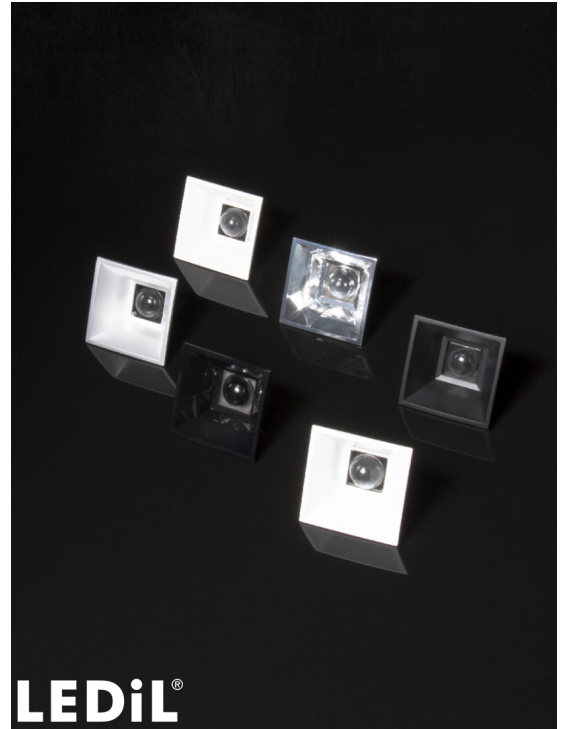

Component		Qty in box	MOQ	MPQ	Box weight (kg)
C19061_DAISY-1X1-SHD-MET » Box size: 400 x 400 x 275 mm	Shade	672	112	56	5.5
C19062_DAISY-1X1-SHD-MET-MATT » Box size: 400 x 400 x 275 mm	Shade	672	112	56	5.4
C19058_DAISY-1X1-SHD » Box size: 400 x 400 x 275 mm	Shade	672	112	56	5.5
C19059_DAISY-1X1-SHD-WHT » Box size: 400 x 400 x 275 mm	Shade	672	112	56	5.5
C19060_DAISY-1X1-SHD-MATT » Box size: 400 x 400 x 275 mm	Shade	672	112	56	5.4
CA19071_DAISY-1X1-WW » Box size: 400 x 300 x 300 mm	Assembly	2016	112	112	3.7

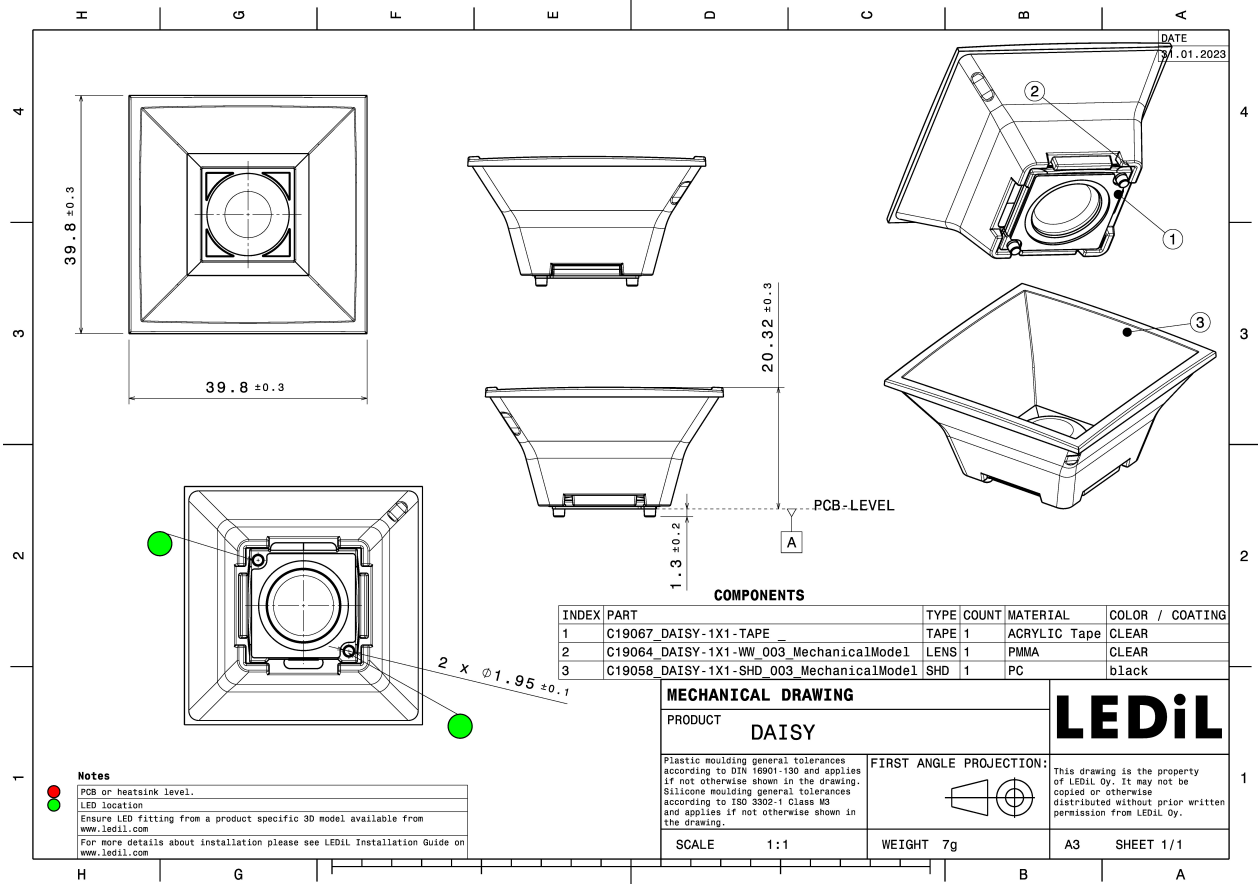

See also our general installation guide: www.ledil.com/installation_guide

OPTICAL RESULTS (MEASURED):

MST | *Your solutions*

LED RecLED 35x34mm 400lm 36V SELV DAISY-1X1 G1
FWHM / FWTM 80.0° / 89.0°
Efficiency 87 %
Peak intensity 0.6 cd/lm
LEDs/each optic 4
Light colour/type White
Required components:
C19058_DAISSY-1X1-SHD

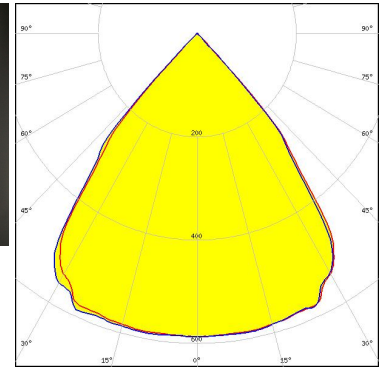
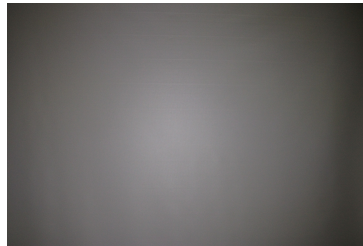

Light distribution files

MST | *Your solutions*

LED RecLED 35x34mm 400lm 36V SELV DAISY-1X1 G1
FWHM / FWTM 77.0° / 89.0°
Efficiency 95 %
Peak intensity 0.7 cd/lm
LEDs/each optic 4
Light colour/type White
Required components:
C19061_DAISSY-1X1-SHD-MET

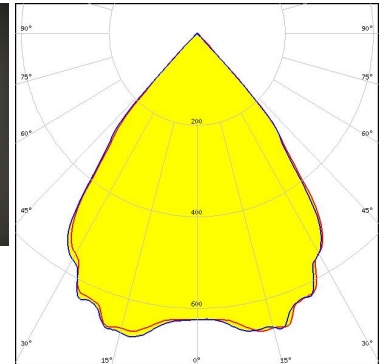
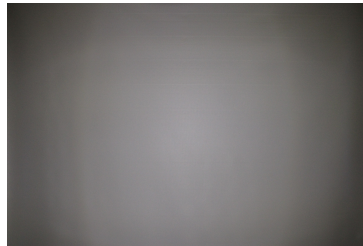

Light distribution files

MST | *Your solutions*

LED RecLED 35x34mm 400lm 36V SELV DAISY-1X1 G1
FWHM / FWTM 79.0° / 89.0°
Efficiency 86 %
Peak intensity 0.6 cd/lm
LEDs/each optic 4
Light colour/type White
Required components:
C19060_DAISSY-1X1-SHD-MATT

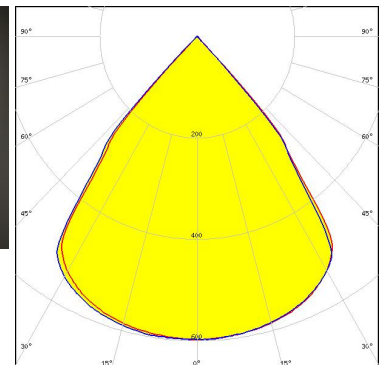
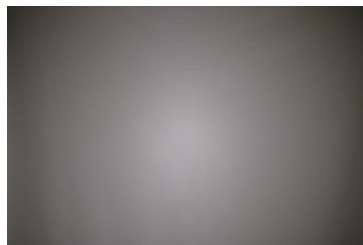

Light distribution files

OPTICAL RESULTS (MEASURED):

MST | *Your solutions*

LED RecLED 35x34mm 400lm 36V SELV DAISY-1X1 G1
FWHM / FWTM 77.0° / 89.0°
Efficiency 94 %
Peak intensity 0.7 cd/lm
LEDs/each optic 4
Light colour/type White
Required components:
C19062_DAISY-1X1-SHD-MET-MATT

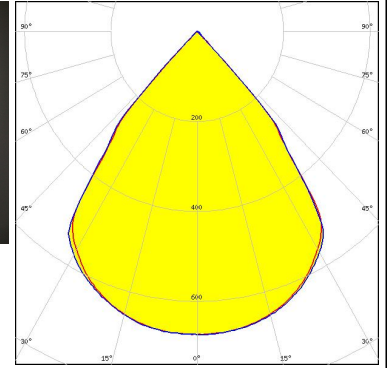
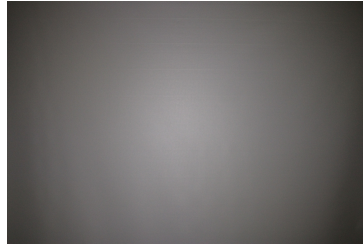

Light distribution files

OPTICAL RESULTS (SIMULATED):

SAMSUNG

LED LH502D
FWHM / FWTM 77.0° / 86.0°
Efficiency 89 %
Peak intensity 0.7 cd/lm
LEDs/each optic 1
Light colour/type White
Required components:
C19058_DAISY-1X1-SHD

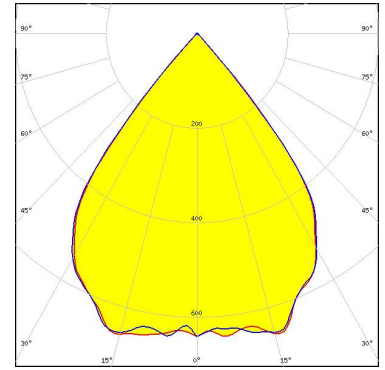

SAMSUNG

LED LM28xB Series
FWHM / FWTM 76.0° / 88.0°
Efficiency 89 %
Peak intensity 0.7 cd/lm
LEDs/each optic 4
Light colour/type White
Required components:
C19058_DAISY-1X1-SHD

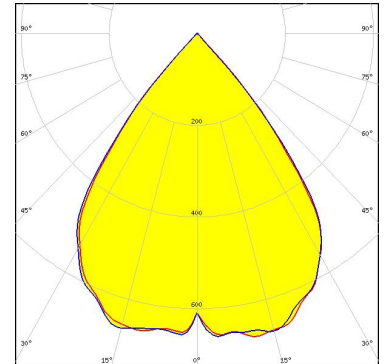

GENERAL INFORMATION:

NOTE: The typical beam angle will be changed by different color, chip size and chip position tolerance. The typical total beam angle is the full angle measured where the luminous intensity is half of the peak value.

MATERIALS:

As part of our continuous research and improvement processes, and to ensure the best possible quality and availability of our products, LEDiL reserves the right to change material grades without notice.

PRODUCT DATA USER AGREEMENT AND DISCLAIMER:

The measured data in the provided downloadable LEDiL Product Datasheets and Mechanical 2D-Drawings is rounded and provided as reference for planning. LEDiL Oy's optical specifications have been verified by conducting performance testing of the products in accordance with the company's quality system. The reported data are averaged results of multiple measurements with typical variation. LEDiL Oy reserves the right to without prior notification make changes and improvements to its products.

LEDiL Oy assumes neither warranty, nor guarantee nor any other liability of any kind for the contents and correctness of the provided data. The provided data has been generated with highest diligence but the provided data may in reality not represent the complete possible variation range of all intrinsic parameters. Therefore, in certain cases a deviation from the provided data could occur.

LEDiL Oy reserves the right to undertake technical changes of its products without further notification which could lead to changes in the provided data. LEDiL Oy assumes no liability of any kind for the possible deviation from any provided data or any other damage resulting from the usage of the provided data.

The user agrees to this disclaimer and user agreement with the download or usage of the provided files.

LEDiL Oy

Joensuunkatu 13
FI-24240 SALO
Finland

LEDiL Inc.

228 West Page Street
Suite D
Sycamore IL 60178
USA

Ledil Optics Technology (Shenzhen) Co., Ltd.

405 , Block B
Casic Motor Building
Shenzhen 518057
P.R.CHINA

Local sales and technical support

[www.ledil.com/
where_to_buy](http://www.ledil.com/where_to_buy)

Shipping locations

Poznan, Poland
Hong Kong, China

Distribution Partners

[www.ledil.com/
where_to_buy](http://www.ledil.com/where_to_buy)