

FPC/FFC Connector

XF3M/XF2M

XF3M

Rotary Backlock Connector (0.5-mm Pitch, 1.0-mm Pitch, Dual sided, Upper sided Contact)

Rotary Backlock Connectors Provide Improved Insertion of FPC/FFC Cables and helps Confirm Proper Connection with Sure Lock Feel.

- Models available with 0.5-mm or 1.0-mm pitch.
- Models available with dual-sided contacts or upper sided. (Models with upper sided come only with a 0.5-mm pitch.)
- Models available with gold or Tin-plated. (Tin-plated is available only with models with dual-sided contacts.)
- Models with 80 pins (multiple type) available with 0.5-mm pitch.
- Applicable FPC/FFC thickness of 0.3 mm.
- Halogen Free (*)

* OMRON uses the following standard to determine halogen-free construction: 900 ppm max. for Br, 900 ppm max. for Cl, and 1,500 ppm max. for Br+Cl.

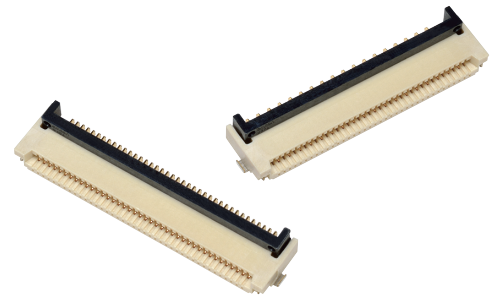

XF2M

Rotary Backlock Connector (0.5-mm Pitch, Dual sided Contact)

Rotary Backlock Connectors Provide High-reliability and Superior Work Efficiency.

- Dual-sided contact reduces the number of parts.
- Applicable FPC/FFC thickness of 0.3 mm (Gold-plated type).
- Halogen Free (*)

* OMRON uses the following standard to determine halogen-free construction: 900 ppm max. for Br, 900 ppm max. for Cl, and 1,500 ppm max. for Br+Cl.

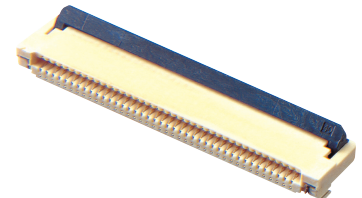

XF3M

For FPC/FFC

Rotary Backlock Connectors Provide Improved Insertion of FPC/FFC Cables and helps Confirm Proper Connection with Sure Lock Feel.

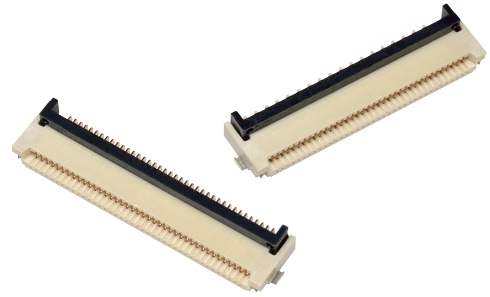

- Models available with 0.5-mm or 1.0-mm pitch.
- Models available with dual-sided contacts or upper sided.
(Models with upper sided come only with a 0.5-mm pitch.)
- Models available with gold or Tin-plated.
(Tin-plated is available only with models with dual-sided contacts.)
- Models with 80 pins (multiple type) available with 0.5-mm pitch.
- Applicable FPC/FFC thickness of 0.3 mm.
- Halogen Free (*)

* OMRON uses the following standard to determine halogen-free construction: 900 ppm max. for Br, 900 ppm max. for Cl, and 1,500 ppm max. for Br+Cl.

Models

Pitch	Contact type	Dual-sided contact		Upper sided	
		Contacts	Model	Contacts	Model
0.5 mm	Gold-plated (flash)		XF3M-□□15-1B□	Gold-plated (flash)	XF3M-□□25-1B
	Tin-plated		XF3M-□□15-1D		
1.0 mm	Gold-plated (flash)		XF3M(1)-□□15-1B		
	Tin-plated		XF3M(1)-□□15-1D		

Ratings and Specifications

Rated current	0.5 A AC/DC
Rated voltage	50 V AC/DC
Contact resistance	50 mΩ max. (at 20 mV DC max., 100 mA max.)
Insulation resistance	100 MΩ min. (at 250 V DC)
Dielectric strength	250 V AC for 1 min. (leakage current: 1 mA max.)
Insertion durability	Gold-plated: 20 times Tin-plated: 10 times
Ambient operating temperature	-30 to 85 °C (With no icing or condensation)

Materials and Finish

Item	Model	Dual-sided Contact Models		Upper sided Models
		Gold-plated	Tin-plated	Gold-plated
Housing		LCP resin (UL94 V-0)/natural		LCP resin (UL94 V-0)/gray
Slider		LCP resin (UL94 V-0)/black		
Contacts		Spring copper alloy/nickel substrate (1.5 μm)		
		Gold-plated contacts (flash)	Tin-plated contacts (1 μm)	Gold-plated contacts (flash)
Hold-down		Copper alloy/tin-plated (1 μm)		

XF3M 0.5-mm pitch model

Ordering Information

Dual-sided Contact Models - Gold-plated (flash)

Standard reel

Pins *1	Model	Pins *1	Model	Pins *1	Model	Pins *1	Model	Quantity per reel (unit) *2
4	XF3M-0415-1B	16	XF3M-1615-1B	29	XF3M-2915-1B	42	XF3M-4215-1B	4 to 60 pins: 1,500 80 pins: 1,000
5	XF3M-0515-1B	17	XF3M-1715-1B	30	XF3M-3015-1B	45	XF3M-4515-1B	
6	XF3M-0615-1B	18	XF3M-1815-1B	31	XF3M-3115-1B	50	XF3M-5015-1B	
7	XF3M-0715-1B	19	XF3M-1915-1B	32	XF3M-3215-1B	51	XF3M-5115-1B	
8	XF3M-0815-1B	20	XF3M-2015-1B	33	XF3M-3315-1B	53	XF3M-5315-1B	
9	XF3M-0915-1B	21	XF3M-2115-1B	34	XF3M-3415-1B	54	XF3M-5415-1B	
10	XF3M-1015-1B	22	XF3M-2215-1B	35	XF3M-3515-1B	55	XF3M-5515-1B	
11	XF3M-1115-1B	23	XF3M-2315-1B	36	XF3M-3615-1B	57	XF3M-5715-1B	
12	XF3M-1215-1B	24	XF3M-2415-1B	37	XF3M-3715-1B	60	XF3M-6015-1B	
13	XF3M-1315-1B	25	XF3M-2515-1B	38	XF3M-3815-1B	80	XF3M-8015-1BE	
14	XF3M-1415-1B	26	XF3M-2615-1B	40	XF3M-4015-1B			
15	XF3M-1515-1B	28	XF3M-2815-1B	41	XF3M-4115-1B			

100pcs per reel

Pins *1	Model	Pins *1	Model	Pins *1	Model	Pins *1	Model	Quantity per reel (unit) *2
4	XF3M-0415-1B-R100	16	XF3M-1615-1B-R100	29	XF3M-2915-1B-R100	42	XF3M-4215-1B-R100	100
5	XF3M-0515-1B-R100	17	XF3M-1715-1B-R100	30	XF3M-3015-1B-R100	45	XF3M-4515-1B-R100	
6	XF3M-0615-1B-R100	18	XF3M-1815-1B-R100	31	XF3M-3115-1B-R100	50	XF3M-5015-1B-R100	
7	XF3M-0715-1B-R100	19	XF3M-1915-1B-R100	32	XF3M-3215-1B-R100	51	XF3M-5115-1B-R100	
8	XF3M-0815-1B-R100	20	XF3M-2015-1B-R100	33	XF3M-3315-1B-R100	53	XF3M-5315-1B-R100	
9	XF3M-0915-1B-R100	21	XF3M-2115-1B-R100	34	XF3M-3415-1B-R100	54	XF3M-5415-1B-R100	
10	XF3M-1015-1B-R100	22	XF3M-2215-1B-R100	35	XF3M-3515-1B-R100	55	XF3M-5515-1B-R100	
11	XF3M-1115-1B-R100	23	XF3M-2315-1B-R100	36	XF3M-3615-1B-R100	57	XF3M-5715-1B-R100	
12	XF3M-1215-1B-R100	24	XF3M-2415-1B-R100	37	XF3M-3715-1B-R100	60	XF3M-6015-1B-R100	
13	XF3M-1315-1B-R100	25	XF3M-2515-1B-R100	38	XF3M-3815-1B-R100	80	XF3M-8015-1BE-R100	
14	XF3M-1415-1B-R100	26	XF3M-2615-1B-R100	40	XF3M-4015-1B-R100			
15	XF3M-1515-1B-R100	28	XF3M-2815-1B-R100	41	XF3M-4115-1B-R100			

Dual-sided Contact Models - Tin-plated

Standard reel

Pins *1	Model	Pins *1	Model	Pins *1	Model	Pins *1	Model	Quantity per reel (unit) *2
(4)	XF3M-0415-1D	(14)	XF3M-1415-1D	(24)	XF3M-2415-1D	(35)	XF3M-3515-1D	1,500
(5)	XF3M-0515-1D	(15)	XF3M-1515-1D	(25)	XF3M-2515-1D	(36)	XF3M-3615-1D	
(6)	XF3M-0615-1D	(16)	XF3M-1615-1D	(26)	XF3M-2615-1D	(37)	XF3M-3715-1D	
(7)	XF3M-0715-1D	(17)	XF3M-1715-1D	(28)	XF3M-2815-1D	(38)	XF3M-3815-1D	
(8)	XF3M-0815-1D	(18)	XF3M-1815-1D	(29)	XF3M-2915-1D	(40)	XF3M-4015-1D	
9	XF3M-0915-1D	(19)	XF3M-1915-1D	(30)	XF3M-3015-1D	(41)	XF3M-4115-1D	
10	XF3M-1015-1D	20	XF3M-2015-1D	(31)	XF3M-3115-1D	(42)	XF3M-4215-1D	
(11)	XF3M-1115-1D	(21)	XF3M-2115-1D	32	XF3M-3215-1D	(45)	XF3M-4515-1D	
(12)	XF3M-1215-1D	(22)	XF3M-2215-1D	(33)	XF3M-3315-1D	(50)	XF3M-5015-1D	
(13)	XF3M-1315-1D	(23)	XF3M-2315-1D	(34)	XF3M-3415-1D			

100pcs per reel

Pins *1	Model	Pins *1	Model	Pins *1	Model	Pins *1	Model	Quantity per reel (unit) *2
(4)	XF3M-0415-1D-R100	(14)	XF3M-1415-1D-R100	(24)	XF3M-2415-1D-R100	(35)	XF3M-3515-1D-R100	100
(5)	XF3M-0515-1D-R100	(15)	XF3M-1515-1D-R100	(25)	XF3M-2515-1D-R100	(36)	XF3M-3615-1D-R100	
(6)	XF3M-0615-1D-R100	(16)	XF3M-1615-1D-R100	(26)	XF3M-2615-1D-R100	(37)	XF3M-3715-1D-R100	
(7)	XF3M-0715-1D-R100	(17)	XF3M-1715-1D-R100	(28)	XF3M-2815-1D-R100	(38)	XF3M-3815-1D-R100	
(8)	XF3M-0815-1D-R100	(18)	XF3M-1815-1D-R100	(29)	XF3M-2915-1D-R100	(40)	XF3M-4015-1D-R100	
(9)	XF3M-0915-1D-R100	(19)	XF3M-1915-1D-R100	(30)	XF3M-3015-1D-R100	(41)	XF3M-4115-1D-R100	
10	XF3M-1015-1D-R100	(20)	XF3M-2015-1D-R100	(31)	XF3M-3115-1D-R100	(42)	XF3M-4215-1D-R100	
(11)	XF3M-1115-1D-R100	(21)	XF3M-2115-1D-R100	(32)	XF3M-3215-1D-R100	(45)	XF3M-4515-1D-R100	
(12)	XF3M-1215-1D-R100	(22)	XF3M-2215-1D-R100	(33)	XF3M-3315-1D-R100	(50)	XF3M-5015-1D-R100	
(13)	XF3M-1315-1D-R100	(23)	XF3M-2315-1D-R100	(34)	XF3M-3415-1D-R100			

Upper-sided Models - Gold-plated (flash)

Standard reel

Pins *1	Model	Pins *1	Model	Pins *1	Model	Pins *1	Model	Quantity per reel (unit) *2
(4)	XF3M-0425-1B	13	XF3M-1325-1B	22	XF3M-2225-1B	(32)	XF3M-3225-1B	1,500
(5)	XF3M-0525-1B	14	XF3M-1425-1B	(23)	XF3M-2325-1B	(33)	XF3M-3325-1B	
6	XF3M-0625-1B	15	XF3M-1525-1B	24	XF3M-2425-1B	(34)	XF3M-3425-1B	
7	XF3M-0725-1B	16	XF3M-1625-1B	25	XF3M-2525-1B	(35)	XF3M-3525-1B	
8	XF3M-0825-1B	17	XF3M-1725-1B	26	XF3M-2625-1B	(36)	XF3M-3625-1B	
9	XF3M-0925-1B	18	XF3M-1825-1B	(28)	XF3M-2825-1B	(37)	XF3M-3725-1B	
10	XF3M-1025-1B	19	XF3M-1925-1B	(29)	XF3M-2925-1B	(38)	XF3M-3825-1B	
11	XF3M-1125-1B	20	XF3M-2025-1B	(30)	XF3M-3025-1B	40	XF3M-4025-1B	
12	XF3M-1225-1B	(21)	XF3M-2125-1B	(31)	XF3M-3125-1B			

XF3M

100pcs per reel

Pins *1	Model	Pins *1	Model	Pins *1	Model	Pins *1	Model	Quantity per reel (unit) *2
(4)	XF3M-0425-1B-R100	(13)	XF3M-1325-1B-R100	(22)	XF3M-2225-1B-R100	(32)	XF3M-3225-1B-R100	100
(5)	XF3M-0525-1B-R100	(14)	XF3M-1425-1B-R100	(23)	XF3M-2325-1B-R100	(33)	XF3M-3325-1B-R100	
(6)	XF3M-0625-1B-R100	(15)	XF3M-1525-1B-R100	(24)	XF3M-2425-1B-R100	(34)	XF3M-3425-1B-R100	
(7)	XF3M-0725-1B-R100	(16)	XF3M-1625-1B-R100	(25)	XF3M-2525-1B-R100	(35)	XF3M-3525-1B-R100	
(8)	XF3M-0825-1B-R100	(17)	XF3M-1725-1B-R100	(26)	XF3M-2625-1B-R100	(36)	XF3M-3625-1B-R100	
(9)	XF3M-0925-1B-R100	(18)	XF3M-1825-1B-R100	(28)	XF3M-2825-1B-R100	(37)	XF3M-3725-1B-R100	
(10)	XF3M-1025-1B-R100	(19)	XF3M-1925-1B-R100	(29)	XF3M-2925-1B-R100	(38)	XF3M-3825-1B-R100	
(11)	XF3M-1125-1B-R100	(20)	XF3M-2025-1B-R100	(30)	XF3M-3025-1B-R100	(40)	XF3M-4025-1B-R100	
(12)	XF3M-1225-1B-R100	(21)	XF3M-2125-1B-R100	(31)	XF3M-3125-1B-R100			

*1. Please consult your OMRON representative for available pin count.

*2. Please order by integer multiple of the quantity per reel.

Dimensions

CAD Data

Please visit our website, which is noted on the last page.

(Unit: mm)

XF3M-□□15-1B
 XF3M-□□15-1D
 XF3M-□□15-1BE
 XF3M-□□25-1B

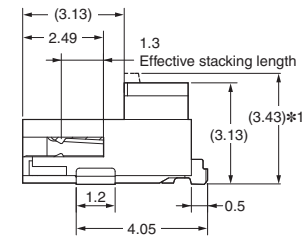
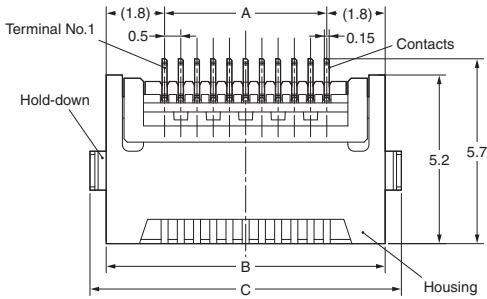

Model with dual-sided contacts
Unlocked

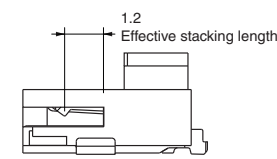
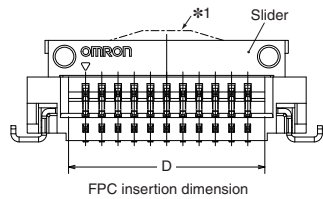

Model with single-sided contacts (upper sided) *2
Unlocked

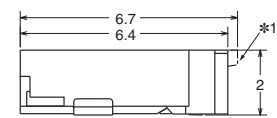

Locked

PCB Dimensions (TOP VIEW)

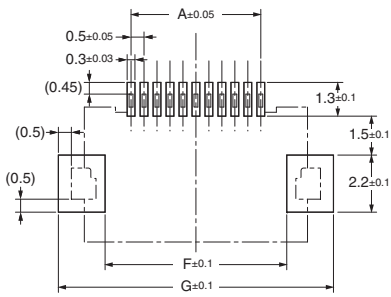

Recommended FPC/FFC Dimensions

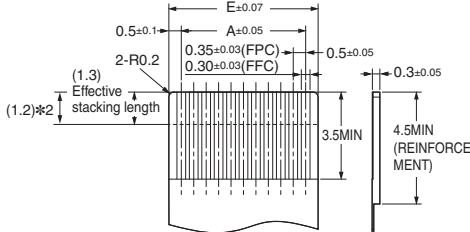

CAD Data

*1. Dotted lines indicate the shape and dimensions of the XF3M-8015-1BE Connectors.

*2. For the XF3M-□□25-1B Connectors.

Table of Dimension

Pins	A	B	C	D	E	F	G
4	1.5	5.1	6.1	2.55	2.5	3.5	7.1
5	2.0	5.6	6.6	3.05	3.0	4.0	7.6
6	2.5	6.1	7.1	3.55	3.5	4.5	8.1
7	3.0	6.6	7.6	4.05	4.0	5.0	8.6
8	3.5	7.1	8.1	4.55	4.5	5.5	9.1
9	4.0	7.6	8.6	5.05	5.0	6.0	9.6
10	4.5	8.1	9.1	5.55	5.5	6.5	10.1
11	5.0	8.6	9.6	6.05	6.0	7.0	10.6
12	5.5	9.1	10.1	6.55	6.5	7.5	11.1
13	6.0	9.6	10.6	7.05	7.0	8.0	11.6
14	6.5	10.1	11.1	7.55	7.5	8.5	12.1
15	7.0	10.6	11.6	8.05	8.0	9.0	12.6
16	7.5	11.1	12.1	8.55	8.5	9.5	13.1
17	8.0	11.6	12.6	9.05	9.0	10.0	13.6
18	8.5	12.1	13.1	9.55	9.5	10.5	14.1
19	9.0	12.6	13.6	10.05	10.0	11.0	14.6
20	9.5	13.1	14.1	10.55	10.5	11.5	15.1
21	10.0	13.6	14.6	11.05	11.0	12.0	15.6
22	10.5	14.1	15.1	11.55	11.5	12.5	16.1
23	11.0	14.6	15.6	12.05	12.0	13.0	16.6
24	11.5	15.1	16.1	12.55	12.5	13.5	17.1
25	12.0	15.6	16.6	13.05	13.0	14.0	17.6
26	12.5	16.1	17.1	13.55	13.5	14.5	18.1
28	13.5	17.1	18.1	14.55	14.5	15.5	19.1
29	14.0	17.6	18.6	15.05	15.0	16.0	19.6
30	14.5	18.1	19.1	15.55	15.5	16.5	20.1
31	15.0	18.6	19.6	16.05	16.0	17.0	20.6
32	15.5	19.1	20.1	16.55	16.5	17.5	21.1
33	16.0	19.6	20.6	17.05	17.0	18.0	21.6
34	16.5	20.1	21.1	17.55	17.5	18.5	22.1
35	17.0	20.6	21.6	18.05	18.0	19.0	22.6
36	17.5	21.1	22.1	18.55	18.5	19.5	23.1
37	18.0	21.6	22.6	19.05	19.0	20.0	23.6
38	18.5	22.1	23.1	19.55	19.5	20.5	24.1
40	19.5	23.1	24.1	20.55	20.5	21.5	25.1
41	20.0	23.6	24.6	21.05	21.0	22.0	25.6
42	20.5	24.1	25.1	21.55	21.5	22.5	26.1
45	22.0	25.6	26.6	23.05	23.0	24.0	27.6
50	24.5	28.1	29.1	25.55	25.5	26.5	30.1
51	25.0	28.6	29.6	26.05	26.0	27.0	30.6
53	26.0	29.6	30.6	27.05	27.0	28.0	31.6
54	26.5	30.1	31.1	27.55	27.5	28.5	32.1
55	27.0	30.6	31.6	28.05	28.0	29.0	32.6
57	28.0	31.6	32.6	29.05	29.0	30.0	33.6
60	29.5	33.1	34.1	30.55	30.5	31.5	35.1
80	39.5	43.1	44.1	40.55	40.5	41.5	45.1

XF3M(1) 1.0-mm pitch model

Ordering Information

Dual-sided Contact Models - Gold-plated (flash)

Standard reel

Pins *1	Model	Pins *1	Model	Pins *1	Model	Pins *1	Model	Quantity per reel (unit) *2
4	XF3M(1)-0415-1B	10	XF3M(1)-1015-1B	(17)	XF3M(1)-1715-1B	25	XF3M(1)-2515-1B	1,500
5	XF3M(1)-0515-1B	11	XF3M(1)-1115-1B	18	XF3M(1)-1815-1B	26	XF3M(1)-2615-1B	
6	XF3M(1)-0615-1B	12	XF3M(1)-1215-1B	20	XF3M(1)-2015-1B	28	XF3M(1)-2815-1B	
7	XF3M(1)-0715-1B	14	XF3M(1)-1415-1B	22	XF3M(1)-2215-1B	30	XF3M(1)-3015-1B	
8	XF3M(1)-0815-1B	15	XF3M(1)-1515-1B	23	XF3M(1)-2315-1B	32	XF3M(1)-3215-1B	
9	XF3M(1)-0915-1B	16	XF3M(1)-1615-1B	(24)	XF3M(1)-2415-1B			

100pcs per reel

Pins *1	Model	Pins *1	Model	Pins *1	Model	Pins *1	Model	Quantity per reel (unit) *2
4	XF3M(1)-0415-1B-R100	10	XF3M(1)-1015-1B-R100	(17)	XF3M(1)-1715-1B-R100	(25)	XF3M(1)-2515-1B-R100	100
5	XF3M(1)-0515-1B-R100	11	XF3M(1)-1115-1B-R100	18	XF3M(1)-1815-1B-R100	26	XF3M(1)-2615-1B-R100	
6	XF3M(1)-0615-1B-R100	12	XF3M(1)-1215-1B-R100	20	XF3M(1)-2015-1B-R100	(28)	XF3M(1)-2815-1B-R100	
7	XF3M(1)-0715-1B-R100	14	XF3M(1)-1415-1B-R100	22	XF3M(1)-2215-1B-R100	30	XF3M(1)-3015-1B-R100	
8	XF3M(1)-0815-1B-R100	15	XF3M(1)-1515-1B-R100	23	XF3M(1)-2315-1B-R100	(32)	XF3M(1)-3215-1B-R100	
9	XF3M(1)-0915-1B-R100	16	XF3M(1)-1615-1B-R100	(24)	XF3M(1)-2415-1B-R100			

Dual-sided Contact Models - Tin-plated

Standard reel

Pins *1	Model	Pins *1	Model	Pins *1	Model	Pins *1	Model	Quantity per reel (unit) *2
(4)	XF3M(1)-0415-1D	10	XF3M(1)-1015-1D	(17)	XF3M(1)-1715-1D	(25)	XF3M(1)-2515-1D	1,500
(5)	XF3M(1)-0515-1D	(11)	XF3M(1)-1115-1D	18	XF3M(1)-1815-1D	(26)	XF3M(1)-2615-1D	
6	XF3M(1)-0615-1D	12	XF3M(1)-1215-1D	20	XF3M(1)-2015-1D	(28)	XF3M(1)-2815-1D	
(7)	XF3M(1)-0715-1D	(14)	XF3M(1)-1415-1D	22	XF3M(1)-2215-1D	(30)	XF3M(1)-3015-1D	
8	XF3M(1)-0815-1D	(15)	XF3M(1)-1515-1D	(23)	XF3M(1)-2315-1D	(32)	XF3M(1)-3215-1D	
9	XF3M(1)-0915-1D	(16)	XF3M(1)-1615-1D	(24)	XF3M(1)-2415-1D			

100pcs per reel

Pins *1	Model	Pins *1	Model	Pins *1	Model	Pins *1	Model	Quantity per reel (unit) *2
(4)	XF3M(1)-0415-1D-R100	10	XF3M(1)-1015-1D-R100	(17)	XF3M(1)-1715-1D-R100	(25)	XF3M(1)-2515-1D-R100	100
(5)	XF3M(1)-0515-1D-R100	(11)	XF3M(1)-1115-1D-R100	(18)	XF3M(1)-1815-1D-R100	(26)	XF3M(1)-2615-1D-R100	
(6)	XF3M(1)-0615-1D-R100	(12)	XF3M(1)-1215-1D-R100	(20)	XF3M(1)-2015-1D-R100	(28)	XF3M(1)-2815-1D-R100	
(7)	XF3M(1)-0715-1D-R100	(14)	XF3M(1)-1415-1D-R100	(22)	XF3M(1)-2215-1D-R100	(30)	XF3M(1)-3015-1D-R100	
(8)	XF3M(1)-0815-1D-R100	(15)	XF3M(1)-1515-1D-R100	(23)	XF3M(1)-2315-1D-R100	(32)	XF3M(1)-3215-1D-R100	
(9)	XF3M(1)-0915-1D-R100	(16)	XF3M(1)-1615-1D-R100	(24)	XF3M(1)-2415-1D-R100			

*1. Please consult your OMRON representative for available pin count.
 *2. Please order by integer multiple of the quantity per reel.

Dimensions

CAD Data

Please visit our website, which is noted on the last page.

(Unit: mm)

XF3M(1)-□□15-1B XF3M(1)-□□15-1D

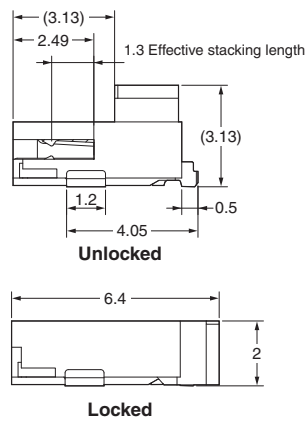
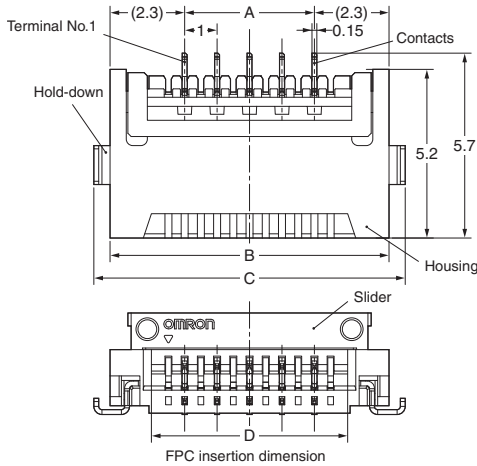
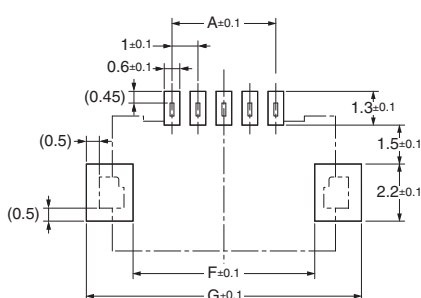

Table of Dimensions

Pins	A	B	C	D	E	F	G
4	3.0	7.6	8.6	5.05	5.0	6.0	9.6
5	4.0	8.6	9.6	6.05	6.0	7.0	10.6
6	5.0	9.6	10.6	7.05	7.0	8.0	11.6
7	6.0	10.6	11.6	8.05	8.0	9.0	12.6
8	7.0	11.6	12.6	9.05	9.0	10.0	13.6
9	8.0	12.6	13.6	10.05	10.0	11.0	14.6
10	9.0	13.6	14.6	11.05	11.0	12.0	15.6
11	10.0	14.6	15.6	12.05	12.0	13.0	16.6
12	11.0	15.6	16.6	13.05	13.0	14.0	17.6
14	13.0	17.6	18.6	15.05	15.0	16.0	19.6
15	14.0	18.6	19.6	16.05	16.0	17.0	20.6
16	15.0	19.6	20.6	17.05	17.0	18.0	21.6
17	16.0	20.6	21.6	18.05	18.0	19.0	22.6
18	17.0	21.6	22.6	19.05	19.0	20.0	23.6
20	19.0	23.6	24.6	21.05	21.0	22.0	25.6
22	21.0	25.6	26.6	23.05	23.0	24.0	27.6
23	22.0	26.6	27.6	24.05	24.0	25.0	28.6
24	23.0	27.6	28.6	25.05	25.0	26.0	29.6
25	24.0	28.6	29.6	26.05	26.0	27.0	30.6
26	25.0	29.6	30.6	27.05	27.0	28.0	31.6
28	27.0	31.6	32.6	29.05	29.0	30.0	33.6
30	29.0	33.6	34.6	31.05	31.0	32.0	35.6
32	31.0	35.6	36.6	33.05	33.0	34.0	37.6

PCB Dimensions (TOP VIEW)



Recommended FPC/FFC Dimensions

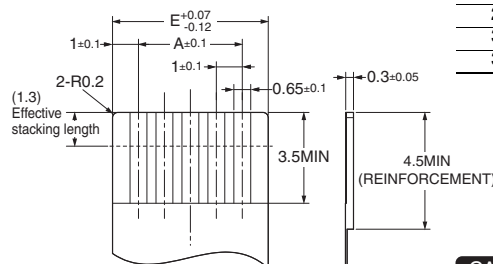

CAD Data

Rotary Backlock Connectors Provide High-reliability and Superior Work Efficiency.

- Dual-sided contact reduces the number of parts.
- Applicable FPC/FFC thickness of 0.3 mm (Gold-plated type).
- Halogen Free (*)

* OMRON uses the following standard to determine halogen-free construction: 900 ppm max. for Br, 900 ppm max. for Cl, and 1,500 ppm max. for Br+Cl.

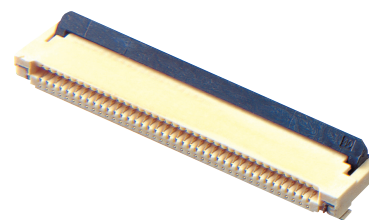

Ratings and Specifications

Rated current	0.5 A AC/DC
Rated voltage	50 V AC/DC
Contact resistance	50 mΩ max. (at 20 mV DC max., 100 mA max.)
Insulation resistance	100 MΩ min. (at 250 V DC)
Dielectric strength	250 V AC for 1 min. (leakage current: 1 mA max.)
Insertion durability	20 times
Ambient operating temperature	-30 to 85 °C (With no icing or condensation)

Materials and Finish

Housing	LCP resin (UL94 V-0)/natural
Slider	LCP resin (UL94 V-0)/black
Contacts	Spring copper alloy/nickel substrate (2 μm) Gold-plated contacts (0.15 μm)
Hold-down	Copper alloy/tin-plated (1.5 μm)

Ordering Information

Standard reel

Pins	Model	Pins	Model	Pins	Model	Pins	Model	Quantity per reel (unit) *1
6	XF2M-0615-1A	22	XF2M-2215-1A	35	XF2M-3515-1A	54	XF2M-5415-1AH	1,500
8	XF2M-0815-1A	24	XF2M-2415-1A	36	XF2M-3615-1A	55	XF2M-5515-1AH	
10	XF2M-1015-1A	26	XF2M-2615-1A	38	XF2M-3815-1A	60	XF2M-6015-1AH	
12	XF2M-1215-1A	30	XF2M-3015-1A	40	XF2M-4015-1A			
14	XF2M-1415-1A	32	XF2M-3215-1A	42	XF2M-4215-1A			
18	XF2M-1815-1A	33	XF2M-3315-1A	45	XF2M-4515-1A			
20	XF2M-2015-1A	34	XF2M-3415-1A	50	XF2M-5015-1A			

100pcs per reel

Pins	Model	Pins	Model	Pins	Model	Pins	Model	Quantity per reel (unit) *1
6	XF2M-0615-1A-R100	22	XF2M-2215-1A-R100	35	XF2M-3515-1A-R100	54	XF2M-5415-1AH-R100	100
8	XF2M-0815-1A-R100	24	XF2M-2415-1A-R100	36	XF2M-3615-1A-R100	55	XF2M-5515-1AH-R100	
10	XF2M-1015-1A-R100	26	XF2M-2615-1A-R100	38	XF2M-3815-1A-R100	60	XF2M-6015-1AH-R100	
12	XF2M-1215-1A-R100	30	XF2M-3015-1A-R100	40	XF2M-4015-1A-R100			
14	XF2M-1415-1A-R100	32	XF2M-3215-1A-R100	42	XF2M-4215-1A-R100			
18	XF2M-1815-1A-R100	33	XF2M-3315-1A-R100	45	XF2M-4515-1A-R100			
20	XF2M-2015-1A-R100	34	XF2M-3415-1A-R100	50	XF2M-5015-1A-R100			

*1. Please order by integer multiple of the quantity per reel.

Dimensions

CAD Data

Please visit our website, which is noted on the last page.

(Unit: mm)

XF2M-□□15-1A
XF2M-□□15-1AH

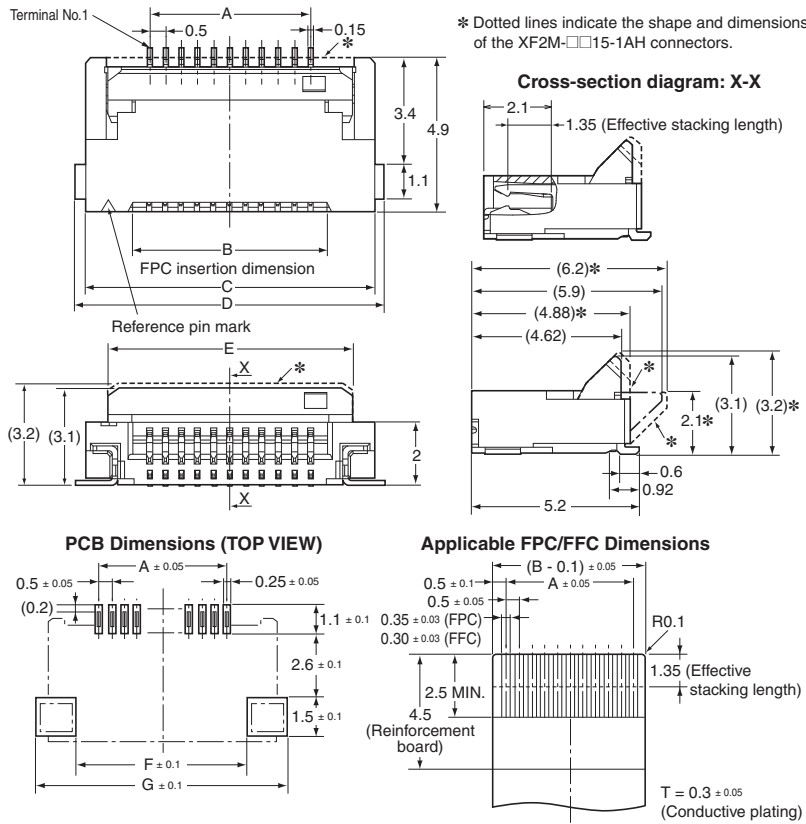

Table of Dimensions

Pins	Model	A	B	C	D	E	F	G
6	XF2M-0615-1A	2.5	3.6	6.5	7.1	5.1	4.1	7.5
8	XF2M-0815-1A	3.5	4.6	7.5	8.1	6.1	5.1	8.5
10	XF2M-1015-1A	4.5	5.6	8.5	9.1	7.1	6.1	9.5
12	XF2M-1215-1A	5.5	6.6	9.5	10.1	8.1	7.1	10.5
14	XF2M-1415-1A	6.5	7.6	10.5	11.1	9.1	8.1	11.5
18	XF2M-1815-1A	8.5	9.6	12.5	13.1	11.1	10.1	13.5
20	XF2M-2015-1A	9.5	10.6	13.5	14.1	12.1	11.1	14.5
22	XF2M-2215-1A	10.5	11.6	14.5	15.1	13.1	12.1	15.5
24	XF2M-2415-1A	11.5	12.6	15.5	16.1	14.1	13.1	16.5
26	XF2M-2615-1A	12.5	13.6	16.5	17.1	15.1	14.1	17.5
30	XF2M-3015-1A	14.5	15.6	18.5	19.1	17.1	16.1	19.5
32	XF2M-3215-1A	15.5	16.6	19.5	20.1	18.1	17.1	20.5
33	XF2M-3315-1A	16.0	17.1	20.0	20.6	18.6	17.6	21.0
34	XF2M-3415-1A	16.5	17.6	20.5	21.1	19.1	18.1	21.5
35	XF2M-3515-1A	17.0	18.1	21.0	21.6	19.6	18.6	22.0
36	XF2M-3615-1A	17.5	18.6	21.5	22.1	20.1	19.1	22.5
38	XF2M-3815-1A	18.5	19.6	22.5	23.1	21.1	20.1	23.5
40	XF2M-4015-1A	19.5	20.6	23.5	24.1	22.1	21.1	24.5
42	XF2M-4215-1A	20.5	21.6	24.5	25.1	23.1	22.1	25.5
45	XF2M-4515-1A	22.0	23.1	26.0	26.6	24.6	23.6	27.0
50	XF2M-5015-1A	24.5	25.6	28.5	29.1	27.1	26.1	29.5
54	XF2M-5415-1AH	26.5	27.6	30.5	31.1	29.1	28.1	31.5
55	XF2M-5515-1AH	27.0	28.1	31.0	31.6	29.6	28.6	32.0
60	XF2M-6015-1AH	29.5	30.6	33.5	34.1	32.1	31.1	34.5

CAD Data

Common Precautions for XF Connectors

Precautions

Precautions for Correct Use

For Mounting

- When mounting the connector by manual soldering, observe the following precautions to ensure contact reliability.
 - Conditions for manual soldering: 350±10 °C 3±1 sec
 - Do not apply an excessive amount of solder. Excessive solder will cause the flux to rise.
 - Do not apply the soldering iron to the mount attachments using force. Doing so may cause the connectors to change shape.
 - Do not apply the soldering iron to any parts of the connector other than the mount attachments. Doing so may cause the connector to change shape.
- There are case that the following phenomenon is sometimes occurred. However there are no bad influences to functions and performance of the connector.
 - Occurrence of black spot to plastic parts
 - Occurrence of a weld line to plastic parts
 - Occurrence of the blister to the plastic parts
 - Occurrence of discoloration to plating parts of terminal and hold-down or plastic parts of slider after reflow.
- Be careful of board warping. The connector flatness is 0.1 mm max. A large amount of warping, however, may result in soldering faults.

- Do not apply excessive force on the connector before mounting it. The connector may be damaged, resulting in faulty contacts. Do not insert the FPC/FFC and lock the slider before mounting the connector.
- Be careful not to apply an excessive load on the board when performing the following actions. The connector may be damaged, resulting in faulty contacts.
 - Dividing multi-cavity boards.
 - Securing a board with screws.

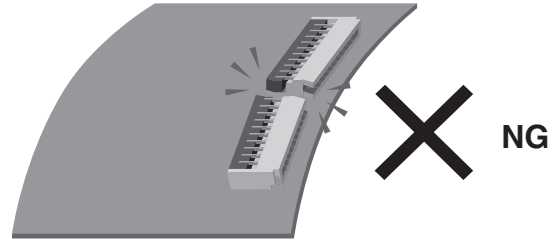

Storage

- Do not store the connectors in locations subject to dust or high humidity.
- Do not store the connectors in locations close to sources of gasses such ammonia gas or sulfide gas.

Approval Standard

The approval rating values for overseas standards are different from the performance values determined individually. Confirm the values before use.

Model	Standard	File No.	Rating
XF3M-□□15-1B	Non Approved Models	---	---
XF3M-8015-1BE	Non Approved Models	---	---
XF3M-□□15-1B-R100	Non Approved Models	---	---
XF3M-8015-1BE-R100	Non Approved Models	---	---
XF3M-□□15-1D	Non Approved Models	---	---
XF3M-□□15-1D-R100	Non Approved Models	---	---
XF3M-□□25-1B	Non Approved Models	---	---
XF3M-□□25-1B-R100	Non Approved Models	---	---
XF3M(1)-□□15-1B	Non Approved Models	---	---
XF3M(1)-□□15-1B-R100	Non Approved Models	---	---
XF3M(1)-□□15-1D	Non Approved Models	---	---
XF3M(1)-□□15-1D-R100	Non Approved Models	---	---
XF2M-□□15-1A	Non Approved Models	---	---
XF2M-□□15-1AH	Non Approved Models	---	---
XF2M-□□15-1A-R100	Non Approved Models	---	---
XF2M-□□15-1AH-R100	Non Approved Models	---	---
XY3F-□□01-□□□	Non Approved Models	---	---

Operating the XF Rotary Backlock

FPC/FFC connector parts

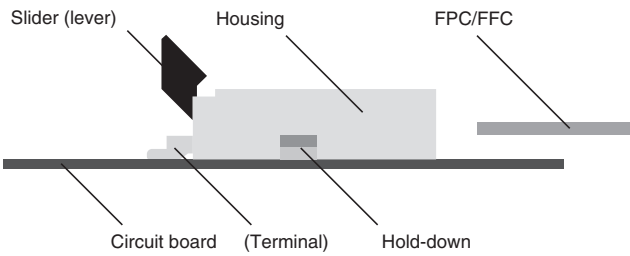

Handling Methods

For Inserting the FPC/FFC

1. Insert the FPC/FFC fully to the back of the connector.

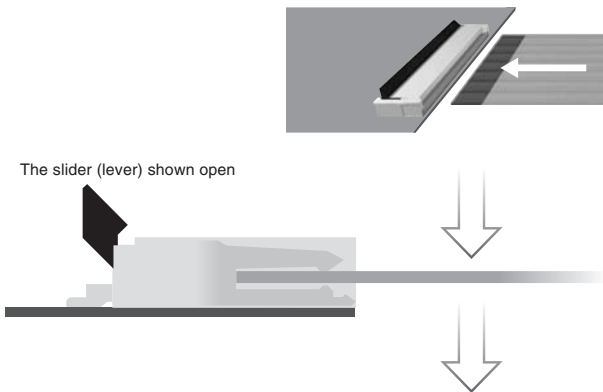

The slider (lever) shown open

2. Activate the slider (lever) and lock the FPC/FFC in place.

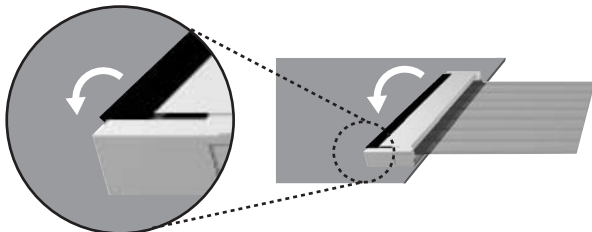

The slider (lever) shown locked

For removing the FPC/FFC

1. Move the slider (lever) upwards to disengage the locking mechanism.

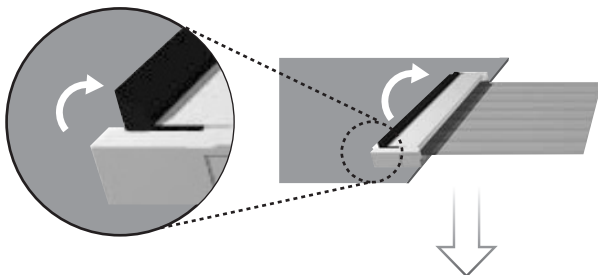

2. Once the lock has been disengaged, pull the FPC/FFC out.

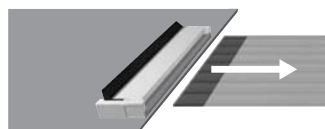

Precautions during Use

For Operating

1. Insert the FPC/FFC fully to the back of the connector to ensure contact reliability.
2. Do not lock the slider (lever) without an FPC/FFC inserted. Locking the slider (lever) without an FPC/FFC inserted will increase the force required to insert an FPC/FFC.

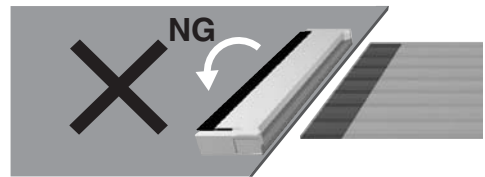
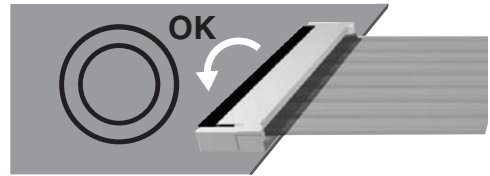

3. Do not lock or unlock the slider (lever) with excessive force. The connector may be damaged, resulting in faulty contacts. Do not use the slider (lever) again if it becomes detached.
4. When locking the slider (lever), apply pressure with your fingertips to both sides of the slider (lever) and then twist the slider (lever) until it comes away from the unit. Failing to lock the slider (lever) properly may result in contact failure.

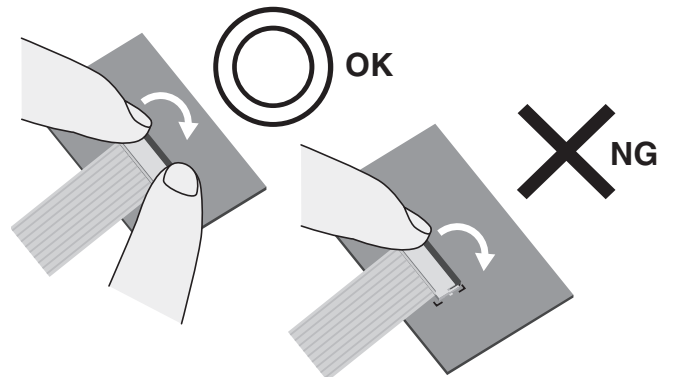

Do not apply force horizontally to the PCB when locking the slider (lever).

The connector may be damaged, resulting in faulty contacts.

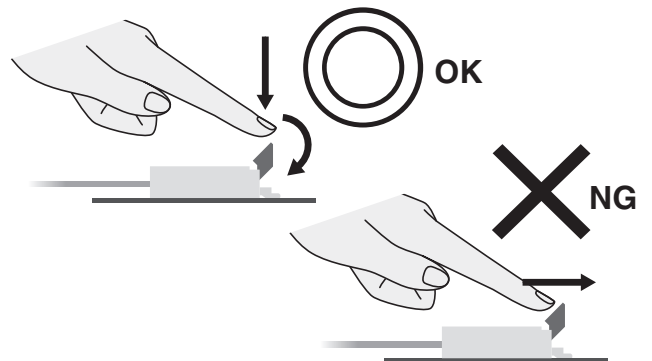

Common Precautions for XF Connectors

5. When unlocking the slider (lever), place your fingers on either side or the entire slider (lever) and slowly lift the slider (lever) up and away.

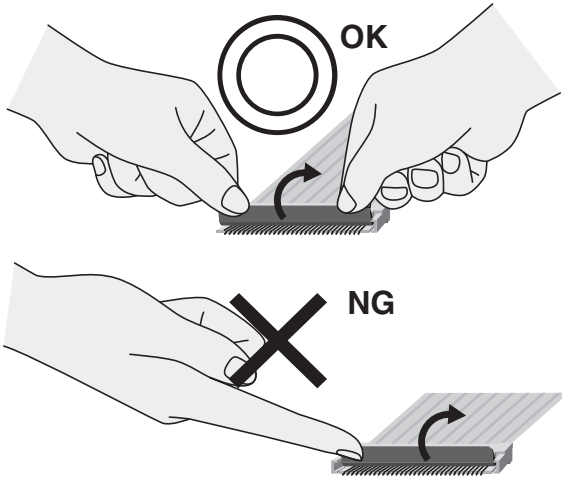

Do not engage the slider past its initial location during the unlocking process. The connector may be damaged, resulting in faulty contacts.

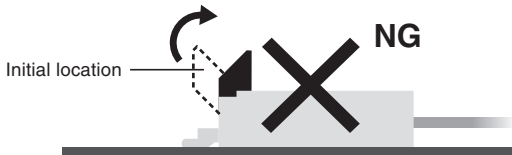

Performing the following action may cause the terminals to change shape or otherwise cause contact failures.

- Using tweezers to unlock the slider (lever).

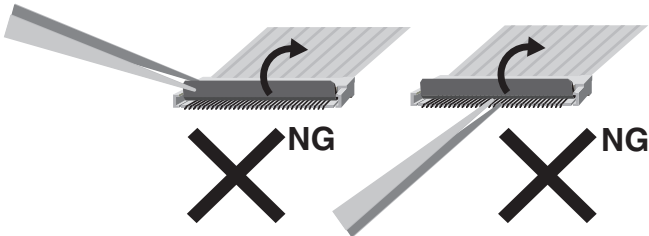

6. When inserting and drawing out the FPC/FFC, be sure to check that the slider (lever) has been unlocked first.

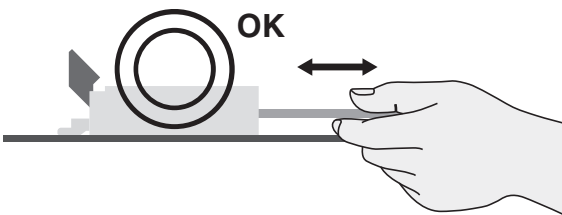

Using the FPC/FFC in the following ways may damage the FPC/FFC, change the shape of the contacts, or result in contact failure.

- Drawing out the FPC/FFC when the slider (lever) is still locked.

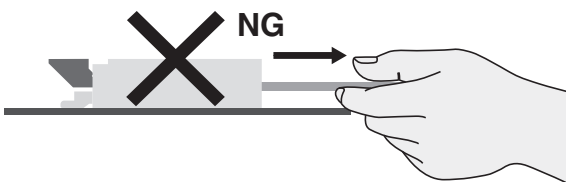

- Drawing out the FPC/FFC by pulling it up and down or from left to right or twisting it sideways.

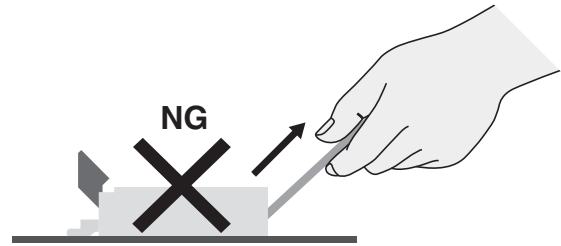

7. Make sure that the FPC/FFC has been inserted correctly. If the FPC/FFC is inserted incorrectly from the customer's design specification, the pin number will not match and it may damage the contacts or cause malfunction of the equipment.

For Mounting

1. Do not perform reflow or manual soldering with the FPC/FFC inserted in the connector and the slider (lever) in the locked position. Doing so may result in contact failure.
2. The reflow conditions are as stated in OMRON's specifications and guidelines. These conditions, however, depend on the type of solder, the manufacturer, the amount of solder, the size of the circuit board, and the other mounting materials.

For Designing

1. Design the FPC/FFC so that extreme peel force should not be applied directly on to the connector. If the FPC/FFC bends near the connector, or if the FPC/FFC is used with extreme peel force directly on to the connector, it may cause a contact loss.
2. If the FPC/FFC is installed at a location or in any equipment that will subject the FPC/FFC to continuous shake or movement, secure the FPC/FFC.
3. Use FPC/FFCs that conform to the appropriate specifications and size as stated or recommended by OMRON. When using a different FPC, or an FFC, contact OMRON.
4. Use the same metal for the FPC/FFC plating and the connector plating.
5. "Whiskers" may protrude from the FPC/FFC film of some lead-free FPC/FFCs. Be careful when using these units.
6. When designing the board, be sure to allow locking and operating space for the slider (lever).

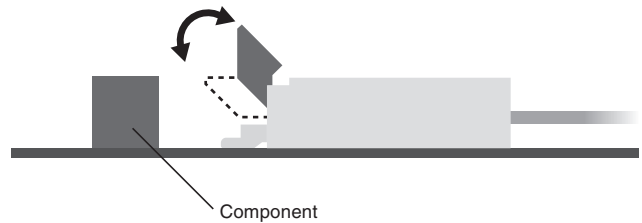

7. Make sure that the metal mask thickness is within the appropriate specifications and size as stated by OMRON. The recommended metal mask open area is 90% of the printed circuit board mating dimensions given in the dimensions diagrams.

Please check each region's Terms & Conditions by region website.

OMRON Corporation

Device & Module Solutions Company

Regional Contact

Americas

<https://components.omron.com/us>

Asia-Pacific

<https://components.omron.com/ap>

Korea

<https://components.omron.com/kr>

Europe

<https://components.omron.com/eu>

China

<https://components.omron.com.cn>

Japan

<https://components.omron.com/jp>