

Transfer or duplication of this document as well as the utilization or communication of its contents are prohibited unless explicit authorization is granted. Violations will be liable for compensation. All rights reserved for patent, utility model or design registrations. 除专利与外观设计、商标、实用新型、发明专利等权利外，本公司保留其他所有权利。

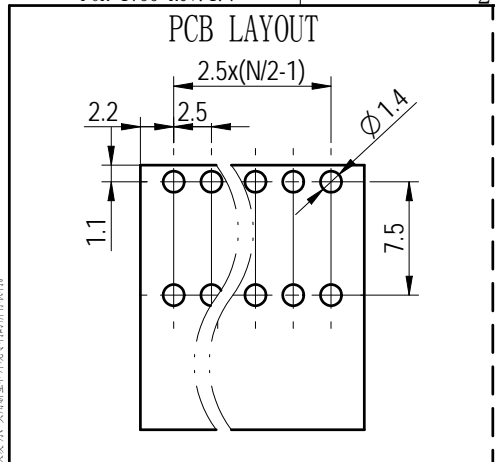

Poles	Curvature (mm)
04-12P	≤0.35
14-18P	≤0.45
20-24P	≤0.50

未注公差/General tolerances (mm)														
0	>3	>6	>10	>18	>30	>50	>80	>120	>180	>250	>315	>400	>500	0.1/10
~	~	~	~	~	~	~	~	~	~	~	~	~	~	∠
±0.12	±0.18	±0.22	±0.26	±0.31	±0.37	±0.57	±0.80	±0.93	±1.05	±1.15	±1.60	±2.20	±2.50	±2°

ITEM	NAME OF PART	MATERIAL	NOTES
4	Pin 2	Copper alloy	Sn Plated
3	Housing	PA66	UL94V-0
2	Pin1	Copper alloy	Sn Plated
1	Cover	PA66	UL94V-0

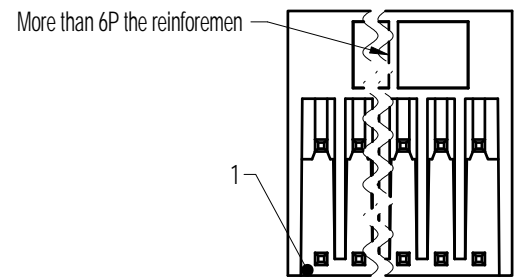
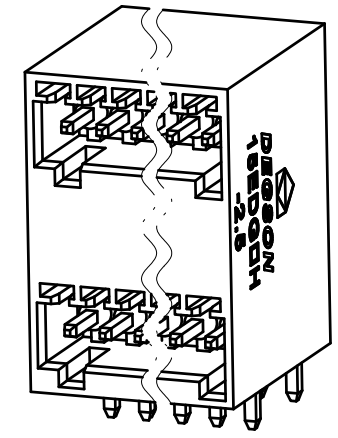
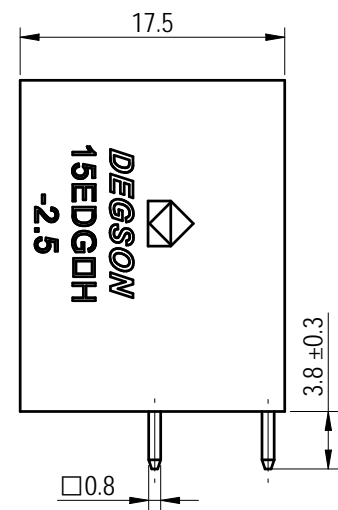
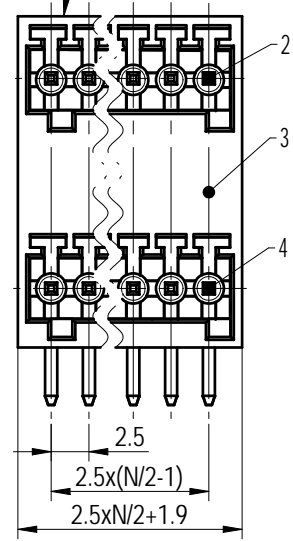
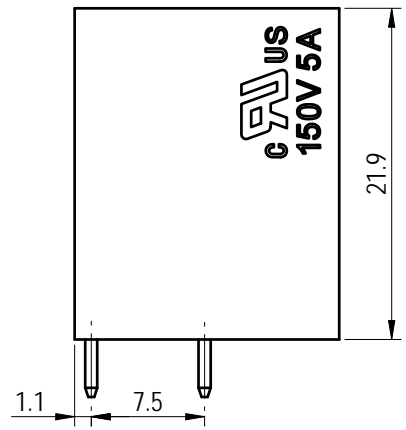
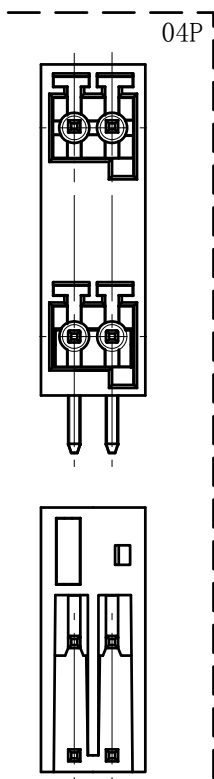

Note:
The A&Z (H) in the name means: A(H) and Z(H).

UL 标准/UL Standard:	B	C	D
额定电压/电流/Rated Voltage(V)/Current(A)	150/5	/	/
IEC 标准/IEC Standard:			
过压类别/Overvoltage Category/污染等级/Pollution Degree	III/3	III/2	II/2
额定电压/电流/Rated Voltage(V)/Current(A)	/	/	100/4
额定脉冲电压(KV)/Rate Impulse Voltage(KV)	/	/	2.5
间距/Pitch(mm)/线数范围/Poles	2.5/N=04~24P		
使用温度范围/Operating temperature(°C)	-40~+105		
符合RoHS环保要求/Conform to RoHS	Yes		
标准颜色编号/Standard color number: PANTONE / RAL	/		

DEGSON		MATERIAL:	SURFACE/COLOR:		
APPD: 兰春华	2023.01.05	MAT NO./REV:	/ 00		
CHKD: 陈招	2023.01.04	NAME	15EDGRH-2.5-XXP-1Y-00A&Z(H)		
DRFT: 刘强	2023.01.04	DRAWING NO.	TYPE	DRAWING STATUS	SCALE
⑥	④	A4	200029813	CUSTOMER DRAWING	已发布
		SHEET	1/1		

REV	ECN	DESCRIPTION	DRFT	DATE
00			刘强	2023.01.04