

XZ-LK60B-171035-B

Built-in non isolated adjustable power color temperature LED driver
Flicker free LED driver
Output current 200mA;250mA;300mA;350mA
Max. output power 61.2W
Nominal life-time up to 50,000 hrs
For illuminates of protection class I
5-year warranty

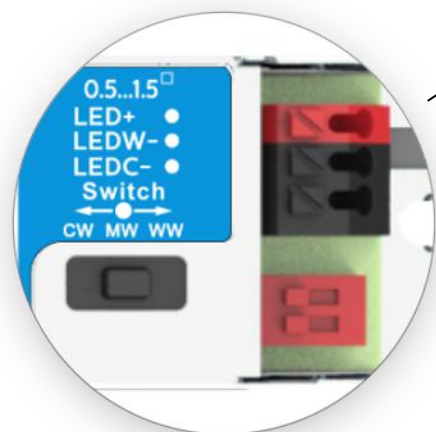

Power & CCT Tunable Series



ELECTRICAL SPECIFICATIONS

Rated input voltage range:	220 ... 240 [Vac]
Continuous input voltage range:	198 ... 264 [Vac]
Rated frequency range:	50/60 [Hz]
Max input current:	0.36A @230Vac
Total harmonic distortion (max.):	≤ 20 %, at rated input voltage range @ full load
Inrush current:	≤30A at Rated input voltage range@ full load
Output current tolerance:	± 5%, at rated input voltage range @ rated load
Turn-on Delay time:	≤ 0.5s at full load @low rated input voltage



No Load Output voltage:	≤ 350Vdc
ripple output current:	≤ 5%
Withstand voltage:	I/P-GND:1.5KVac,<5mA 60S; O/P-GND:1.5KVac,<5mA 60S;
Mains surge immunity:	L-N 1KV ; L-GND:2KV ; N-GND:2KV;
Type:	90° push-in terminal
Wire cross section:	Input and output wire:0.5-1.5mm ² ;
Wire stripping length:	7-8mm
Protection:	Over voltage protection:Hiccup mode.Protection will trigger when load voltage exceed specified output voltage and will auto recover after the fault mode is removed.
	Short circuit protection:Hiccup mode.Protection will trigger when short circuit and will auto recover after the fault mode is removed.
Protection rating	IP 20
Special instructions	<ol style="list-style-type: none"> 1. It is recommended that customers install under-voltage protection and surge protection devices in the power supply circuit of lamps to ensure the safety of electricity consumption 2. The power supply is used in combination with the terminal equipment as a part of the whole lamp. Because the EMC performance is affected by LED lamps and wiring, the terminal is set in case the manufacturer needs to reconfirm the EMC of the whole device 3. The outputs of drivers cannot be in paralleled.

ENVIRONMENTAL SPECIFICATIONS

Operating temperature:	-20 to 50°C
Storage temperature:	-40 to 80°C
Working Humidity:	10% to 90%
Store Humidity:	5% to 90%
Driver Lifetime:	at tc=75°C , 50000 hrs;
Maximum Tcase Temperature :	85°C

PRODUCT SPECIFICATIONS

Model Number(Full Model)	Output Current	Input Voltage	Output Voltage	Efficiency @full load	Current Accuracy	Power Factor	Dimension L*W*H(mm)
XZ-LK60B-171035-B	200mA	220-240Vac	90-175Vdc	90%	±5%	≥0.9	L193*W30*H21
	250mA			91%			
	300mA			91%			
	350mA			91%			

SAFETY AND EMC COMPLIANCE

ENEC+ CE	EN 61347-2-13:2014/A1:2017	CCC	GB17625.1-2012	SAA	AS/NZS IEC 61347.2.13.2013
	EN 61347-1:2015		GB/T17743-2017		AS/NZS 61347.1:2016
	EN 62384:2006/A1:2009		GB/19510.1-2009		
	EN 55015:2013/A1:2015		GB19510.14-2009		
	EN61000-3-2:2014				
	EN61000-3-3:2013				
	EN61547:2009				

PHYSICAL DIMENSIONS

Length (L):	7.6" (193mm)
Width (W):	1.18" (30mm)
Height (H):	0.826" (21mm)

PACKAGING

0.134 kg / unit	60pcs / carton
Carton size:	313 x 203 x 160 mm
Carton weight:	8.5 kg

Tel:+86-755-27819400 Fax:+86-755-27819401

Add:Floor 6, building C, guangxingyuan Internet intelligent technology park, xin'an fourth road, baoan 74 district, shenzhen

SHELL STRUCTURE SIZE

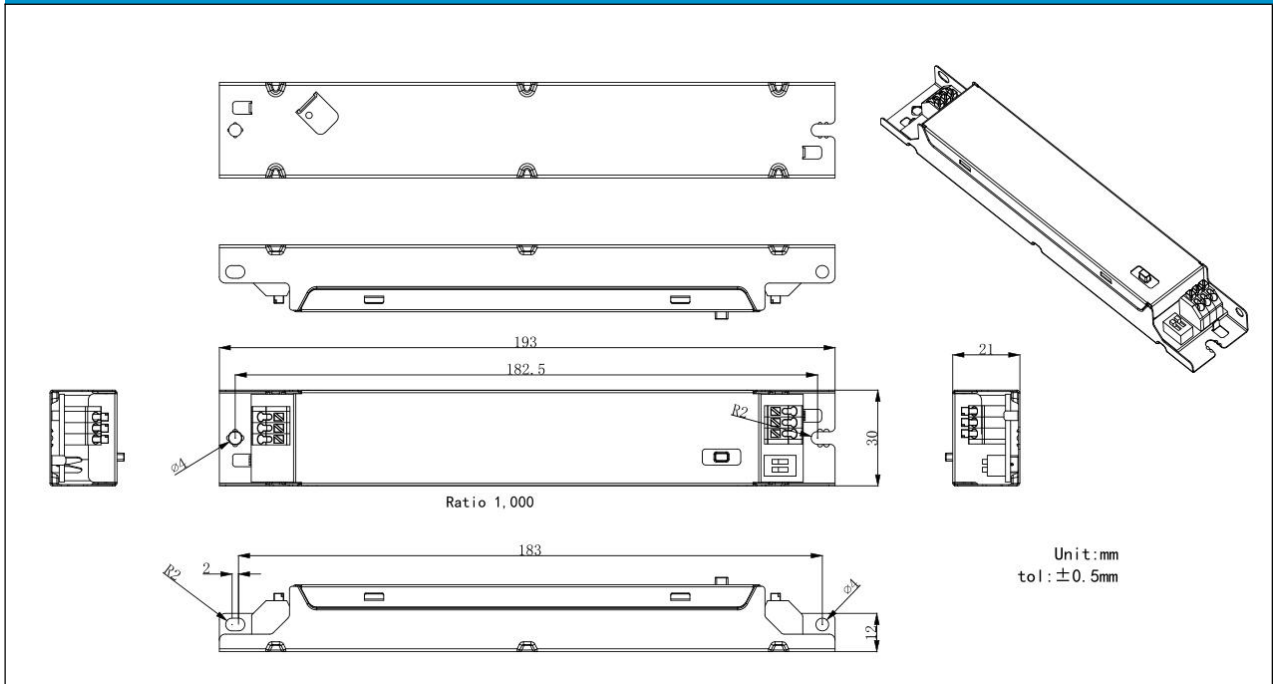

WIRING DIAGRAM

- 1、 All connections must be as short as possible to ensure good EMI performance
- 2、 The lamp wire should keep a certain distance from the LED power supply and other wires (5-10cm is preferred).
- 3、 No secondary switches are allowed
- 4、 Incorrect wiring can damage leds
- 5、 The wire must be well protected against short circuit

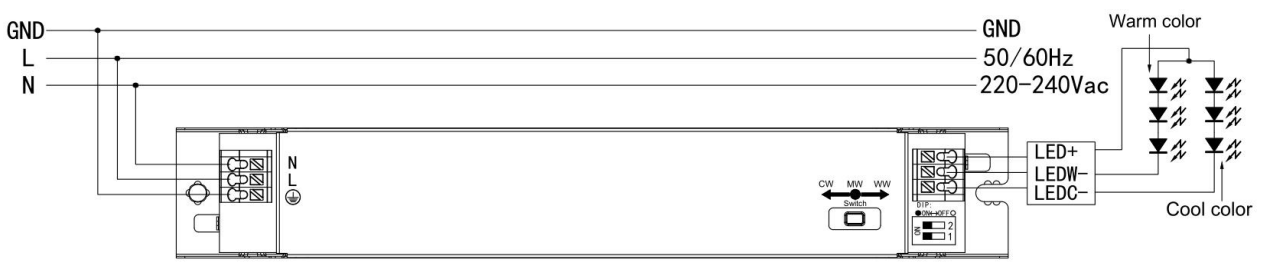

Adjustable Output Current with dip-switch



lout	1	2
200mA	OFF	OFF
250mA	OFF	ON
300mA	ON	OFF
350mA	ON	ON

Tel:+86-755-27819400 Fax:+86-755-27819401

Add:Floor 6, building C, guangxingyuan Internet intelligent technology park, xin'an fourth road, baoan 7/4 district, shenzhen



TECHNICAL INFORMATION

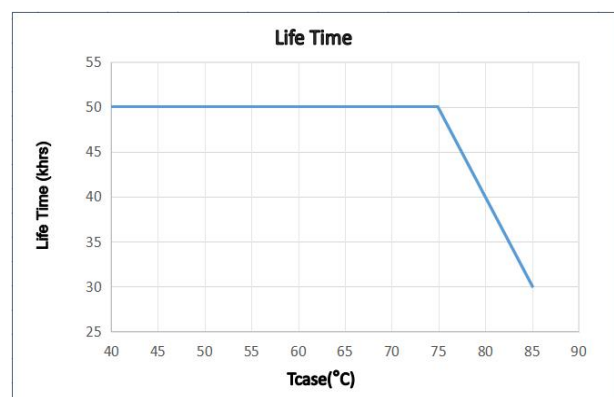
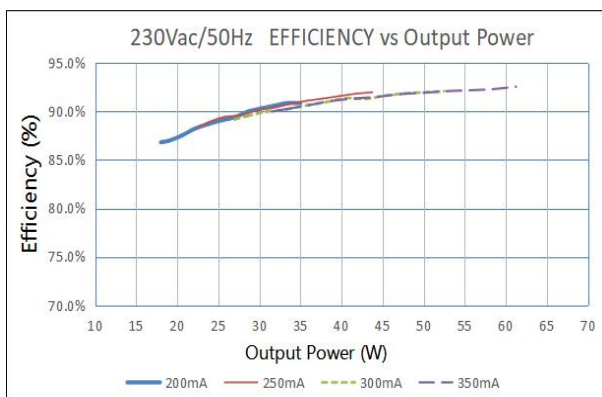
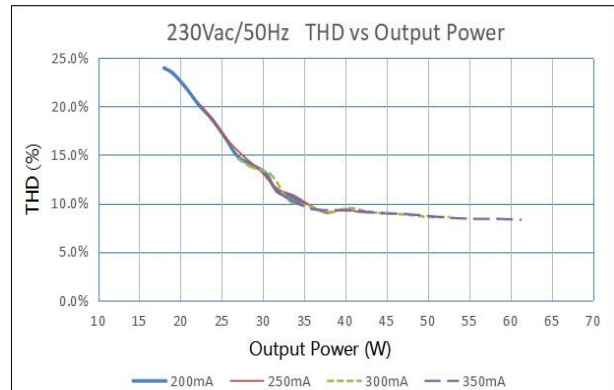
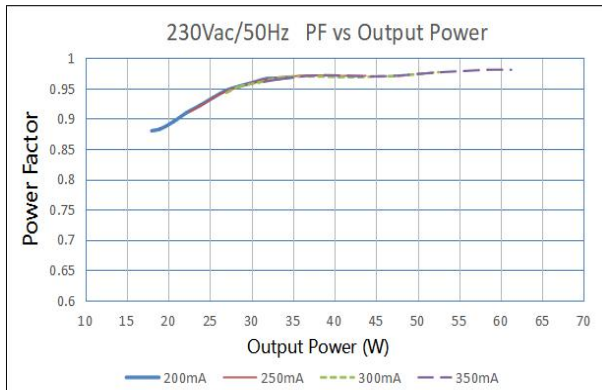

Tel:+86-755-27819400 Fax:+86-755-27819401

Add:Floor 6, building C, guangxingyuan Internet intelligent technology park, xin'an fourth road, baoan 74 district, shenzhen